

**WANG**

# **PRICING MANUAL**

**Company  
Confidential**

**Effective: May 1, 1984**

G MODEM	WANGNET	7500T	MAILWAY®	WANG OFFICE	VS	2200	WP/OIS
CODES	TRE	SPEC PROD	CUSTOMER ENGINEERING	GEN INFO	PIC	PC	DVX

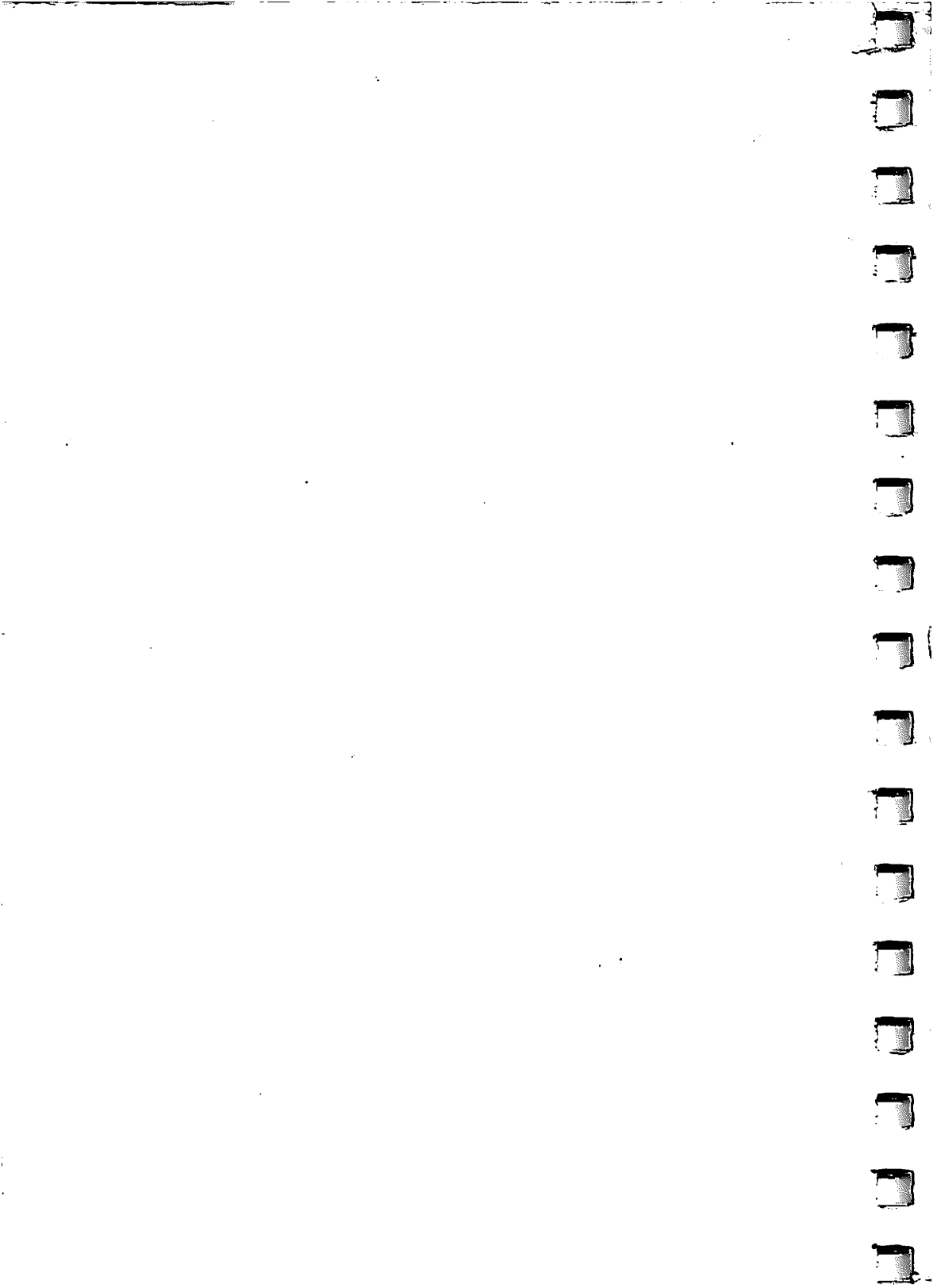

WANG LABORATORIES, INC.  
ONE INDUSTRIAL AVENUE, LOWELL, MA 01851 • TEL. 617/459-5000, TWX 710-343-6760, TELEX 94-7421

TO: ALL U.S. PRICING MANUAL USERS  
FROM: PRICE LIST ADMINISTRATION  
SUBJECT: WANG PRICING MANUAL UPDATE  
DATE: MAY 1, 1984

**WANG**

Attached is the May 1, 1984 Pricing Manual. Please note that the entire manual has been updated. Please destroy all previous updates. Pricing Manuals are updated every three months.

To avoid confusion please read this memo thoroughly and attach it to your current pricing manual for reference.

If you need to order additional copies of the manual a request must be submitted by the Branch, District or Department Manager, on an Internal Literature Withdrawal Form to the Literature Stockroom, M/S 1160. To keep an accurate record of stock, this form must be used to order the manual updates. NO PHONE ORDERS, MEMOS, ETC. WILL BE ACCEPTED.

To order the May 1 update, please use the following control number:

May 1, 1984                      700-6629M

The first page of text is the Master Table of Contents. This shows all the sections and their relative locations within the package. At the bottom of each page, except for the Master Table of Contents, is a footer. An example is as follows:

WP/OIS/ 1-5                      COMPANY CONFIDENTIAL  
REPLACES: 02/01/84  
EFFECTIVE: 05/01/84

Each page has an unique page number. In this case the page number is:

WP/OIS/ 1-5

This breaks down as follows:

WP/OIS identifies the PRODUCT LINE

1-5                      Is the PAGE NUMBER within the specific Product Line price list. the number 1 specifies the Section, which in this case is the WP/OIS and the number 5 specifies the page number.

As you will notice, the first page of your pricing manual is a Master Table of Contents. This section denotes the sections that should be contained in your pricing manual, the order in which they should appear, and the effective date. This allows you to cross reference with the Table of Contents page of each section, to ensure that you have the most up to date section. A new Master Table of Contents will be included with each revision package.

The Table of Contents at the front of each section denotes the specific pages that should be included in the section, the latest revision of the specified pages (the date is shown in the footer for each page), and their specific order.

0532t

WANG

COMPANY CONFIDENTIAL

**WANG**

LABORATORIES, INC.

ONE INDUSTRIAL AVENUE, LOWELL, MASSACHUSETTS 01881, TEL. (617) 458-5000, TWX 710 343-8789, TELEX 94-7421

**PRICE LIST****50 STATES AND DISTRICT OF COLUMBIA**

F.O.B. Tewksbury, Mass. All Taxes Additional. Prices Subject to Change Without Notice.  
For Alaska: Add 10% to all Equipment and Maintenance Prices.  
For Puerto Rico: Add 4% to all Equipment Prices.

COMPANY CONFIDENTIAL

PRICING MANUAL TABLE OF CONTENTS

Effective Date: MAY 1, 1984

TABLE OF CONTENTS

DESCRIPTION	SECTION	EFFECTIVE DATE	PAGE NUMBERING SCHEME
WP/OIS PRODUCT LINE	1	05/01/84	WP/OIS/ 1 - #
2200 PRODUCT LINE	2	05/01/84	2200/ 2 - #
VS PRODUCT LINE	3	05/01/84	VS/ 3 - #
WANG OFFICE PRODUCT LINE	4	05/01/84	WO/ 4 - #
HAILWAY <sup>®</sup> PRODUCT LINE	5	05/01/84	HW/ 5 - #
7500T PRODUCT LINE	6	05/01/84	7500T/ 6 - #
WANGNET PRODUCT LINE	7	05/01/84	WN/ 7 - #
WANG WA3451 MODEM PRODUCT LINE	8	05/01/84	WM/ 8 - #
DVX PRODUCT LINE	9	05/01/84	DVX/ 9 - #
PROFESSIONAL COMPUTER PRODUCT LINE	10	05/01/84	PC/ 10 - #
PROFESSIONAL IMAGING COMPUTER PRODUCT LINE	11	05/01/84	PIC/ 11 - #
GENERAL INFORMATION	12	05/01/84	GEN. INFO./ 12 - #
CUSTOMER ENGINEERING	13	05/01/84	C.E./ 13 - #
SPECIAL PRODUCTS	14	05/01/84	SP/ 14 - #
TRADITIONAL RENTAL EQUIPMENT	15	05/01/84	TRE/ 15 - #
SIC CODE LISTINGS	16	05/01/84	SIC/ 15 - #

WANG

COMPANY CONFIDENTIAL

U.S. PRODUCT LINE ADDITIONS AND CHANGES SINCE FEBRUARY 1, 1984 PRICING MANUAL

**WP/OIS**

**ADDITIONS**

<u>MODEL</u>	<u>PURCHASE PRICE</u>	<u>MAINTENANCE PRICE</u>
OIS-50A	8700	83
OIS-60	9000	127
OIS-60A	11700	145
OIS-50 MOIS-3	400	N/A
OIS-50 MPOIS-3	600	N/A
6529-9	4500	N/A
HPALL	600	N/A
UNI/KBD-US	525	N/A
BFT-55	300	N/A
WILS-WP-OIS-SW9	500	N/A
WILS-GL-PROGRAM	2000	N/A
WILS-GL-DISCS	2100	N/A
WILS-GL-DISC1	700	N/A
WILS-GL-DISC2	700	N/A
WILS-GL-DISC3	700	N/A
WILS-GL-OIS-SW	200	N/A
WILS-GL-OIS-SW9	200	N/A
WILS-GL-VS-SW	200	N/A
WILS-STDKEYS	15	N/A
WILS-UNIKKEYS	15	N/A
WILS-PULLER	15	N/A
WILS-STDCOVER	10	N/A
WILS-UNICOVER	10	N/A
WILS-GL-LEARNER	50	N/A
WILS-ADMIN	25	N/A
UJ-1292	6200	
UJ-1293	4500	
UJ-1294	6700	
UJ-1295	5000	
PC-55001	200	
UJ-1273	750	
UJ-1274	250	
UJ-1276	625	
UJ-1277	375	
UJ-1278	375	
UJ-1279	500	
UJ-1280	500	
UJ-1281	500	

**CHANGES**

6529	FROM	6000	
	TO	4500	
6581W-1	FROM	5000	
	TO	6000	
4230TC	FROM		24
	TO		32
DSF-55	FROM	1895	
	TO	2000	

**DELETIONS**

6581W	5,000	49
6581WC	7,000	49
5541W	4,000	49
5541WC	5,000	49
AL-READ	3,000	30
5300SD/OIS-STD	525	N/A
200-4057-06	15	N/A
200-4101-06	15	N/A
725-2806	15	N/A
449-0745	10	N/A
449-0846	10	N/A
UJ-1257	500	
UJ-1275	750	

WANG

COMPANY CONFIDENTIAL



## 2200

ADDITIONS

<u>MODEL</u>	<u>PURCHASE PRICE</u>	<u>MAINTENANCE PRICE</u>
MVP-P4	18000	247
MVP-P5	19000	277
2275-30	6500	65
2275-60	8500	97
UJ-5054	4000	
UJ-5055	5500	

CHANGES

2282	FROM 3600 TO 4140	
2229	FROM 6000 TO 4500	

DELETIONS

2282	4140	19	(moved to Special Products)
------	------	----	-----------------------------

VSADDITIONS

<u>MODEL</u>	<u>PURCHASE PRICE</u>	<u>MAINTENANCE PRICE</u>
VS85-76F	70000	482
VS85-147F	77000	508
VS300-4	170000	976
VS300-8	202000	1176
VS300-12	234000	1376
VS300-16	266000	1576
VS300-CC	2000	N/A
VS300-FPU	10000	80
VS300-BB	7000	70
VS300-RD	N/A	125
VS-6550	2200	20
23V97	5000	69
23V96	10000	152
23V95-1	4500	32
23V95-2	5500	42
23V98-1	7500	62
23V98-2	8500	77
23V98-3	9500	92
23V98-4	10500	107
UJ-3288	1500	
UJ-3289	3000	
UJ-3290	4500	
UJ-3291	1500	
UJ-3292	3000	
UJ-3293	1500	
UJ-3283	40000	
UJ-3284	40000	
UJ-3285	40000	
WILS-UNIKES	15	N/A
WILS-PULLER	15	N/A
WILS-STDCOVER	10	N/A
195-2826-X	2200	N/A
OFH-1-X	5000	42
4200-AC002	125	N/A
2375V-C1	28000	134
2375V-1	25000	124
2267V-1	12000	160
DH/OS-55	5000	43
BFT-55	300	N/A
DSF-55	2000	N/A
220-3309-07	315	
220-3309-20	410	
220-3309-21	540	
220-3308-21	315	

VS

**ADDITIONS (continued)**

<u>MODEL</u>	<u>PURCHASE PRICE</u>	<u>MAINTENANCE PRICE</u>
220-3308-22	410	
220-3308-33	540	
220-3041-29	315	
220-3041-30	410	
220-3041-31	540	
220-3033-43	315	
220-3033-44	410	
220-3033-45	540	
220-3390	220	
UJ-3242	1400	

**CHANGES**

VS25B	FROM		159
	TO		135
VS25D	FROM		256
	TO		232
VS25BN	FROM		181
	TO		157
VS25DN	FROM		284
	TO		260
VS45E	FROM		380
	TO		364
VS45F	FROM		474
	TO		433
VS45G	FROM		522
	TO		498
VS45GN	FROM		462
	TO		438
VS85E	FROM		596
	TO		572
VS85F	FROM		665
	TO		641
VS85G	FROM		730
	TO		706
2529V	FROM	6000	
	TO	4500	
6581W-1	FROM	5000	
	TO	6000	
DSF-55	FROM	1895	
	TO	2000	
VS-AL-WP-PLUS	FROM	12000	
	TO	13000	

**DELETIONS**

195-2122-X	4500	N/A
195-2122-MSL	2700	N/A
195-2122-STD	N/A	59
195-2122-CSS	N/A	24
VS-AL-READ-X	3000	25
IIS-DOCBLDR-X	1000	9
5300KBD/DP-STD	525	N/A
6581W	5000	49
6581WC	7000	49
200-4057-Q6	15	N/A
200-4101-Q6	15	N/A
72E-2806	15	N/A
449-0745	10	N/A

VS

DELETIONS (continued)

<u>MODEL</u>	<u>PURCHASE PRICE</u>	<u>MAINTENANCE PRICE</u>
449-0846	10	N/A
UJ-3221-X	6000	
UJ-3222-X	10000	
UJ-3223-X	22000	
UJ-3225-X	12000	
UJ-3226-X	24000	
UJ-3228-X	4000	
UJ-3229-X	16000	
UJ-3231-X	8000	
UJ-3232-X	20000	
UJ-3233-X	6000	
UJ-3234-X	10000	
UJ-3235-X	20000	
UJ-3236-X	12000	
UJ-3237-X	24000	
UJ-3238-X	12000	

Z500T

ADDITIONS

<u>MODEL</u>	<u>PURCHASE PRICE</u>	<u>MAINTENANCE PRICE</u>
75PC-PM40T	1215	10
75PC-PM42T	675	10
PC-SS005	240	N/A
PC-SS015	295	N/A
PC-SS016	395	N/A
PC-SS022	1500	N/A
PC-SS023	150	N/A
PC-SS060	200	N/A
PC-SS062	400	N/A
PC-SS063	400	N/A
PC-WSNT-MS	250	N/A
PC-WSNT-PP	250	N/A
PC-WSNT-X25	250	N/A
PC-WSNS-B55	100	N/A
195-2701-9	200	N/A
PC-AS009	495	N/A
PC-AS012	295	N/A
PC-CS003	1750	N/A
QTS-WP-PLUS	2000	17
AL-WP-PLUS	2000	17
ALI-WSNT-MS	1000	10
ALI-WSNT-PP	1500	15
DSF-IIT	2100	27
UJ-1267	1810	

CHANGES

PC-SS001	FROM	100
	TO	200
UJ-3199	FROM	50
	TO	100
UJ-3200	FROM	100
	TO	150

DELETIONS

AL-READ	3000	30
UJ-1275	750	

CONFIDENTIAL

WANGHEI

ADDITIONS

<u>MODEL</u>	<u>PURCHASE PRICE</u>	<u>MAINTENANCE PRICE</u>
FASTLAN-A	995	20
FASTLAN-B	350	6
FASTLAN-C	120	N/A
FASTLAN-AT	1300	20
FASTLAN-BT	800	6
FASTLAN-CT	180	N/A
FASTLAN-ENC	640	N/A

DVX

ADDITIONS

<u>MODEL</u>	<u>PURCHASE PRICE</u>	<u>MAINTENANCE PRICE</u>
6545A	38000	388
EM-OIS	2000	25
TC-5536-4	5000	47
6565	18000	255
6580-3	13000	186
5533-1	3500	46
OIS-BASIC-9	1500	5

PIC

ADDITIONS

<u>MODEL</u>	<u>PURCHASE PRICE</u>	<u>MAINTENANCE PRICE</u>
PIC-AS009	150	2

SPECIAL PRODUCT

ADDITIONS

<u>MODEL</u>	<u>PURCHASE PRICE</u>	<u>MAINTENANCE PRICE</u>
9094	2300	20
9095	2300	20

CHANGES

900S-2	FROM 1000 TO 1200
9020-24	FROM 750 TO 900
9044	FROM 1000 TO 1200
9048	FROM 2000 TO 2300
9049-11	FROM 250 TO 300
9049-31	FROM 250 TO 300
9064-1	FROM 3500 TO 4025
9068	FROM 4500 TO 5175
9069	FROM 50 TO 60

SPECIAL PRODUCT

<u>MODEL</u>	<u>PURCHASE PRICE</u>	<u>MAINTENANCE PRICE</u>
<u>CHANGES</u>		
9069-1	FROM 75 TO 90	
9069-2	FROM 90 TO 108	
9069-3	FROM 100 TO 120	
9080	FROM 700 TO 840	
2250	FROM 400 TO 480	
2252A	FROM 600 TO 720	
2254	FROM 750 TO 900	
2282	FROM 3600 TO 4140	
9038-A	FROM 5000 TO 6000	
9038-B	FROM 5000 TO 6000	
9038-C	FROM 5000 TO 6000	
9038-D	FROM 5000 TO 6000	
9038-F	FROM 5000 TO 6000	
9038-LN	FROM 5000 TO 6000	
9038-LP	FROM 5000 TO 6000	
9038-LT	FROM 5000 TO 6000	
9038-M	FROM 5000 TO 6000	
9038-P	FROM 5000 TO 6000	
9038-T	FROM 5000 TO 6000	
9038-V	FROM 5000 TO 6000	
9049-14	FROM 250 TO 300	
9065	FROM 2600 TO 2990	
9067	FROM 6200 TO 6800	
9512-01	FROM 150 TO 180	

WANG

COMPANY CONFIDENTIAL

SPECIAL PRODUCT

<u>MODEL</u>	<u>PURCHASE PRICE</u>	<u>MAINTENANCE PRICE</u>
<b>CHANGES</b>		
9512-02	FROM 150 TO 180	
9072	FROM 1200 TO 1440	
9072-1	FROM 1200 TO 1440	
PTP-3	FROM 5200 TO 5720	
PTP-3-0P	FROM 950 TO 1045	
9057-VS1	FROM 1500 TO 1800	
9074	FROM 2600 TO 3000	
9075-V2	FROM 3000 TO 3450	
9075-V3	FROM 3000 TO 3450	
9082	FROM 500 TO 600	
9082-1	FROM 1000 TO 1200	
9085	FROM 500 TO 600	
9085-1	FROM 1500 TO 1800	
9088	FROM 3000 TO 3450	

DELETIONS

9057	750	8
9086	2000	20
9087	2000	20

PC

ADDITIONS

<u>MODEL</u>	<u>PURCHASE PRICE</u>	<u>MAINTENANCE PRICE</u>
PC-PK1	5995	17
PC-006	8070	70
PC-XC4	6940	59
PC-PH022	1995	41
PC-PK2-DA	3260	13
PC-PK2-VS	3260	13
PC-PH041-DA	2000	8
PC-PH041-VS	2000	8
PC-PH014	2995	43
PC-PH048	900	8
SSF-20	500	10
BFT-20	275	N/A
PC-PH075	800	8
PC-SS036	200	N/A
PC-SS065	240	N/A
PC-VT500	250	N/A
PC-AS014	150	2

WANG  
COMPANY CONFIDENTIAL

PC

**ADDITIONS**

<u>MODEL</u>	<u>PURCHASE PRICE</u>	<u>MAINTENANCE PRICE</u>
PC-CS002	700	N/A
PC-CS004	850	N/A

**CHANGES**

PC-004A	FROM 4030 TO 4090
PC-005A	FROM 6400 TO 6460
PC-PM002	FROM 240 TO 300
UJ-3200	FROM 100 TO 150

**DELETIONS**

PC-PM041	2000
----------	------

8

**WANG OFFICE**

**CHANGES**

<u>MODEL</u>	<u>PURCHASE PRICE</u>	<u>MAINTENANCE PRICE</u>
OFM-1-3	5000	42

**DELETIONS**

UJ-3221-X	6000
UJ-3222-X	10000
UJ-3223-X	22000
UJ-3225-X	12000
UJ-3226-X	24000
UJ-3228-X	4000
UJ-3229-X	16000
UJ-3231-X	8000
UJ-3232-X	20000
UJ-3233-X	6000
UJ-3234-X	10000
UJ-3235-X	20000
UJ-3236-X	12000
UJ-3237-X	24000
UJ-3238-X	12000

WANG  
CONFIDENTIAL

WARE

COMPANY CONFIDENTIAL



COMPANY CONFIDENTIAL

Effective Date: MAY 1, 1984

-Prices and equipment availability subject to change without notice-  
 WORD PROCESSING AND OFFICE INFORMATION SYSTEMS PRODUCT LINE PRICE LIST

TABLE OF CONTENTS

DESCRIPTION	PAGE	EFFECTIVE DATE
<b>WANGWRITER</b>		
Software	2	05/01/84
<b>WORD PROCESSING SYSTEMS</b>		
Software	3	05/01/84
<b>OFFICE INFORMATION SYSTEMS</b>		
System 40, 50, 60 Hardware	4	05/01/84
System 40, 50, 60 Software ONLY	7	05/01/84
Master Units	8	05/01/84
Master Options	8	05/01/84
OIS/ALLIANCE Additional Disk Storage	9	05/01/84
WP5/OIS Input/Output Peripherals	9	05/01/84
Optional Software	9	05/01/84
Data Communications Software	10	05/01/84
<b>ALLIANCE SYSTEMS</b>		
Master Units	12	05/01/84
Optional Software	12	05/01/84
<b>OPTIONS</b>		
Data Communications	14	05/01/84
OIS/ALLIANCE Data Commn. Components	15	05/01/84
Null Modems	16	05/01/84
<b>WORKSTATIONS</b>		
WP/OIS/ALLIANCE	16	05/01/84
Remote WangNet WP/DP	16	05/01/84
4200 Series	17	05/01/84
5300 Series Ergonomic	18	05/01/84
6300 Series Graphics	19	05/01/84
Communications	20	05/01/84
Options	20	05/01/84
<b>PRINTERS</b>		
System 20, 25-3, 30, All OIS	20	05/01/84
OIS	21	05/01/84
Alliance, OIS-40/50/60	21	05/01/84
Options	22	05/01/84
<b>WILLS - WANG INTERACTIVE LEARNING SYSTEMS</b>	26	05/01/84
<b>UPGRADES</b>		
Introduction	29	05/01/84
General Information	30	05/01/84
Wangwriter	31	05/01/84
Upgrade Exchanges	32	05/01/84
Quantity Discounts for Workstation Upgs.	39	05/01/84
Upgrade Pricing	42	05/01/84
<b>TRADE-IN POLICY</b>	51	05/01/84
<b>CONFIGURATION GUIDES</b>	53	05/01/84
<b>ENTITLEMENT SUMMARIES</b>	73	05/01/84

INSTALLATION CHARGE

There is no installation charge for initial installation of system(s). For add-on equipment or upgrades that are not designated customer-installable there is an installation charge of 3% of the purchase price - minimum charge \$100 per order.

NOTE: All orders for add-ons and upgrade equipment MUST include the work order numbers and serial numbers of the system components involved.

WANG

COMPANY CONFIDENTIAL

MODEL  
NUMBER

DESCRIPTION

PURCHASE  
PRICEMONTHLY  
MAINTENANCE-----MONTHLY RENTAL PRICES-----  
1 YEAR 2 YEAR 3 YEAR 5 YEARWANGWRITER

All Wangwriters include a Workstation with movable keyboard, Printer Console with Single or Dual Diskette Drive and 20 CPS Printer. Discounts are allowed for quantity purchases (sales only; no rentals except as noted on exception basis\*). Orders must be submitted on a single purchase order, delivery may be to multiple delivery points, but must be within six (6) months of initial order. Quantity discounts are applied per model number not on an aggregate basis except as noted on an exception basis\*. Products for which Wang publishes multi-unit discounts shall receive the higher of the applicable published multi-unit quantity discount, or the Annual Volume Agreement discount, but not both.

IN ORDER TO TAKE ADVANTAGE OF THE NEW WANGWRITER EXPEDITED BOOKING PROCESS YOU MUST CALL THE FOLLOWING NUMBERS: 1-800-225-0978 OR IN MA, AK, HI, (617)453-7069.

		QUANTITY ORDERED	DISCOUNT					
		1 - 1	0%					
		2 - 9	5.1%					
		10 - 19	10.1%					
		20 - 49	15.1%					
		50 - 99	22.1%					
		100 +	27.3%					
5524D	Wangwriter II with 128K Memory and dual minidiskette	\$ 5,995	\$ 87	\$ 362	\$ 355	\$ 339	\$ 308	
TC-5524D	Wangwriter II with 128K Memory and dual minidiskette with TC	6,745	106	407	400	382	347	

WANGWRITER SINGLE SHEET FEEDERS

WW-SSF-1	Single Sheet Feeder for Wangwriter 8 1/2" x 11" or 21.59cm x 27.94cm paper	\$ 1,150	\$ 15	\$ 55	\$ 53	\$ 51	\$ 46	
----------	--	----------	-------	-------	-------	-------	-------	--

MODEL  
NUMBER

DESCRIPTION

INITIAL  
LICENSE  
FEEMONTHLY  
LICENSE  
FEE-----MONTHLY RENTAL PRICES-----  
1 YEAR 2 YEAR 3 YEAR 5 YEARWANGWRITER SOFTWARE

WW-EFP-II	Enhanced functions package for 5504D and 5524D (195-2441-9)	\$ 250	N/A	N/A	N/A	N/A	N/A	
W4-FTC-TTE	Teletype Emulation for 5504S/D and 5524S/D (195-2215-3)	375	N/A	N/A	N/A	N/A	N/A	
W4-FTC-BATCH	2780/3780 Emulation for 5504S/D and 5524S/D (195-2216-3)	375	N/A	N/A	N/A	N/A	N/A	
W4-FTC-2236	2200/2236DE Interactive Terminal Emulation for 5504S/D and 5524S/D (195-2259-3)	200	N/A	N/A	N/A	N/A	N/A	

NOTE: All orders for add-ons and upgrade equipment MUST include the work order numbers and serial numbers of the system components involved.

WP/OIS/ 1 - 2

COMPANY CONFIDENTIAL  
REPLACES: 02/01/84  
EFFECTIVE: 05/01/84

WP/OIS

MODEL NUMBER	DESCRIPTION	INITIAL LICENSE FEE	MONTHLY LICENSE FEE	-----MONTHLY RENTAL PRICES-----			
				1 YEAR	2 YEAR	3 YEAR	5 YEAR
<u>WANGWRITER SOFTWARE</u> (continued)							
WW-CP/M-II	WW-CP/M-II for Wangwriter 5503A/D, 5504S/D and 5524S/D (195-2442-9)	\$ 200	N/A	N/A	N/A	N/A	N/A
WW-MULTI	Multiplan Electronic Spread Sheet Program for 5503A/D, 5504S/D, and 5524S/D (195-2342-9)	300	N/A	N/A	N/A	N/A	N/A
<u>WPS SOFTWARE</u>							
SO-1	Sort Option (701-2395)	\$ 1,000	N/A	\$ 47	\$ 46	\$ 44	40
SO-2	Math Support Package(701-2396)	1,000	N/A	47	46	44	40
SO-3	System Security (Not an optional Software Package for WPS 7524-3T) (701-2397)	2,000	N/A	94	92	88	80
SO-4	System Security without On-Line Diagnostics (GSA Customers only) (701-2398)	2,000	N/A	94	92	88	80

NOTE: All orders for add-ons and upgrade equipment MUST include the work order numbers and serial numbers of the system components involved.

MODEL  
NUMBER

DESCRIPTION

PURCHASE  
PRICEMONTHLY  
MAINTENANCE-----MONTHLY RENTAL PRICES-----  
1 YEAR 2 YEAR 3 YEAR 5 YEAROIS 40/50/60

## Hardware

All 64K OIS printers are also supported in the OIS-40, OIS-50 and 60

MODEL NUMBER	DESCRIPTION	PURCHASE PRICE	MONTHLY MAINTENANCE	1 YEAR	2 YEAR	3 YEAR	5 YEAR
OIS-40	OIS-40 Master, 10MB fixed disk, 5 1/4" diskette drive, 1 internal workstation	\$ 6,200	\$ 63	\$ 441	\$ 410	\$ 360	292
OIS-40B	OIS-40 Master, 10MB fixed disk, 5 1/4" diskette drive, internal workstation, 20 CPS Daisy Printer with internal printer controller board	8,200	88	549	510	446	372
OIS-50	OIS-50 Master, 10MB fixed disk, 5 1/4" diskette drive	6,000	65	390	366	318	258
OIS-50A	OIS-50 Master, 10MB fixed disk, 5 1/4" diskette drive, 1 Internal Workstation	8,700	83	536	501	435	366
OIS-60	OIS-60 master, 33.5MB fixed disk, 5 1/4" diskette drive Standard OIS WP software	9,000	127	720	660	490	450
OIS-60A	OIS-60 master, 33.5MB fixed disk, 5 1/4" diskette drive, 1 Internal Workstation Standard OIS WP software	11,700	145	866	795	607	558
OIS-IWS	Internal Workstation, CRT, keyboard, base, internal board (OIS 50/60)	2,700	18	146	135	117	108
OIS-PTR20	20cps printer with internal printer controller board	2,000	25	108	100	86	80
OIS-IWISE	Two-port internal WISE board	1,300	10	71	65	56	52

NOTE: All orders for add ons and upgrade equipment MUST include the work order numbers and serial numbers of the system components involved.

WP/OIS/ 1 - 4

COMPANY CONFIDENTIAL  
REPLACES: 02/01/84  
EFFECTIVE: 05/01/84

WP/OIS

MODEL NUMBER	DESCRIPTION	PURCHASE PRICE	MONTHLY MAINTENANCE	-----MONTHLY RENTAL PRICES-----			
				1 YEAR	2 YEAR	3 YEAR	5 YEAR

DATA COMMUNICATIONS COMPONENTS

The Data Communications Controllers are installed either internally in any OIS master, or in the external chassis OIS-6554. Order the OIS-6554 separately if the DCC is to be installed externally. Each DCC must be ordered with a Connector and Front Panel.

OIS-TC	Data communications controller board (64K); can be upgraded to 128K	\$ 1,500	\$ 25	\$ 81	\$ 75	\$ 65	60
OIS-TC1	Data communications controller board (128K, required for SMA and Teletex)	2,000	33	108	100	86	80

The Network interface provides the physical connection from the DCC to the Network interface, including the appropriate 25-foot cable.

Please note that while the DCC hardware could support all of the physical connection types if given the appropriate connectors, the communications software may not. Consult the software matrix for compatibility issues.

CN-RS232-9	Connector for RS-232 or CCITT V.24 modem support for OIS-TC options, OIS-40/50 ONLY	150	N/A	N/A	N/A	N/A	N/A
CN-RS366-9	Connector for RS-366 or CCITT V.25 auto dial support for OIS-TC options, OIS-40/50 ONLY	150	N/A	N/A	N/A	N/A	N/A
OIS-FP50	Front panel for OIS 40/50/60 - one board supported (Required for OIS-TC or OIS-TC1)	150	N/A	N/A	N/A	N/A	N/A

NOTE: All orders for add-ons and upgrade equipment MUST include the work order numbers and serial numbers of the system components involved.

MODEL  
NUMBER

DESCRIPTION

INITIAL  
LICENSE  
FEE

MONTHLY  
LICENSE  
FEE

-----MONTHLY RENTAL PRICES-----  
1 YEAR 2 YEAR 3 YEAR 5 YEAR

Discounts are allowed for quantity purchases (sales only: no rentals except as noted on exception basis\*). Orders must be submitted on a single purchase order, delivery may be to multiple delivery points, but must be within six (6) months of initial order. Quantity discounts are applied per model number not on an aggregate basis except as noted on an exception basis\*. Products for which Wang publishes multi-unit discounts shall receive the higher of the applicable published multi-unit quantity discount, or the Annual Volume Agreement discount, but not both.

THIS DISCOUNT SCHEDULE APPLIES TO ALL OIS AND ALLIANCE SOFTWARE UNLESS NOTED DIFFERENTLY:

QUANTITY ORDERED DISCOUNT

1 - 2 0%  
3 - 5 10%  
6 - 10 20%  
11 - 20 30%  
OVER 20 40%

OIS 40/50/60 (ONLY) SOFTWARE

MODEL NUMBER	DESCRIPTION	INITIAL LICENSE FEE	MONTHLY LICENSE FEE	1 YEAR	2 YEAR	3 YEAR	5 YEAR
OIS-BASIC-9	Office BASIC Compiler (195-2518-9)	\$ 1,500	\$ 5	\$ 81	\$ 75	\$ 65	60
OIS-SPELL-9	Spelling Verifier, 89,000 Word Dictionary (195-2519-9)	1,000	10	54	50	43	40
OIS-SMSPELL-9	Spelling Verifier, 30,000 Word Dictionary (195-2520-9)	500	5	27	25	22	20
OIS-CHARTER-9	Graphics Software (195-2521-9)	1,000	10	54	50	43	40
OIS-LIST-9	List Processing (195-2522-9)	1,300	10	71	65	56	52
OIS-SLP-9	Small List Processing (195-2523-9)	750	5	41	38	33	30
OIS-READ-9	Readability Index Generator (195-2526-9)	1,000	10	54	50	43	40
OIS-SCI-TY-9	Scientific Typing Software (195-2527-9)	500	5	27	25	22	20
OIS-DOCBLDR-9	Paragraph Retrieval Software (195-2528-9)	500	5	27	25	22	20
OIS-CPM-9	CP/M Software (195-2524-9)	300	3	17	15	13	12

OIS 40/50/60 EDITOR PACKAGE

OIS-WP-PLUS-9	Optional Advanced Word Processing Package for OIS 40/50/60	\$ 2,000	\$ 17	\$ 110	\$ 102	\$ 88	80
---------------	--	----------	-------	--------	--------	-------	----

NOTE: All orders for add-ons and upgrade equipment MUST include the work order numbers and serial numbers of the system components involved.

MODEL NUMBER	DESCRIPTION	INITIAL LICENSE FEE	MONTHLY LICENSE FEE	-----MONTHLY RENTAL PRICES-----			
				1 YEAR	2 YEAR	3 YEAR	5 YEAR
<u>OIS 40/50/60 (ONLY) SOFTWARE WITHOUT QUANTITY DISCOUNTS</u>							
OIS-MULTI-9	Multiplan Electronic Spread Sheet (Requires OIS-CPM-9) (195-2525-9)	\$ 300	\$ 3	\$ 17	\$ 15	\$ 13	12
OIS-3271E-9	3271 Emulation (Requires OIS-TC) (195-2531-9)	1,500	15	81	75	65	60
OIS-BATCH-9	2780/3780, WPS Communications (Requires OIS-TC) (195-2532-9)	750	8	41	38	33	30
OIS-TTE-9	Teletype Emulation Software (Requires OIS-TC) (195-2533-9)	500	5	27	25	22	20
OIS-SNA-9	SNA 3274 Emulation Software (Requires OIS-TC1)(195-2545-9)	2,000	20	108	100	86	80
<u>OIS 40/50/60 NETWORKING SOFTWARE WITHOUT QUANTITY DISCOUNTS</u>							
OIS-WSNT-MS-9	OIS 40/50/60 Multipoint Secondary Transport	\$ 500	\$ 5	\$ 28	\$ 26	\$ 22	20
OIS-WSNT-PP-9	OIS 40/50/60 Point-Point Transport	1,000	10	55	51	44	40
OIS-WSNT-X25-9	OIS 40/50/60 X.25 Transport	1,000	10	55	51	44	40
OIS-WSMS-LGN-9	OIS 40/50/60 VS Terminal Emulation Service	200	2	11	11	9	8
OIS-WSMS-FT-9	OIS 40/50/60 File Transfer Service	300	3	17	16	14	12
OIS-50 MDIS-3	OIS-50 MDIS-3 Level 3 Distribution Point Glossaries (195-2146-9)	400	N/A	N/A	N/A	N/A	N/A
OIS-50 MPOIS-3	OIS-50 MPOIS-3 Level 3 Distribution Point Software (195-2151-9)	600	N/A	N/A	N/A	N/A	N/A
OIS-OFFICE-9	WANG OFFICE on the OIS/40/50/60	1,000	9	55	51	44	40

QUANTITY DISCOUNTS FOR SOFTWARE

Discounts are allowed for quantity purchases (sales only: no rentals except as noted on exception basis\*). Orders must be submitted on a single purchase order, delivery may be to multiple delivery points, but must be within six (6) months of initial order. Quantity discounts are applied per model number not on an aggregate basis except as noted on an exception basis\*. Products for which Wang publishes multi-unit discounts shall receive the higher of the applicable published multi-unit quantity discount, or the Annual Volume Agreement discount, but not both.

REFER TO THE SOFTWARE QUANTITY DISCOUNT SCHEDULE (PAGE 1-6). ALL SOFTWARE PACKAGES ARE ELIGIBLE UNLESS SPECIFICALLY INDICATED.

NOTE: All orders for add-ons and upgrade equipment MUST include the work order numbers and serial numbers of the system components involved.



MODEL NUMBER	DESCRIPTION	PURCHASE PRICE	MONTHLY MAINTENANCE	-----MONTHLY RENTAL PRICES-----			
				1 YEAR	2 YEAR	3 YEAR	5 YEAR
<u>OIS 100 MASTER UNITS</u>							
6505-1	OIS 105-1 Master, 4.2 MB Disk and Single Diskette	\$ 6,600	\$ 95	\$ 420	\$ 330	\$ 264	240
6515-2	OIS 115-2 Master, 8.4 MB Disk and Single Diskette	11,400	146	660	565	458	416
6515-3	OIS 115-3 Master, 16.0 MB Disk and Single Diskette	14,000	153	847	709	561	510
6515-4	OIS 115-4 Master, 32.0 MB Disk and Single Diskette	16,600	168	1,100	1,030	665	604
6540-3	OIS 140 Model 3 Master, 80.4MB Disk and Single Diskette	26,000	271	1,457	1,426	1,144	1,040
6540-3W	OIS 140 Model 3 Master, 80.4MB Disk and Single Diskette with WangNet interface	26,700	276	1,490	1,459	1,175	1,068
6545A	OIS 145A Master, 275 MB Disk, and Single Diskette	38,000	388	2,090	1,938	1,672	1,520
6545AW	OIS 145A Master, 275MB Disk, Single Diskette with WangNet Interface	38,700	393	1,819	1,781	1,703	1,548

NOTE: The OIS 140-3 and 145A are available with the high altitude option. When ordering these options, add an "HA" to the end of the model number and \$350 to the purchase price.

OIS/ALLIANCE MASTER OPTIONS

6550-1	Wang Inter System Exchange (WISE) (OIS or Alliance)	\$ 5,000	\$ 55	\$ 235	\$ 230	\$ 220	205
EM-OIS	Extended memory option for OIS 100's only (additional 64K) Required for all External File Source (XFS) products, i.e. WISE, 3271, Remote WangNet, etc.	2,000	25	102	96	88	81
6509	9-track, 1600-bpi Tape Drive and Controller (OIS, Alliance)	16,000	137	880	800	704	640
6529	1/4 inch Archiving Cartridge Tape Drive (OIS 100, Alliance)	4,500	53	212	207	198	180
6529-9	1/4 inch archiving cartridge tape drive (OIS 40/50/60)	4,500	53	212	207	198	180

NOTE: All orders for add-ons and upgrade equipment MUST include the work order numbers and serial numbers of the system components involved.

WP/OIS/ 1 - 8

COMPANY CONFIDENTIAL  
REPLACES: 02/01/84  
EFFECTIVE: 05/01/84

WP/OIS

MODEL NUMBER	DESCRIPTION	PURCHASE PRICE	MONTHLY MAINTENANCE	-----MONTHLY RENTAL PRICES-----			
				1 YEAR	2 YEAR	3 YEAR	5 YEAR
<u>OIS/ALLIANCE ADDITIONAL DISK STORAGE</u>							
6565	Optional 275 MB Disk Drive for OIS 140-1,2,3/145A/Alliance	\$ 18,000	\$ 255	\$ 990	\$ 918	\$ 792	720
6565-1	Optional 67 MB Disk Drive for OIS 140-1,2,3/145A/Alliance	12,000	160	660	612	528	480
6580-3	Optional 80.4 MB Disk Drive for OIS 140-1,2,3/145A/Alliance	13,000	186	715	663	572	520

NOTE: Models 6565, 6565-1, 6580-3 are available with the high altitude option. When ordering these options, add an "HA" to the end of the model number and \$350 to the purchase price.

WPS/OIS INPUT PERIPHERALS

OCR-1	OCR Interface	\$ 1,800	\$ 25	\$ 99	\$ 92	\$ 80	72
-------	---------------	----------	-------	-------	-------	-------	----

MODEL NUMBER	DESCRIPTION	INITIAL LICENSE FEE	MONTHLY LICENSE FEE	-----MONTHLY RENTAL PRICES-----			
				1 YEAR	2 YEAR	3 YEAR	5 YEAR

OPTIONAL OIS SOFTWARE WITHOUT QUANTITY DISCOUNTS

SO-6	Office BASIC Compiler (195-2118-3)	\$ 3,000	N/A	\$ 141	\$ 138	\$ 132	120
195-2172-3	Management Statistics System - WP Productivity (OIS 140/145A, 7535T/7540T with 80MB drive only) (195-2172-3)	1,000	N/A	47	46	44	40
OIS-CHARTER	OIS Graphics Software (195-2343-3)	2,000	20	94	92	88	80
OIS-MULTI	Multiplan Electronic Spread Sheet Program for OIS (Requires OIS-CPM) (64K CRT required) (195-2340-3)	600	N/A	N/A	N/A	N/A	N/A

WORLD LANGUAGES WITHOUT QUANTITY DISCOUNTS

195-2388-9	World Languages OIS Special Diskette (195-2388-9) for OIS 40/50/60	\$ 1,000	N/A	\$ 47	\$ 46	\$ 44	40
------------	--	----------	-----	-------	-------	-------	----

OPTIONAL OIS SOFTWARE

OIS-READ	Readability Analysis System (48K or 64K CRT required) (195-2173-3)	\$ 3,000	\$ 30	\$ 141	\$ 138	\$ 132	120
----------	--	----------	-------	--------	--------	--------	-----

NOTE: All orders for add-ons and upgrade equipment MUST include the work order numbers and serial numbers of the system components involved.

MODEL NUMBER	DESCRIPTION	INITIAL LICENSE FEE	MONTHLY LICENSE FEE	-----MONTHLY RENTAL PRICES-----			
				1 YEAR	2 YEAR	3 YEAR	5 YEAR
<u>OPTIONAL OIS SOFTWARE (continued)</u>							
OIS-CPM	CP/M Software for OIS (Requires 64K CRT) (195-2316-3)	\$ 1,000	\$ 10	\$ 47	\$ 46	\$ 44	40
OIS-DOCBUILDER	Paragraph Retrieval Software (Requires 64K CRT)(195-2320-3)	1,000	10	47	46	44	40
SD-8	List Processing for OIS (48K or 64K required) (English Only) (195-2156-3)	1,300	10	62	60	58	52
OIS-SPELL	Software for spelling verification (OIS 115-3/-4, 140/145A, 7515T/7535T/7540T only.) (Requires 64K workstation) (195-2207-3)	1,000	10	47	46	44	40
OIS-SHSPELL	Spelling verification software based on 30,000 word dictionary. Runs on OIS 105, 115-2, 7505T/7515T (Requires 64K workstation) (195-2391-3)	500	5	24	23	22	20
OIS-SLP	Small List Processing for OIS (48K or 64K CRT required) (English Only) (195-2438-3)	750	5	36	35	33	30
OIS-SCI-TY	Scientific Typing Software for OIS (195-2317-3)	750	8	36	35	33	30
<u>OIS EDITOR PACKAGE</u>							
OIS-WP-PLUS	Optional Advanced Word Processing Package for OIS 115-2,-3,-4, 140, 145A (Not available on OIS 105, 125, 125A, 130 and 130A) (195-2760-3)	\$ 2,000	\$ 17	\$ 110	\$ 102	\$ 88	80
<u>OIS DATA COMMUNICATIONS SOFTWARE</u>							
OIS-3271E	3271 Emulation Software (Requires OIS-TC for OIS Systems or TC-SC/AC-2 for 7500T Systems) (195-2243-3)	\$ 2,500	\$ 25	\$ 118	\$ 115	\$ 110	100
OIS-SNA	SNA 3274 Emulation Software (Requires OIS-TC1)(195-2545-3)	2,000	20	108	100	86	80

NOTE: All orders for add-ons and upgrade equipment MUST include the work order numbers and serial numbers of the system components involved.

WP/OIS/ 1 - 10

COMPANY CONFIDENTIAL  
REPLACES: 02/01/84  
EFFECTIVE: 05/01/84

WP/OIS

MODEL NUMBER	DESCRIPTION	INITIAL LICENSE FEE	MONTHLY LICENSE FEE	-----MONTHLY RENTAL PRICES-----			
				1 YEAR	2 YEAR	3 YEAR	5 YEAR
<u>OIS DATA COMMUNICATIONS SOFTWARE</u> (continued)							
OIS-BATCH	2780/3780/WPS Communications (Requires OIS-TC for OIS Systems or TC-SC/AC-2T for 7500T Systems) (195-2619-3)	\$ 1,300	\$ 13	\$ 71	\$ 65	\$ 56	\$ 52
OIS-TTE	Teletype Emulation Software (Requires OIS-TC for OIS Systems or TC-SC/AC-2T for 7500T Systems) (195-2618-3)	1,200	12	65	60	52	48
<u>OIS NETWORKING SOFTWARE</u>							
OIS-WSNT-MS	OIS Multipoint Secondary Transport	\$ 1,000	\$ 10	\$ 55	\$ 51	\$ 44	\$ 40
OIS-WSNT-PP	OIS Point-Point Transport	1,500	15	83	77	66	60
OIS-WSNT-X25	OIS X.25 Transport	1,500	15	83	77	66	60
OIS-WSNT-WB	OIS WangBand Transport	N/A	N/A	N/A	N/A	N/A	N/A
OIS-WSNS-LGM	OIS VS Terminal Emulation Service	400	4	22	21	18	16
OIS-WSNS-FT	OIS File Transfer Service	600	6	33	31	27	24
HOIS-3	Level 3 Distribution Point Glossaries for OIS systems. (195-2146-3)	400	N/A	N/A	N/A	N/A	N/A
HPOIS-3	Level 3 Distribution Point software for OIS systems. (195-2151-3)	600	N/A	N/A	N/A	N/A	N/A
OIS-OFFICE	WANG OFFICE on the OIS	1,000	9	55	51	44	40
QUANTITY DISCOUNTS FOR SOFTWARE							

Discounts are allowed for quantity purchases (sales only; no rentals except as noted on an exception basis\*). Orders must be submitted on a single purchase order, delivery may be to multiple delivery points, but must be within six (6) months of initial order. Quantity discounts are applied per model number not on an aggregate basis except as noted on an exception basis\*. Products for which Wang publishes multi-unit discounts shall receive the higher of the applicable published multi-unit quantity discount, or the Annual Volume Agreement discount, but not both.

REFER TO THE SOFTWARE QUANTITY DISCOUNT SCHEDULE (PAGE 1-6). ALL SOFTWARE PACKAGES ARE ELIGIBLE UNLESS SPECIFICALLY INDICATED.

DATA STREAM FORMAT SPECIFICATIONS

NOTE: Both WPS-CS and WITA require signed License Agreements (WPS-CS 700-8969, WITA 700-8976).

WPS-CS	WPS Document Communication Specification	\$ 500	N/A	N/A	N/A	N/A	N/A
WITA	Wang Information Transfer Architecture	500	N/A	N/A	N/A	N/A	N/A

NOTE: All orders for add-ons and upgrade equipment MUST include the work order numbers and serial numbers of the system components involved.

MODEL NUMBER	DESCRIPTION	PURCHASE PRICE	MONTHLY MAINTENANCE	-----MONTHLY RENTAL PRICES-----			
				1 YEAR	2 YEAR	3 YEAR	5 YEAR

ALLIANCE MASTER UNITS

Includes operation system software license fee and maintenance

6750-1	Alliance 250-1 Master, Includes 128K Memory, 32 Ports, New Alliance operating system Software and 80.4 MB Fixed/Removable Drive	\$ 33,000	\$ 363	\$ 1,786	\$ 1,748	\$ 1,452	\$ 1,320
6750-1W	Alliance 250-1 Master, Includes 128K Memory, 32 Ports, New Alliance operating system Software and 80.4 MB Fixed/Removable Drive. With WangNet interface	33,700	368	1,819	1,781	1,483	1,348
6750-2	Alliance 250-2 Master, Includes 128K Memory, 32 Ports, New Alliance operating system Software and 275 MB Removable Drive	40,000	396	2,491	2,438	1,760	1,600
6750-2W	Alliance 250-2 Master, Includes 128K Memory, 32 Ports, New Alliance operating system Software and 275 MB Removable Drive. With WangNet interface	40,700	401	2,524	2,471	1,791	1,628

NOTE: The Alliance 250-1,-2 are available with the high altitude option. When ordering these options, add an "HA" to the end of the model number and \$350 to the purchase price.

MODEL NUMBER	DESCRIPTION	INITIAL LICENSE FEE	MONTHLY LICENSE FEE	-----MONTHLY RENTAL PRICES-----			
				1 YEAR	2 YEAR	3 YEAR	5 YEAR

OPTIONAL ALLIANCE SOFTWARE

AL-VH	Visual Memory Autodial (Requires audio workstation) (195-2334-3)	\$ 6,000	\$ 60	\$ 282	\$ 276	\$ 264	\$ 240
AL-TIME	Time Management Calendar Directory Autodial (Requires audio workstation) Messaging Voicegrams (Requires audio workstation) (195-2235-3)	2,000	20	94	92	88	80

NOTE: All orders for add-ons and upgrade equipment MUST include the work order numbers and serial numbers of the system components involved.

MODEL NUMBER	DESCRIPTION	INITIAL LICENSE FEE	MONTHLY LICENSE FEE	-----MONTHLY RENTAL PRICES-----			
				1 YEAR	2 YEAR	3 YEAR	5 YEAR
<u>OPTIONAL ALLIANCE SOFTWARE (continued)</u>							
AL-NOTES	Notebook (195-2236-3)	\$ 1,000	\$ 10	\$ 47	\$ 46	\$ 44	40
AL-VOICE	Voice Documents (Requires audio workstation) Dictation Transcription (195-2237-3)	2,000	20	94	92	88	80
AL-CPH	Alliance CP/M (195-2238-3)	1,000	10	47	46	44	40
AL-BASIC	Alliance Basic (195-2239-3)	3,000	30	141	138	132	120
AL-3271E	3271 Emulation Software (Requires OIS-TC) (195-2243-3)	2,500	25	118	115	110	100
AL-BATCH	2780/3780/WPS Emulation Software (Requires OIS-TC for Alliance Systems or TC-SC/AC-2T for 7500T Systems)(195-2244-3)	1,500	15	71	69	66	60
AL-TTE	Software package providing asynchronous communication facilities on Alliance and Teletypewriter emulation. (Requires OIS-TC for Alliance Systems or TC-SC/AC-2T for 7500T Systems (195-2454-3)	1,500	15	71	69	66	60
AL-LOGON	Alliance Security Logon II (195-2514-3)	500	5	24	23	22	20
AL-SNA	SNA 3274 Emulation Software (Requires OIS-TC)(195-2620-3)	2,000	20	108	100	86	80
HPALL	Level 3 Distribution Point Software for Alliance 250 systems. Mailway requires TC-SC-2, TC-AC-2 or TCP. (195-2516-3)	600	N/A	N/A	N/A	N/A	N/A
AL-OFFICE	WANG OFFICE on the Alliance	1,000	9	55	51	44	40
<u>OPTIONAL ALLIANCE SOFTWARE WITHOUT QUANTITY DISCOUNTS</u>							
AL-MULTI	Multiplan Electronic Spread Sheet for Alliance 250, 7550T Quantity discounts not offered on this model (195-2341-3)	\$ 600	N/A	N/A	N/A	N/A	N/A
AL-CHARTER	Alliance Graphics Software Quantity discounts not offered on this model (195-2515-3)	2,000	20	94	92	88	80

NOTE: All orders for add-ons and upgrade equipment MUST include the work order numbers and serial numbers of the system components involved.

MODEL NUMBER	DESCRIPTION	INITIAL LICENSE FEE	MONTHLY LICENSE FEE	-----MONTHLY RENTAL PRICES-----			
				1 YEAR	2 YEAR	3 YEAR	5 YEAR

ALLIANCE EDITOR PACKAGE

AL-WP-PLUS	Optional Advanced Word Processing Package for Alliance Systems (195-2761-3)	\$ 2,000	\$ 17	\$ 110	\$ 102	\$ 88	\$ 80
------------	---	----------	-------	--------	--------	-------	-------

ALLIANCE NETWORKING

ALI-WSNT-MS	Alliance Multipoint Secondary Transport	\$ 1,000	\$ 10	\$ 55	\$ 51	\$ 44	\$ 40
ALI-WSNT-PP	Alliance Point-Point Transport	1,500	15	83	77	66	60
ALI-WSNT-X25	Alliance X.25 Transport	1,500	15	83	77	66	60
ALI-WSNT-WB	Alliance WangBand Transport	N/A	N/A	N/A	N/A	N/A	N/A
ALI-WSNS-LGN	Alliance VS Terminal Emulation Service	400	4	22	21	18	16
ALI-WSNS-FT	Alliance File Transfer Service	600	6	33	31	27	24

QUANTITY DISCOUNTS FOR SOFTWARE

Discounts are allowed for quantity purchases (sales only; no rentals except as noted on exception basis\*). Orders must be submitted on a single purchase order, delivery may be to multiple delivery points, but must be within six (6) months of initial order. Quantity discounts are applied per model number not on an aggregate basis except as noted on an exception basis\*. Products for which Wang publishes multi-unit discounts shall receive the higher of the applicable published multi-unit quantity discount, or the Annual Volume Agreement discount, but not both.

REFER TO THE SOFTWARE QUANTITY DISCOUNT SCHEDULE (PAGE 1-6). ALL SOFTWARE PACKAGES ARE ELIGIBLE UNLESS SPECIFICALLY INDICATED.

MODEL NUMBER	DESCRIPTION	PURCHASE PRICE	MONTHLY MAINTENANCE	-----MONTHLY RENTAL PRICES-----			
				1 YEAR	2 YEAR	3 YEAR	5 YEAR

DATA COMMUNICATIONS OPTIONS

The following devices represent complete data communications packages (DCC board, connector and software) contained in an external box. Cannot be upgraded to use DIS-TC, DIS-TC1 Autodial or software other than that shipped with these products.

TC-3	System 5 Telecommunications: TTY/2741, 2780, 3780, WPS and Mailway <sup>®</sup>	\$ 1,200	\$ 19	\$ 57	\$ 56	\$ 53	\$ 48
------	---	----------	-------	-------	-------	-------	-------

MAILWAY<sup>®</sup> support requires additional components. Please refer to the MAILWAY<sup>®</sup> Price List section of the Pricing Manual. Customers must supply the modems for all communications workstations and controllers.

NOTE: All orders for add-ons and upgrade equipment MUST include the work order numbers and serial numbers of the system components involved.

MODEL NUMBER	DESCRIPTION	PURCHASE PRICE	MONTHLY MAINTENANCE	-----MONTHLY RENTAL PRICES-----			
				1 YEAR	2 YEAR	3 YEAR	5 YEAR

DATA COMMUNICATIONS COMPONENTS

Please note that while the DCC hardware could support all of the physical connection types if given the appropriate connectors, the communications software may not. Consult the software matrix for compatibility issues. For DCC hardware going into an OIS 40/50/60, add a -9 to the appropriate model number (i.e. CN-RS232-9 connector for OIS 40/50/60).

CN-RS232	Connector for RS-232 or CCITT V.24 modem support for OIS-TC options	\$ 150	N/A	N/A	N/A	N/A	N/A
CN-RS366	Connector for RS-366 or CCITT V.25 auto dial support for OIS-TC options	150	N/A	N/A	N/A	N/A	N/A
CN-X21	Connector for X.21 support on OIS	150	N/A	N/A	N/A	N/A	N/A

The Front panel assembly provides the appropriate front panel for the chassis specified. This assembly varies between the OIS 140/145A/Alliance and the 105/115/125A/130A model lines, as well as between slot one or slot two in the models that support more than one internal controller. One of these options **MUST** be selected for each DCC purchased.

OIS-FP1	Front panel for OIS 140/145A and Alliance - 1st board (slot) (Requires OIS-TC or OIS-TC1)	150	N/A	N/A	N/A	N/A	N/A
OIS-FP2	Front panel for OIS 140/145A and Alliance - 2nd board (slot) (Requires OIS-TC or OIS-TC1)	150	N/A	N/A	N/A	N/A	N/A
OIS-FP105	Front panel for 105/115/125A/130A - one board supported (Requires OIS-TC or OIS-TC1)	150	N/A	N/A	N/A	N/A	N/A
OIS-FPTCP	Front panel for use with each DCC in the OIS-6554. Includes coax.	150	N/A	N/A	N/A	N/A	N/A
OIS-FP50	Front panel for OIS 40/50/60 - one board supported (Required for OIS-TC or OIS-TC1)	150	N/A	N/A	N/A	N/A	N/A

This provides the 6554 (TCP) external chassis and power supply. While the OIS and Alliance systems can support a limited number of processors internally, the external chassis can support up to 4 processors. For each communications port required, one Data Communications Controller, one connector option, and the front panel assembly need to be ordered. NOTE: For each communications port installed on the external chassis, there must be a port available for connection at the master.

OIS-6554	External Chassis (TCP), supports up to 4 DCCs (OIS-TC or OIS-TC1)	2,000	50	94	92	88	80
----------	---	-------	----	----	----	----	----

NOTE: All orders for add-ons and upgrade equipment **MUST** include the work order numbers and serial numbers of the system components involved.



MODEL NUMBER	DESCRIPTION	PURCHASE PRICE	MONTHLY MAINTENANCE	-----MONTHLY RENTAL PRICES-----			
				1 YEAR	2 YEAR	3 YEAR	5 YEAR

DATA COMMUNICATIONS COMPONENTS (continued)

TCP-RS232	Connector for RS-232 or CCITTV.24 modem support for external chassis	\$ 200	N/A	N/A	N/A	N/A	N/A
TCP-RS366	Connector for RS366 or CCITTV.25 auto dial support for external chassis	200	N/A	N/A	N/A	N/A	N/A
TCP-X21	Connector for X.21 support for external chassis	200	N/A	N/A	N/A	N/A	N/A
<u>NULL MODEMS</u>							
NM-1	Asynchronous RS232 Null Modem for TTY, 2741 and OCR-1 (for all WP/OIS use)	\$ 100	N/A	N/A	N/A	N/A	N/A
NM-2	Synchronous RS232 Null Modem for System 5 only	50	N/A	N/A	N/A	N/A	N/A
NM-3	Synchronous RS232 Null Modem for all products except System 5	50	N/A	N/A	N/A	N/A	N/A

NOTE: The Wang PC may used as and OIS or Alliance workstation, please refer to the Wang PC section of the Pricing Manual for information on ordering. A minimum of PC-002 and PC-PH041 are required.

WORKSTATIONS (All Include Horizontal Scroll)

OIS and Alliance Workstations

5536-4	64K CRT/keyboard workstation	\$ 4,200	\$ 27	\$ 231	\$ 184	\$ 176	160
--------	------------------------------	----------	-------	--------	--------	--------	-----

Archiving Workstations with 8 Inch Media

AWS-4	64K Archiving workstation with standard keyboard	\$ 6,500	\$ 47	\$ 292	\$ 286	\$ 273	248
AWS-C4	64K Archiving workstation with standard keyboard for DP/WP/RWN	6,500	47	292	286	273	248

Remote WangNet WP/DP Workstations

Remote WangNet applications for OIS 115-2,3,4, 130A, 140, 145A only. (5300/VS-IIS64 requires 5300KBD/IIS-STD and 5300 Display.)

5556C	64K CRT/keyboard workstation for WP/DP application within Remote WangNet	\$ 4,200	\$ 27	\$ 250	\$ 184	\$ 176	160
5300/VS-IIS64	64K Combined Workstation Electronics for WP/DP application	3,050	15	198	134	128	116

NOTE: All orders for add-ons and upgrade equipment MUST include the work order numbers and serial numbers of the system components involved.

MODEL NUMBER	DESCRIPTION	PURCHASE PRICE	MONTHLY MAINTENANCE	-----MONTHLY RENTAL PRICES-----			
				1 YEAR	2 YEAR	3 YEAR	5 YEAR
Archiving Workstations with 8 inch Media							
Include numeric keypad							
5740-4	64K Ergonomic Archiving workstation with standard keyboard	\$ 6,825	\$ 56	\$ 358	\$ 332	\$ 306	280
<b>4200 SERIES WORKSTATIONS</b>							
4200 Series Workstations consist of three components. The Display Monitor includes the CRT only. The Electronics Package consists of all the workstation boards, power supply and packaging. The Keyboard includes a specific Wang keyboard, all are standard with numeric keypad. 4200 Series Workstations can also be upgraded to a Wang Professional Computer.							
Discounts are allowed for quantity purchases (sales only; no rentals except as noted on exception basis*). Orders must be submitted on a single purchase order, delivery may be to multiple delivery points, but must be within six (6) months of initial order. Quantity discounts are applied per model number not on an aggregate basis except as noted on an exception basis*. Products for which Wang publishes multi-unit discounts shall receive the higher of the applicable published multi-unit quantity discount, or the Annual Volume Agreement discount, but <u>not both</u> .							
* 4200 Series Workstation that are eligible for quantity discounts (model numbers 4205, 4210, and 4230) can also be aggregated to qualify for discounts. The 4250 has its own discount schedule and cannot be aggregated.							
4230-0A	64K OIS/Alliance Workstation, CRT, Keyboard, Base						
	Quantities of 1 to 9 (-)	\$ 3,800	\$ 24	\$ 228	\$ 209	\$ 168	152
	Quantities of 10 to 29 (5%)	3,610	24	228	209	168	152
	Quantities of 30 to 49 (10%)	3,420	24	228	209	168	152
	Quantities of 50 and up (15%)	3,230	24	228	209	168	152
4230TC	64K Telecommunications Workstation, CRT, Keyboard, Base						
	Quantities of 1 to 9	4,400	32	264	242	194	176
	Quantities of 10 to 29	4,180	32	264	242	194	176
	Quantities of 30 to 49	3,960	32	264	242	194	176
	Quantities of 50 and up	3,740	32	264	242	194	176
4250-0A*	4250-0A Workstation						
	Quantities of 1 to 19 (-)	5,265	29	343	290	253	N/A
	Quantities of 20 to 49 (12%)	4,635	29	343	290	253	N/A
	Quantities of 50 to 149 (16%)	4,425	29	343	290	253	N/A
	Quantities of 150 to 249 (20%)	4,215	29	343	290	253	N/A
4200-AC001	4200 Series Monitor Arm Includes required 8 foot cable						
	Quantities of 1 to 9	225	N/A	14	13	10	9
	Quantities of 10 to 29	215	N/A	14	13	10	9
	Quantities of 30 to 49	205	N/A	14	13	10	9
	Quantities of 50 and up	195	N/A	14	13	10	9

\*4250 has unique discounts.

NOTE: All orders for add-ons and upgrade equipment MUST include the work order numbers and serial numbers of the system components involved.

MODEL  
NUMBER

DESCRIPTION

PURCHASE  
PRICEMONTHLY  
MAINTENANCE-----MONTHLY RENTAL PRICES-----  
1 YEAR 2 YEAR 3 YEAR 5 YEAR5300 SERIES ERGONOMIC WORKSTATIONS

5300 Series Workstations consist of three components. The Display Monitor includes the CRT only. The Electronics Package consists of all the workstation boards, power supply and packaging. The Keyboard includes a specific Wang keyboard, all are standard with numeric keypad.

DISPLAY MONITOR

MODEL NUMBER	DESCRIPTION	PURCHASE PRICE	MONTHLY MAINTENANCE	1 YEAR	2 YEAR	3 YEAR	5 YEAR
5310	Green Display Audio (Alliance only)	\$ 1,150	\$ 20	\$ 72	\$ 51	\$ 49	\$ 44
5320	Green Display	1,080	20	66	46	44	40
5330	Black/White Audio (Alliance only)	1,250	20	77	56	53	48
5340	Black on White Display	1,150	20	72	51	49	44

ELECTRONICS PACKAGESWP/OIS/ALLIANCE

5300/AL-64	Alliance workstation electronics, 64K	\$ 3,050	15	\$ 198	\$ 134	\$ 128	\$ 116
5300W	Alliance Workstation electronics, 64K, with WangNet interface	3,650	20	198	161	154	140

OIS/ALLIANCE ONLY

5300/PS	Workstation electronics 64K proportional space	\$ 3,800	\$ 19	\$ 215	\$ 166	\$ 159	\$ 144
5300W/PS	Proportional Space workstation electronics with WangNet interface (OIS/Alliance only)	4,400	24	212	194	185	168

ALLIANCE ONLY

5300/AL-AUDIO	Alliance workstation electronics 64K audio	\$ 3,800	\$ 33	\$ 248	\$ 166	\$ 159	\$ 144
5300W/AUD	Alliance Workstation electronics, 64K audio, with WangNet interface	4,400	37	240	194	185	168
5300/AUDIO-PS	Workstation electronics 64K Audio/Proportional space	4,300	36	264	189	181	164
5300W/AUD-PS	Alliance workstation electronics, 64K audio, proportional space with WangNet interface	4,900	41	254	217	207	188

NOTE: All orders for add-ons and upgrade equipment MUST include the work order numbers and serial numbers of the system components involved.

WP/OIS/ 1 - 18

COMPANY CONFIDENTIAL  
REPLACES: 02/01/84  
EFFECTIVE: 05/01/84

WP/OIS

MODEL NUMBER	DESCRIPTION	PURCHASE PRICE	MONTHLY MAINTENANCE	-----MONTHLY RENTAL PRICES-----			
				1 YEAR	2 YEAR	3 YEAR	5 YEAR
<u>KEYBOARD</u>							
ALL OIS KEYBOARDS ALREADY HAVE A NUMERIC KEYPAD							
UNI/KBD-US	United States Low Profile Serial Keyboard	\$ 525	N/A	32	30	26	24
5300KBD/IIS-STD	Combined Keyboard for WP/DF application(For WangNet Ergos)	525	N/A	28	26	24	22
<u>OPTIONS</u>							
5300/TC	TC Option (WPS/OIS only)	\$ 800	\$ 25	\$ 83	\$ 35	\$ 33	30
HEADSET	Headset for Audio Transcription (Audio only)	20	N/A	N/A	N/A	N/A	N/A
FOOTPEDAL	Footpedal for Audio Transcription (Audio only)	50	N/A	N/A	N/A	N/A	N/A
TELSET	Auxiliary Telephone Set (AUDIO ONLY) Required for use in situations where the customer telephone instrument cannot be used. A TELSET MUST accompany all Int'l Audio Workstation orders.	100	N/A	N/A	N/A	N/A	N/A

NOTE: TC Workstations are not supported on Alliance.

6300 SERIES GRAPHICS WORKSTATIONS

6300 Series Workstations consist of three components. The Display Monitor includes the CRT only. The Electronics Package consists of all the workstation boards, power supply and packaging. The Keyboard includes a specific Wang Keyboard, all are standard with numeric keypad. The 6300 Graphics Workstation can be attached to an OIS, Alliance, VS or VS/IIS system. The printer for Graphics is the 5577 high-density Matrix Printer.

<u>Display Monitor</u>							
6340	Black and White Graphic Display	\$ 1,350	\$ 20	\$ 90	\$ 63	\$ 60	54
<u>Electronics Package</u>							
6300/OIS-64	Electronics for OIS Graphics with 64K	\$ 3,900	\$ 20	\$ 258	\$ 180	\$ 172	156
<u>Keyboard</u>							
UNI/KBD-US	United States Low Profile Serial Keyboard	\$ 525	N/A	\$ 32	\$ 30	\$ 26	24

NOTE: All orders for add-ons and upgrade equipment MUST include the work order numbers and serial numbers of the system components involved.

MODEL  
NUMBER

DESCRIPTION

PURCHASE  
PRICE

MONTHLY  
MAINTENANCE

-----MONTHLY RENTAL PRICES-----  
1 YEAR 2 YEAR 3 YEAR 5 YEAR

COMMUNICATIONS WORKSTATIONS

All Communications Workstations include horizontal scroll and support TTY/2741, 2780, and 3780 emulations. WPS and Mailway<sup>®</sup> protocols are also supported. MAILWAY<sup>®</sup> support requires additional components. Please refer to the MAILWAY<sup>®</sup> Price List section of the Pricing Manual. Customers must supply the modems for all communications workstations and controllers.

NOTE: TC workstations are for WPS and OIS only not supported on Alliance.

TC-5536-4	64K CRT/keyboard workstation	\$ 5,000	\$ 47	\$ 301	\$ 219	\$ 209	190
-----------	------------------------------	----------	-------	--------	--------	--------	-----

Archiving Workstations with 8 inch Media

TC-AWS-4	64K Archiving workstation with standard keyboard	\$ 7,300	\$ 66	\$ 362	\$ 320	\$ 306	278
----------	--	----------	-------	--------	--------	--------	-----

TC-AWS-C4	64K Archiving workstation with standard keyboard for DP/WP/COMH/RWN	7,300	66	362	320	306	278
-----------	---	-------	----	-----	-----	-----	-----

Remote WangNet WP/DP Terminals

TC-5556C	64K CRT/keyboard workstation for WP/DP application within Remote WangNet (OIS 115-2,3,4, 130A, 140, 145A only)	\$ 5,000	\$ 47	\$ 301	\$ 219	\$ 209	190
----------	--	----------	-------	--------	--------	--------	-----

Archiving Workstations with 8 inch Media

Include numeric keypad

TC-5740-4	64K Ergonomic archiving workstation with standard keyboard	\$ 7,625	\$ 81	\$ 440	\$ 334	\$ 319	290
-----------	--	----------	-------	--------	--------	--------	-----

WORKSTATION OPTIONS

NK-1	Numeric Keypad for standard Workstations (5506-n, 5536-n, TC-5536-n, AWS-n, and TC-AWS-n)	\$ 200	N/A	N/A	N/A	N/A	N/A
------	---	--------	-----	-----	-----	-----	-----

PRINTERS

WPS 20, 25-3, 30 AND ALL OIS

DM/OS-55	55 CPS, Bidirectional Daisy Wheel Printer (OIS, Alliance)	5,000	43	295	255	220	200
----------	---	-------	----	-----	-----	-----	-----

6581W-1	35 CPS Daisy Wheel Printer	\$ 6,000	\$ 49	\$ 282	\$ 255	\$ 220	200
---------	----------------------------	----------	-------	--------	--------	--------	-----

6581WC-1	35 CPS Wide Carriage Daisy Wheel Printer	7,000	49	329	322	308	280
----------	--	-------	----	-----	-----	-----	-----

NOTE: All orders for add-ons and upgrade equipment MUST include the work order numbers and serial numbers of the system components involved.

WP/OIS/ 1 - 20

COMPANY CONFIDENTIAL  
REPLACES: 02/01/84  
EFFECTIVE: 05/01/84



MODEL NUMBER	DESCRIPTION	PURCHASE PRICE	MONTHLY MAINTENANCE	MONTHLY RENTAL PRICES			
				1 YEAR	2 YEAR	3 YEAR	5 YEAR
PRINTERS (continued)							
WPS 20, 25-3, 30 AND ALL OIS							
5533	120 CPS Bidirectional Matrix Printer 12.2 Pitch ONLY, 158 Columns OIS ONLY	3,500	46	165	161	154	140
5535	180/222 CPS Bidirectional Matrix Printer. 10 Pitch ONLY, 132 Columns ONLY	\$ 4,500	\$ 64	\$ 212	\$ 207	\$ 198	\$ 180
5574	Medium Speed Band Printer with 1 Utility C Print Band. See General Information Section of VS Price List for Print Band Alternatives.	13,250	145	623	610	583	530
OIS							
5581MD	25 CPS Twinhead Daisy Printer (OIS only)	\$ 9,750	104	\$ 459	\$ 449	\$ 429	\$ 390
DW/OS-20	20 CPS, Bidirectional Daisy Wheel Printer (OIS, Alliance)	2,695	37	127	124	119	108
5577	192/40 CPS High Density Matrix Printer (OIS 100)	5,975	55	281	275	263	239
LPS-12	Laser Printing System - 12 OIS 100 Systems Monthly per page charges after 5,000 pages 1.5 cents purchase, 3.2 cents rental	20,000	275	920	820	760	N/A
LIS-12	Laser Imaging Systems for Wang OIS 100 Systems Monthly per page charges after 5,000 pages 1.5 cents purchase, 3.2 cents rental	26,000	300	1,196	1,066	988	N/A
ALLIANCE, OIS							
DW/OS-55	55 CPS, Bidirectional Daisy Wheel Printer (OIS, Alliance)	5,000	43	295	255	220	200
6581W-1	35 CPS Daisy Wheel Printer	\$ 6,000	\$ 49	\$ 282	\$ 255	\$ 220	\$ 200
6581WC-1	35 CPS Wide Carriage Daisy Wheel Printer	7,000	49	329	322	308	280
5533-1	120 CPS Bidirectional Matrix Printer. 12.2 Pitch ONLY, 158 Columns OIS ONLY	3,500	46	165	161	154	140

NOTE: All orders for add-ons and upgrade equipment MUST include the work order numbers and serial numbers of the system components involved.

MODEL  
NUMBER

DESCRIPTION

PURCHASE  
PRICEMONTHLY  
MAINTENANCE-----MONTHLY RENTAL PRICES-----  
1 YEAR 2 YEAR 3 YEAR 5 YEARPRINTERS (continued)ALLIANCE, OIS

5535-1	180 CPS Bidirectional Matrix Printer. 10 Pitch ONLY, 132 Columns ONLY	\$ 4,500	\$ 64	\$ 212	\$ 207	\$ 198	180
5577A	192/40 CPS High Density Matrix Printer for Alliance Systems only	5,975	55	281	275	263	239
5577-9	192/40 CPS High-Density Matrix Printer (OIS 40, 50, 60)	5,975	55	281	275	263	239
5581MD-1	Twinhead Daisy Wheel Printer	9,750	104	459	449	429	390
LPS-12A	Laser Printing System - 12 for Alliance 250 Systems Monthly per page charges after 5,000 pages 1.5 cents purchase, 3.2 cents rental	20,000	275	920	820	760	N/A
LIS-12A	Laser Imaging System for Wang Alliance 250 Systems Monthly per page charges after 5,000 pages 1.5 cents purchase, 3.2 cents rental	26,000	300	1,196	1,066	988	N/A
LPS-12-9	Laser Printing System - 12 for Wang OIS 40/50/60 Systems Monthly per page charges after 5,000 pages 1.5 cents purchase 3.2 cents rental	20,000	275	920	820	760	N/A
LIS-12-9	Laser Imaging System for Wang OIS 40/50/60 Systems Monthly per page charges after 5,000 pages 1.5 cents purchase, 3.2 cents rental	26,000	300	1,196	1,066	988	N/A

PRINTER OPTIONSPRINTER MULTIPLEXERS

5541M	Shared Printer Interface, 5541W or 5541MC only (System 5 only)	\$ 500	\$ 8	\$ 28	\$ 26	\$ 22	20
5541DM	Shared Printer Interface, 5541D only (System 5 only)	500	8	28	26	22	20

NOTE: All orders for add-ons and upgrade equipment MUST include the work order numbers and serial numbers of the system components involved.

WP/OIS/ 1 - 22

COMPANY CONFIDENTIAL  
REPLACES: 02/01/84  
EFFECTIVE: 05/01/84

WP/OIS

MODEL NUMBER	DESCRIPTION	PURCHASE PRICE	MONTHLY MAINTENANCE	-----MONTHLY RENTAL PRICES-----			
				1 YEAR	2 YEAR	3 YEAR	5 YEAR
SINGLE SHEET FEEDER							
SSF-20	Single Bin Sheet Feeder for OIS PTR20 and PC-PM012	\$ 500	\$ 10	N/A	N/A	N/A	N/A
DUAL SHEET FEEDER							
DSF-55	Dual Sheet Feeder for DW/OS-55 8 1/2" X 11" paper size	\$ 2,000	\$ 21	\$ 110	\$ 102	\$ 88	\$ 80
TWIN SHEET FEEDERS							
The following Twin Sheet Feeders use paper sizes: 8 1/2" x 11" to 8 1/2" x 14" or 21.59 cm x 27.94 cm to 21.59 cm x 35.56 cm							
TSF-01	Twin Sheet Feeder for 5541W	\$ 2,000	\$ 21	\$ 110	\$ 102	\$ 88	\$ 80
TSF-05	Twin Sheet Feeder for 5541WC	2,000	21	110	102	88	80
TSF-31	Twin Sheet Feeder for 6581W	2,000	21	110	102	88	80
TSF-41	Twin Sheet Feeder for 6581WC	2,000	21	110	102	88	80
TSF-51	Twin Sheet Feeder for DW/OS-20 DW/22-20	2,000	21	110	102	88	80
TSF-61	Twin Sheet Feeder for 5577	2,000	21	110	102	88	80
The following Twin Sheet Feeders for International use paper sizes: 8 1/4" x 11 3/4" to 8 1/4" x 14" or 20.95 cm x 29.70 cm to 20.95 cm x 35.56 cm							
TSF-03	Twin Sheet Feeder for 5541W	\$ 2,000	\$ 21	\$ 110	\$ 102	\$ 88	\$ 80
TSF-06	Twin Sheet Feeder for 5541WC	2,000	21	110	102	88	80
TSF-33	Twin Sheet Feeder for 6581W	2,000	21	110	102	88	80
TSF-43	Twin Sheet Feeder for 6581WC	2,000	21	110	102	88	80
TSF-53	Twin Sheet Feeder for DW/OS-20 DW/22-20	2,000	21	110	102	88	80
TSF-63	Twin Sheet Feeder for 5577	2,000	21	110	102	88	80

NOTE: All orders for add-ons and upgrade equipment MUST include the work order numbers and serial numbers of the system components involved.



MODEL NUMBER	DESCRIPTION	PURCHASE PRICE	MONTHLY MAINTENANCE	-----MONTHLY RENTAL PRICES-----			
				1 YEAR	2 YEAR	3 YEAR	5 YEAR
<b>ENVELOPE FEEDERS</b>							
EF-1	Envelope Feeder for 6581W 115 VAC 60HZ (U.S. sized business envelopes; (#7 3/4, 9, 10)	\$ 2,000	\$ 33	\$ 110	\$ 102	\$ 88	\$ 80
EF-21	Envelope Feeder for DW-20 Printer. 115 VAC 60hz (U.S. sized business envelopes; #7 3/4, 9, 10)	2,000	33	110	102	88	80
EF-2	Envelope Feeder for 6581W 220 VAC 50hz (U.S. sized business envelopes; (#7 3/4, 9, 10)	2,000	33	110	102	88	80
EF-22	Envelope Feeder for DW-20 Printer. 220 VAC 50hz (U.S. sized business envelopes; #7 3/4, 9, 10)	2,000	33	110	102	88	80
EF-3	Envelope Feeder for 6581W 220 VAC 50z (Int. sized business envelopes; min. 98.4 x 190.5mm max. 108 x 222.4mm)	2,000	33	110	102	88	80
EF-23	Envelope Feeder for DW-20 Printer 220 VAC 50hz (Int'l sized business envelopes; min. 98.4 x 190.5 mm max. 108 x 222.4 mm)	2,000	33	110	102	88	80
<b>FORMS TRACTORS</b>							
FT-1	Mono-Directional Forms Tractor for 5577	\$ 250	N/A	N/A	N/A	N/A	N/A
FT-2	Mono-Directional Forms Tractor for DW-20	250	N/A	N/A	N/A	N/A	N/A
BFT-1	Bidirectional Forms Tractor for 2281W, 5541W, 5577, 6581W and DW/22-20	300	N/A	N/A	N/A	N/A	N/A

NOTE: All orders for add-ons and upgrade equipment MUST include the work order numbers and serial numbers of the system components involved.





MODEL NUMBER	DESCRIPTION	PURCHASE PRICE	MONTHLY MAINTENANCE	-----MONTHLY RENTAL PRICES-----			
				1 YEAR	2 YEAR	3 YEAR	5 YEAR
FORMS TRACTORS (continued)							
BFT-2	Bidirectional Forms Tractor for 2281MC, 5541MC and 6581MC	300	N/A	N/A	N/A	N/A	N/A
BFT-3	Bidirectional Forms Tractor for 5581MD (OIS ONLY)	300	N/A	N/A	N/A	N/A	N/A
BFT-20	Bidirectional Forms Tractor for OIS-PTR20 and PC-PH01Z	275	N/A	N/A	N/A	N/A	N/A
BFT-55	Bidirectional forms tractor for DM/OS-55 printer	\$ 300	N/A	N/A	N/A	N/A	N/A

COMPANY CONFIDENTIAL  
 WANG

NOTE: All orders for add-ons and upgrade equipment MUST include the work order numbers and serial numbers of the system components involved.



MODEL  
NUMBER

DESCRIPTION

PURCHASE  
PRICE

MONTHLY  
MAINTENANCE

-----MONTHLY RENTAL PRICES-----  
1 YEAR 2 YEAR 3 YEAR 5 YEAR

NOTE: The customer must sign the appropriate Wang licensing agreement before any order can be booked for model numbers WITA or WPS-CS.

WILS™ - WANG INTERACTIVE LEARNING SYSTEM

WILS orders that include any Wang hardware other than Telecommunications Cables must be submitted to Order Processing. Orders that include only WILS items (the WILS Programs, the Telecommunications Cables and/or the Sony Videodisc Player) must be submitted to the Supplies Division. Orders for component parts of the WILS Programs must also be submitted to the Supplies Division.

WILS WORD PROCESSING PROGRAM

WILS-01S	Wang Interactive Learning System™ for OIS (200-1041) Purchase price includes software license fee 5 Videodiscs 7 OIS Software Diskettes (8" media) 7 OIS Software Diskettes (5 1/4" media) 15 Standard Numeric Keypad Replacement Keys 9 Numeric Keypad Universal Replacement Keys 1 Keypad Replacement Tool 1 Standard Numeric Keypad Cover 1 Universal Numeric Keypad Cover 1 Word Processing Learner's Guide 1 Word Processing Program Administrator's Guide	\$ 5,000	N/A	N/A	N/A	N/A	N/A
----------	--	----------	-----	-----	-----	-----	-----

PARTS

VIDEODISCS

725-2795	WILS™ WP Disc 1	1,000	N/A	N/A	N/A	N/A	N/A
725-2796	WILS™ WP Disc 2	1,000	N/A	N/A	N/A	N/A	N/A
725-2797	WILS™ WP Disc 3	1,000	N/A	N/A	N/A	N/A	N/A
725-2798	WILS™ WP Disc 4	1,000	N/A	N/A	N/A	N/A	N/A
725-2799	WILS™ WP Disc 5	1,000	N/A	N/A	N/A	N/A	N/A

NOTE: All orders for add-ons and upgrade equipment MUST include the work order numbers and serial numbers of the system components involved.

MODEL NUMBER	DESCRIPTION	INITIAL LICENSE FEE	MONTHLY LICENSE FEE	-----MONTHLY RENTAL PRICES-----			
				1 YEAR	2 YEAR	3 YEAR	5 YEAR
<u>WILS WORD PROCESSING PROGRAM (continued)</u>							
<u>SOFTWARE DISKETTES</u>							
195-2553-3	WILS WP Software for OIS 100 (7 Diskettes)	\$ 500	N/A	N/A	N/A	N/A	N/A
WILS-WP-OIS-SW9	WILS WP Software for OIS 50/60 (7 Diskettes) (P/N 195-2553-9)	500	N/A	N/A	N/A	N/A	N/A
NUMBER	DESCRIPTION	PURCHASE PRICE	MONTHLY MAINTENANCE	-----MONTHLY RENTAL PRICES-----			
				1 YEAR	2 YEAR	3 YEAR	5 YEAR
<u>HP GUIDES</u>							
700-8400	WILS™ WP Learner's Guide	50	N/A	N/A	N/A	N/A	N/A
700-8401	WILS™ WP Program Administrator's Guide	25	N/A	N/A	N/A	N/A	N/A
<u>WILS GLOSSARY PROGRAM</u>							
WILS-GL-PROGRAM	Wang Interactive Learning System™ Glossary Program (P/N 200-1061) Purchase price includes software license fee 3 Videodiscs 5 DIS Software Diskettes (8" media) 5 DIS Software Diskettes (5 1/4" media) 4 VS Software Diskettes (8" media) 15 Standard Numeric Keypad Replacement Keys 9 Numeric Keypad Universal Replacement Keys 1 Keycap Replacement Tool 1 Standard Numeric Keypad Cover 1 Universal Numeric Keypad Cover 1 Glossary Program Learner's Guide 1 WILS™ Administrator's Guide	\$ 2,000	N/A	N/A	N/A	N/A	N/A

NOTE: All orders for add-ons and upgrade equipment MUST include the work order numbers and serial numbers of the system components involved.

MODEL NUMBER	DESCRIPTION	PURCHASE PRICE	MONTHLY MAINTENANCE	-----MONTHLY RENTAL PRICES-----			
				1 YEAR	2 YEAR	3 YEAR	5 YEAR

WILS GLOSSARY PROGRAM (continued)

PARTS

VIDEODISCS

WILS-GL-DISC5	WILS™ Glossary Videodiscs (P/N 200-1062)	\$ 2,100	N/A	N/A	N/A	N/A	N/A
WILS-GL-DISC1	WILS™ Glossary Videodisc 1 (P/N 725-2856)	700	N/A	N/A	N/A	N/A	N/A
WILS-GL-DISC2	WILS™ Glossary Videodisc 2 (P/N 725-2857)	700	N/A	N/A	N/A	N/A	N/A
WILS-GL-DISC3	WILS™ Glossary Videodisc 3 (P/N 725-2858)	700	N/A	N/A	N/A	N/A	N/A

MODEL NUMBER	DESCRIPTION	INITIAL LICENSE FEE	MONTHLY LICENSE FEE	-----MONTHLY RENTAL PRICES-----			
				1 YEAR	2 YEAR	3 YEAR	5 YEAR

SOFTWARE DISKETTES

WILS-GL-OIS-SW	Glossary Software-OIS 8" (P/N 195-2903-3)	200	N/A	N/A	N/A	N/A	N/A
WILS-GL-OIS-SW9	Glossary Software-OIS 5 1/4" (P/N 195-2903-9)	200	N/A	N/A	N/A	N/A	N/A
WILS-GL-VS-SW	Glossary Software-VS/IIS 8" (P/N 195-2904-3)	200	N/A	N/A	N/A	N/A	N/A

MODEL NUMBER	DESCRIPTION	PURCHASE PRICE	MONTHLY MAINTENANCE	-----MONTHLY RENTAL PRICES-----			
				1 YEAR	2 YEAR	3 YEAR	5 YEAR

WP GUIDES

WILS-GL-LEARNER	WILS™ Glossary Program Learner's Guide (P/N 700-8703)	50	N/A	N/A	N/A	N/A	N/A
WILS-ADMIN	WILS™ Administrator's Guide (P/N 700-8401A)	25	N/A	N/A	N/A	N/A	N/A

NOTE: All orders for add-ons and upgrade equipment MUST include the work order numbers and serial numbers of the system components involved.



MODEL NUMBER	DESCRIPTION	PURCHASE PRICE	MONTHLY MAINTENANCE	-----MONTHLY RENTAL PRICES-----			
				1 YEAR	2 YEAR	3 YEAR	5 YEAR
<u>COMPONENT PARTS FOR WILS WORD PROCESSING AND GLOSSARY PROGRAMS</u>							
<u>KEYCAPS/KEYPAD COVER</u>							
WILS-STOKEYS	WILS™ Keycaps for standard numeric keypad (P/N 200-4057-Q6)	\$ 15	N/A	N/A	N/A	N/A	N/A
WILS-UNIKEYS	WILS™ Keycaps for universal numeric keypad (P/N 200-4101-Q6)	15	N/A	N/A	N/A	N/A	N/A
WILS-PULLER	WILS™ Keycaps Replacement Tool (P/N 725-2806)	15	N/A	N/A	N/A	N/A	N/A
WILS-STDCOVER	WILS™ Standard Numeric Keypad Cover (P/N 449-0745)	10	N/A	N/A	N/A	N/A	N/A
WILS-UNICOVER	WILS™ Universal Numeric Keypad Cover (P/N 449-0846)	10	N/A	N/A	N/A	N/A	N/A
<u>SONY PLAYER</u>							
725-0141	SONY LDP1000A Video Disc Player	2,600	N/A	N/A	N/A	N/A	N/A

COMPANY CONFIDENTIAL  
 WANG

NOTE: All orders for add-ons and upgrade equipment MUST include the work order numbers and serial numbers of the system components involved.

WPS/OIS UPGRADES

INTRODUCTION

This upgrade price list consists of several major segments. It includes:

- Definitions of the terms used.
- General information regarding the use of the price list.
- Matrix charts to assist in the determination of the proper "upgrade job" to order.
- Prices for UJ model numbers.

DEFINITIONS:

Upgrades are model numbers beginning with UJ (for "Upgrade Job") which add functionality to an existing system. The general term "upgrade" is often used in practice in lieu of one of the following more specific terms.

"True" Upgrades are changes that may add hardware (including serialized equipment) but do not displace serialized equipment, such as a board swap. Most UJ model numbers beginning with an odd number in the leftmost digit, e.g., UJ-1000, are true upgrades. Prices for true upgrades do not include a credit for displaced equipment.

Exchanges are hardware changes that displace at least one piece of serialized equipment which becomes available for remarketing. Most UJ model numbers beginning with an even number in the leftmost digit, e.g., UJ-2000, are exchanges. Distributor prices for exchanges do not include any credit for the displaced equipment, and are priced at full hardware price for equivalent non-UJ model numbers. End user prices for exchanges, as suggested in the International List Price Book, do include a credit for the displaced equipment in the UJ price.

Trade-Ins are hardware changes similar to exchanges except that they are not specifically covered by any UJ model number. Since no UJ model number applies, Distributor must order the new equipment required. End user credit for the displaced (trade-in) equipment is recommended in the Trade-In policy section of the International List Price Book.

Field Upgrades are a type of true upgrade which can be accomplished by a customer engineer without the installation of any additional equipment. Accordingly these may not be ordered from Wang Laboratories, Inc. by a Distributor. End user prices for field upgrades are suggested in the International List Price Book.

Serialized Equipment is any system component marked with a serial number tag and including but not limited to:

- Master Units / CPUs
- Workstations
- Disk Drives
- Printers

NOTE: All orders for add-ons and upgrade equipment MUST include the work order numbers and serial numbers of the system components involved.

GENERAL INFORMATION

1. The sales representative must submit the appropriate upgrade job number whenever upgrading a system. There is a unique upgrade job number for each "upgrade" of master. "Upgrades" of workstations, communications, printers and other peripherals, if necessary, require separate, unique, upgrade job numbers.
2. All upgrade job numbers have been listed in this price list.
3. Submission of "upgrades" must be accompanied by the serial number of the pieces of serialized hardware affected (e.g., memory is being added to a workstation, the serial number of that workstation must be noted). Reference must be made to the purchase and work order numbers on which the equipment was originally ordered.
4. "Upgrade" charges apply to both purchased and rented equipment.
5. A customer who has purchased hardware pays the amount listed under the column "Purchase Single Charge." This includes both the "upgrade" charge and the difference, if any, in the list price of the items. Maintenance on the upgraded unit is also due.
6. A customer with rented hardware may opt to pay either the "Rental Single Charge" or the "Rental Monthly" payments for one (1) year. In either case, the incremental difference in the monthly rental rates is also due. If the "upgrade" is to a master, a new minimum rental period, the same as the initial rental period, will commence upon master upgrade completion. If the "upgrade" is to a workstation, communications, printer or other peripherals, its rental term will be made coterminous with the master.
7. Trade-ins are applicable to purchased hardware only. The following situations require a trade-in:
  - Movement from a WPS system (5 through 30) to an OIS system (105 through 145A).
  - Movement from a 5526 (three-board) workstation to a 5536-3 (48K) or 5536-4 (64K) two-board workstation.
  - Movement from a System 5 workstation to any workstation other than a 5536-1 (16K) for a WPS system.
  - Addition of communications to a 5526 (three-board) workstation.

NOTE: All orders for add-ons and upgrade equipment MUST include the work order numbers and serial numbers of the system components involved.



UPGRADE  
JOB #

DESCRIPTION

PURCHASE  
PRICE

-----R E N T A L-----  
SINGLE OR MONTHLY  
CHARGE CHARGE 1 YEAR

The purchase/rental charges listed include any applicable difference in prices. For purchase systems the incremental maintenance charge is also due.

WANGWRITER UPGRADES

Discounts are allowed for quantity purchases (sales only; no rentals except as noted on exception basis\*). Orders must be submitted on a single purchase order, delivery may be to multiple delivery points, but must be within six (6) months of initial order. Quantity discounts are applied per model number not on an aggregate basis except as noted on an exception basis\*. Products for which Wang publishes multi-unit discounts shall receive the higher of the applicable published multi-unit quantity discount, or the Annual Volume Agreement discount, but not both. Quantity discounts apply.

UJ-1163	From 5503A to 5503D	\$ 1,600	\$ 500	\$ 50
UJ-2105	From 5503A to 5504S	1,800	1,600	160
UJ-2106	From 5503A to 5504D	2,600	1,300	130
UJ-2107	From 5503D to 5504D	1,600	1,400	140
UJ-1162	From 5504S to 5504D	1,600	500	50
UJ-1255	From 5524S to 5524D	1,600	1,100	110

SHEET FEEDER UPGRADES

UJ-1194	Single Sheet Feeder support upgrade for Wangwriter 5503A/D	\$ 300	N/A	N/A
UJ-1253	Single Sheet Feeder support upgrade for Wangwriter 5504S/D	200	200	20

WANGWRITER FTC UPGRADE

UJ-1254	Add FTC/TC to 5504S/D and 5524S/D	\$ 1,000	\$ 250	\$ 25
---------	-----------------------------------	----------	--------	-------

NOTE: All orders for add-ons and upgrade equipment MUST include the work order numbers and serial numbers of the system components involved.



WPS UPGRADES/EXCHANGES

FROM/TO	25-3	30
25-1	UJ-1034	UJ-1035
25-2	UJ-1036	UJ-1037
25-3	N/A	UJ-1038

N/A = Not Available

COMPANY CONFIDENTIAL  
WANG

NOTE: All orders for add-ons and upgrade equipment MUST include the work order numbers and serial numbers of the system components involved.

UPGRADE  
JOB #

DESCRIPTION

PURCHASE  
PRICE

-----R E N T A L-----  
SINGLE OR MONTHLY  
CHARGE 1 YEAR

The purchase/rental charges listed include any applicable difference in prices. For purchase systems the incremental maintenance charge is also due.

WPS UPGRADES/EXCHANGES

NOTE: Math and Sort should be ordered, at no charge, when upgrading from a System 5-3.

UJ-1034	System 25-1 to 25-3 (Field Upgradable)	\$ 500	\$ 500	\$ 50
UJ-1035	System 25-1 to 30 (Field Upgradable)	1,500	500	50
UJ-1036	System 25-2 to 25-3 (Field Upgradable)	500	500	50
UJ-1037	System 25-2 to 30 (Field Upgradable)	1,000	500	50
UJ-1038	System 25-3 to 30 (Field Upgradable)	1,000	500	50

NOTE: All orders for add-ons and upgrade equipment MUST include the work order numbers and serial numbers of the system components involved.

WP/OIS/ 1 - 34

COMPANY CONFIDENTIAL  
REPLACES: 02/01/84  
EFFECTIVE: 05/01/84

WP/OIS

## DIS UPGRADES/EXCHANGES

FROM/TO	105-1	115-2	115-3	115-4	130	130-A	130-D	130-E	140-3	140-3 +10MB	145A
105	UJ-1174	UJ-1040	UJ-1175	UJ-1176	N/A	N/A	N/A	N/A	UJ-2032	N/A	UJ-2159
105-1	N/A	UJ-1177	UJ-1178	UJ-1179	N/A	N/A	N/A	N/A	UJ-2032	N/A	UJ-2159
115-1	N/A	UJ-1043	UJ-1182	UJ-1183	N/A	N/A	N/A	N/A	UJ-2036	N/A	UJ-2160
115-2	N/A	N/A	UJ-1184	UJ-1185	N/A	N/A	N/A	N/A	UJ-2040	N/A	UJ-2161
115-3	N/A	N/A	N/A	UJ-1186	N/A	N/A	UJ-1188	N/A	UJ-2122	N/A	UJ-2162
115-4	N/A	N/A	N/A	N/A	N/A	N/A	N/A	UJ-1190	UJ-2126	N/A	UJ-2163
125	N/A	N/A	N/A	N/A	UJ-1070	N/A	N/A	N/A	UJ-2047	UJ-2048	UJ-2164
125A	N/A	N/A	N/A	N/A	N/A	UJ-1048	N/A	N/A	UJ-2054	UJ-2055	UJ-2165
130	N/A	N/A	N/A	N/A	N/A	N/A	N/A	N/A	UJ-2062	UJ-2063	UJ-2166
130A	N/A	N/A	N/A	N/A	N/A	N/A	UJ-1290	UJ-1291	UJ-2069	UJ-2070	UJ-2167
130B	N/A	N/A	N/A	N/A	N/A	N/A	UJ-1290	UJ-1291	UJ-2076	UJ-2077	UJ-2168
130C	N/A	N/A	N/A	N/A	N/A	N/A	UJ-1290	UJ-1291	UJ-2083	UJ-2084	UJ-2169
130D	N/A	N/A	N/A	N/A	N/A	N/A	N/A	UJ-1291	N/A	N/A	N/A
140-1	N/A	N/A	N/A	N/A	N/A	N/A	N/A	N/A	UJ-1050	N/A	N/A
140-2	N/A	N/A	N/A	N/A	N/A	N/A	N/A	N/A	UJ-1051	N/A	N/A
140-3	N/A	N/A	N/A	N/A	N/A	N/A	N/A	N/A	N/A	N/A	N/A

N/A = Not Available

NOTE: All orders for add-ons and upgrade equipment MUST include the work order numbers and serial numbers of the system components involved.

-----R E N T A L-----

UPGRADE JOB #	DESCRIPTION	PURCHASE PRICE	SINGLE CHARGE	OR	MONTHLY 1 YEAR
------------------	-------------	-------------------	------------------	----	-------------------

The purchase/rental charges listed include any applicable difference in prices. For purchase systems the incremental maintenance charge is also due.

DIS UPGRADES/EXCHANGES

Please note, upgrades with + 10MB in the description, customer retains his 10 megabyte disk drive.

UJ-1258	OIS-40 to OIS-50	\$ 3,300	\$ 1,400	\$ 140
UJ-1292	OIS-40 to OIS-60 (2 fan master only)	6,200	2,400	240
UJ-1293	OIS-50 to OIS-60 (2 fan master only)	4,500	1,800	180
UJ-1294	OIS-40 to OIS-60 (1 fan master only)	6,700	2,500	250
UJ-1295	OIS-50 to OIS-60 (1 fan master only)	5,000	1,900	190
UJ-1174	System 105 to 105-1 (Field Upgradable)	550	500	50
UJ-1040	System 105 to 115-2	5,500	1,000	100
UJ-1175	System 105 to 115-3	9,500	1,000	100
UJ-1176	System 105 to 115-4	12,000	1,000	100
UJ-1177	System 105-1 to 115-2	5,390	500	50
UJ-1178	System 105-1 to 115-3	8,530	1,000	100
UJ-1179	System 105-1 to 115-4	11,110	1,000	100
UJ-2032	System 105/-1 to 140-3 (Upgrade involves an exchange of serialized equipment)	25,500	3,600	360
UJ-2159	System 105/-1 to 145A (Upgrade involves an exchange of serialized equipment)	37,500	3,600	360
UJ-1043	System 115-1 to 115-2	2,200	1,000	100
UJ-1182	System 115-1 to 115-3	5,300	1,000	100
UJ-1183	System 115-1 to 115-4	7,820	1,000	100
UJ-2036	System 115-1 to 140-3 (Upgrade involves an exchange of serialized equipment)	25,200	8,000	800

NOTE: All orders for add-ons and upgrade equipment MUST include the work order numbers and serial numbers of the system components involved.

UPGRADE JOB #	DESCRIPTION	PURCHASE PRICE	----- R E N T A L -----	
			SINGLE CHARGE	OR MONTHLY 1 YEAR

The purchase/rental charges listed include any applicable difference in prices. For purchase systems the incremental maintenance charge is also due.

OIS UPGRADES/EXCHANGES (continued)

Please note, upgrades with + 10MB in the description, customer retains his 10 megabyte disk drive.

UJ-2160	System 115-1 to 145A (Upgrade involves an exchange of serialized equipment)	\$ 37,200	\$ 8,000	\$ 800
UJ-1184	System 115-2 to 115-3	4,350	1,500	150
UJ-1185	System 115-2 to 115-4	6,820	1,500	150
UJ-2040	System 115-2 to 140-3 (Upgrade involves an exchange of serialized equipment)	24,800	6,000	600
UJ-2161	System 115-2 to 145A (Upgrade involves an exchange of serialized equipment)	36,800	6,000	600
UJ-1186	System 115-3 to 115-4	4,790	2,000	200
UJ-2122	System 115-3 to 140-3 (Upgrade involves an exchange of serialized equipment)	24,400	9,000	900
UJ-2162	System 115-3 to 145A (Upgrade involves an exchange of serialized equipment)	36,400	9,000	900
UJ-2126	System 115-4 to 140-3 (Upgrade involves an exchange of serialized equipment)	24,000	13,000	1,300
UJ-2163	System 115-4 to 145A (Upgrade involves an exchange of serialized equipment)	36,000	13,000	1,300
UJ-1070	System 125 to 130 (Field Upgradable)	3,850	500	50
UJ-2047	System 125 to 140-3 (Upgrade involves an exchange of serialized equipment)	20,250	12,000	1,200
UJ-2048	System 125 to 140-3 + 10MB (Upgrade involves an exchange of serialized equipment)	23,100	6,500	650
UJ-2164	System 125 to 145A (Upgrade involves an exchange of serialized equipment)	27,390	6,500	650

NOTE: All orders for add-ons and upgrade equipment MUST include the work order numbers and serial numbers of the system components involved.

UPGRADE  
JOB #

DESCRIPTION

PURCHASE  
PRICE

-----R E N T A L-----  
SINGLE OR MONTHLY  
CHARGE 1 YEAR

The purchase/rental charges listed include any applicable difference in prices. For purchase systems the incremental maintenance charge is also due.

DIS UPGRADES/EXCHANGES (continued)

Please note, upgrades with + 10MB in the description, customer retains his 10 megabyte disk drive.

UJ-1048	System 125A to 130A (Field Upgradable)	\$ 3,850	\$ 500	\$ 50
UJ-2054	System 125A to 140-3 (Upgrade involves an exchange of serialized equipment)	20,240	12,000	1,200
UJ-2055	System 125A to 140-3 + 10MB (Upgrade involves an exchange of serialized equipment)	24,090	6,500	650
UJ-2165	System 125A to 145A (Upgrade involves an exchange of serialized equipment)	27,390	6,500	650
UJ-2062	System 130 to 140-3 (Upgrade involves an exchange of serialized equipment)	18,590	13,500	1,350
UJ-2063	System 130 to 140-3 + 10MB (Upgrade involves an exchange of serialized equipment)	22,440	8,000	800
UJ-2166	System 130 to 145A (Upgrade involves an exchange of serialized equipment)	25,740	8,000	800
UJ-2069	System 130A to 140-3 (Upgrade involves an exchange of serialized equipment)	18,590	13,500	1,350
UJ-2070	System 130A to 140-3 + 10MB (Upgrade involves an exchange of serialized equipment)	22,440	8,000	800
UJ-2167	System 130A to 145A (Upgrade involves an exchange of serialized equipment)	25,740	8,000	800
UJ-2076	System 130B to 140-3 (Upgrade involves an exchange of serialized equipment)	18,040	15,000	1,500
UJ-2077	System 130B to 140-3 + 10MB (Upgrade involves an exchange of serialized equipment)	21,890	9,500	950

NOTE: All orders for add-ons and upgrade equipment MUST include the work order numbers and serial numbers of the system components involved.



UPGRADE JOB #	DESCRIPTION	PURCHASE PRICE	-----R E N T A L-----	
			SINGLE CHARGE	OR MONTHLY 1 YEAR

The purchase/rental charges listed include any applicable difference in prices. For purchase systems the incremental maintenance charge is also due.

OIS UPGRADES/EXCHANGES (continued)

Please note, upgrades with + 10MB in the description, customer retains his 10 megabyte disk drive.

UJ-2168	System 130B to 145A (Upgrade involves an exchange of serialized equipment)	\$ 25,190	\$ 9,500	\$ 950
UJ-2083	System 130C to 140-3 (Upgrade involves an exchange of serialized equipment)	17,270	15,500	1,550
UJ-2084	System 130C to 140-3 + 10MB (Upgrade involves an exchange of serialized equipment)	21,120	10,000	1,000
UJ-2169	System 130C to 145A (Upgrade involves an exchange of serialized equipment)	24,420	10,000	1,000
UJ-1050	System 140-1 to 140-3 (Field Upgradable)	2,750	500	50
UJ-1051	System 140-2 to 140-3 (Field Upgradable)	1,650	500	50
UJ-1099	Add Expanded Memory to exist- ing OIS 125A, 130A, 140, 145A (64K). See description for model #EM-OIS	2,750	500	50
UJ-1290	130C to OIS 130D	8,000	2,000	200
UJ-1291	OIS 130A, B, C to 130D	10,000	2,000	200

NOTE: All orders for add-ons and upgrade equipment MUST include the work order numbers and serial numbers of the system components involved.



**QUANTITY DISCOUNTS FOR WORKSTATION UPGRADES**

Discounts are allowed for quantity purchases (sales only; no rentals except as noted on exception basis\*). Orders must be submitted on a single purchase order, delivery may be to multiple delivery points, but must be within six (6) months of initial order. Quantity discounts are applied per model number not on an aggregate basis except as noted on an exception basis\*. Products for which Wang publishes multi-unit discounts shall receive the higher of the applicable published multi-unit quantity discount, or the Annual Volume Agreement discount, but not both.

\* Quantity discounts for the General Workstation Upgrade Discount apply to both purchase and rental (Single Charge) prices. Discounts apply only to delivery at a single location, not to multiple delivery points.

QUANTITY ORDERED	DISCOUNT
1 - 19	0%
20 - 39	10%
40 +	15%

Computation of the discount for upgrades is calculated on either the full purchase price or the rental single charge. It does not affect the actual rental or maintenance due.

NOTE: PLEASE REFER TO THE APPROPRIATE UPGRADE CHARTS FOR THE DESIRED WORKSTATION UPGRADE. THEN REFER TO THE MODEL NUMBER LISTING ON THE FOLLOWING PAGES FOR PRICING AND OTHER PERTINENT INFORMATION.

**STANDARD  
WORKSTATION UPGRADES**

**5526 (3 Board)**

FROM/TO	5526H (16K)	5526A (32K)
5526 (16K)	WSO-3	UJ-1052
5526H (16K)	N/A	UJ-1053

NOTE: All orders for add-ons and upgrade equipment MUST include the work order numbers and serial numbers of the system components involved.

WP/OIS/ 1 - 40

COMPANY CONFIDENTIAL  
REPLACES: 02/01/84  
EFFECTIVE: 05/01/84



NOTE: PLEASE REFER TO THE APPROPRIATE UPGRADE CHARTS FOR THE DESIRED WORKSTATION UPGRADE. THEN REFER TO THE MODEL NUMBER LISTING ON THE FOLLOWING PAGES FOR PRICING AND OTHER PERTINENT INFORMATION.

STANDARD

WORKSTATION UPGRADES/EXCHANGES

5536 (2 Board)

FROM/TO	5536-1 (16K)	5536-2 (32K)	5536-3 (48K)	5536-4 (64K)	5556C (64K)
5536-1 (16K)	N/A	UJ-1054	UJ-1055	UJ-1001	UJ-1073
5536-2 (32K)	N/A	N/A	UJ-1056	UJ-1002	UJ-1074
5536-3 (48K)	N/A	N/A	N/A	UJ-1003	UJ-1075
5536-4 (64K)	N/A	N/A	N/A	N/A	UJ-1076
System 5 Workstation	UJ-2089	N/A	N/A	N/A	N/A

STANDARD

WP/OIS WORKSTATION UPGRADES/EXCHANGES TO TC WORKSTATIONS

(TC Chassis in Place)

FROM/TO	TC-5536-2 (32K)	TC-5536-3 (48K)	TC-5536-4 (64K)
5536-1 (16K)	UJ-1057	UJ-1058	UJ-1004
5536-2 (32K)	UJ-1007	UJ-1059	UJ-1005
5536-3 (48K)	N/A	UJ-1007	UJ-1006
5536-4 (64K)	N/A	N/A	UJ-1007

Workstations with the TC Connector on the back have the TC chassis. Those without the connector do not.

NOTE: The 5526A workstation is the functional equivalent of the 5536-2 workstation and will run on an OIS system.

NOTE: All orders for add-ons and upgrade equipment MUST include the work order numbers and serial numbers of the system components involved.

NOTE: PLEASE REFER TO THE APPROPRIATE UPGRADE CHARTS FOR THE DESIRED WORKSTATION UPGRADE. THEN REFER TO THE MODEL NUMBER LISTING ON THE FOLLOWING PAGES FOR PRICING AND OTHER PERTINENT INFORMATION.

STANDARD

WP/OIS WORKSTATION UPGRADES/EXCHANGES TO TC WORKSTATIONS

(No TC Chassis)

FROM/TO	TC-5536-2 (32K)	TC-5536-3 (48K)	TC-5536-4 (64K)
5536-1 (16K)	UJ-2090	UJ-2091	UJ-2092
5536-2 (32K)	UJ-2093	UJ-2094	UJ-2095
5536-3 (48K)	N/A	UJ-2096	UJ-2097
5536-4 (64K)	N/A	N/A	UJ-2098

STANDARD

ARCHIVING WORKSTATION UPGRADES

FROM/TO	AWS-4 (64K)	TC-AWS-1 (48K)	TC-AWS-4 (64K)
AWS-1 (48K)	UJ-1008	UJ-1060	UJ-1061
AWS-4 (64K)	N/A	N/A	UJ-1060
TC-AWS-1 (48K)	N/A	N/A	UJ-1008

Workstations with the TC Connector on the back have the TC chassis. Those without the connector do not.

NOTE: All orders for add-ons and upgrade equipment MUST include the work order numbers and serial numbers of the system components involved.



UPGRADE JOB #	DESCRIPTION	PURCHASE PRICE	-----R E N T A L-----	
			SINGLE CHARGE	OR MONTHLY 1 YEAR

The purchase/rental charges listed include any applicable difference in prices. For purchase systems the incremental maintenance charge is also due.

WORKSTATION UPGRADE PRICES

PLEASE REFER TO CHARTS ON PREVIOUS PAGES TO ENSURE THAT THE PROPER UPGRADE JOB IS BEING ORDERED

WS0-3	Add Horizontal Scroll to 5526	\$ 550	\$ 500	\$ 50
UJ-2089	System 5 Workstation to 5536-1 ONLY (Upgrade involves an ex- change of serializd equipment)	3,400	2,100	210

WORKSTATION MEMORY UPGRADES

UJ-1001	16K to 64K	\$ 1,500	\$ 450	\$ 45
UJ-1002	32K to 64K	1,150	450	45
UJ-1003	48K to 64K	825	450	45
UJ-1008	48K to 64K Archiving	825	450	45
UJ-1052	5526 to 5526A (32K, Horizontal Scroll)	825	450	45
UJ-1053	5526H to 5526A (32K, Horizon- tal Scroll)	825	450	45
UJ-1054	16K to 32K (2 board)	825	450	45
UJ-1055	16K to 48K (2 board)	1,150	450	45
UJ-1056	32K to 48K (2 board)	825	450	45
UJ-1073	5536-1 to 5556C	1,700	650	65
UJ-1074	5536-2 to 5556C	1,375	650	65
UJ-1075	5536-3 to 5556C	1,050	650	65
UJ-1076	5536-4 to 5556C	725	650	65
UJ-1250	64K Ergo to add Proportional Space	1,150	750	75
UJ-1225	64K/PS 5300 to Audio Option	2,200	1,000	100

NOTE: All orders for add-ons and upgrade equipment MUST include the work order numbers and serial numbers of the system components involved.

UPGRADE JOB #	DESCRIPTION	PURCHASE PRICE	-----R E N T A L-----		
			SINGLE CHARGE	OR	MONTHLY 1 YEAR

The purchase/rental charges listed include any applicable difference in prices. For purchase systems the incremental maintenance charge is also due.

TC UPGRADES

UJ-1007	TC upgrade to Workstation (same memory size)	\$ 2,000	\$ 450	\$ 45
UJ-1060	TC Upgrade to Archiving Work- station (same memory size)	2,000	450	45

WORKSTATION MEMORY AND TC UPGRADES (TC CHASSIS IN PLACE)

UJ-1004	16K to 64K with TC	\$ 3,000	\$ 450	\$ 45
UJ-1005	32K to 64K with TC	2,700	450	45
UJ-1006	48K to 64K with TC	2,400	450	45
UJ-1057	16K to 32K with TC	2,400	450	45
UJ-1058	16K to 48K with TC	2,700	450	45
UJ-1059	32K to 48K with TC	2,400	450	45
UJ-1061	48K to 64K with TC Upgrade to Archiving Workstation	2,400	450	45

WORKSTATION MEMORY AND TC UPGRADES (NO TC CHASSIS IN PLACE)

UJ-2090	5536-1 to TC-5536-2 (Upgrade involves an exchange of serialized equipment)	\$ 2,400	\$ 450	\$ 45
UJ-2091	5536-1 to TC-5536-3 (Upgrade involves an exchange of serialized equipment)	2,700	450	45
UJ-2092	5536-1 to TC-5536-4 (Upgrade involves an exchange of serialized equipment)	3,000	450	45
UJ-2093	5536-2 to TC-5536-2 (Upgrade involves an exchange of serialized equipment)	2,100	450	45
UJ-2094	5536-2 to TC-5536-3 (Upgrade involves an exchange of serialized equipment)	2,400	450	45

NOTE: All orders for add-ons and upgrade equipment MUST include the work order numbers and serial numbers of the system components involved.

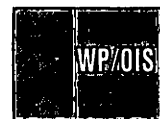

UPGRADE JOB #	DESCRIPTION	PURCHASE PRICE	-----R E N T A L-----		
			SINGLE CHARGE	OR	MONTHLY 1 YEAR

The purchase/rental charges listed include any applicable difference in prices. For purchase systems the incremental maintenance charge is also due.

WORKSTATION MEMORY AND TC UPGRADES (NO TC CHASSIS IN PLACE) (continued)

UJ-2095	5536-2 to TC-5536-4 (Upgrade involves an exchange of serialized equipment)	\$ 2,700	\$ 450	\$ 45
UJ-2096	5536-3 to TC-5536-3 (Upgrade involves an exchange of serialized equipment)	2,100	450	45
UJ-2097	5536-3 to TC-5536-4 (Upgrade involves an exchange of serialized equipment)	2,400	450	45
UJ-2098	5536-4 to TC-5536-4 (Upgrade involves an exchange of serialized equipment)	2,100	450	45

4200 WORKSTATION UPGRADES

UJ-1282	4230-0A to 4230TC	\$ 1,050	\$ 450	\$ 45
UJ-1283	4230-0A to Wang PC- Includes: PC CPU with 5 slot chassis, Monochrome Monitor Card, Local Communications Option, 5 1/5" Diskette Drive	4,425	500	50
UJ-2171	OIS-IWS to 4230-0A	2,000	400	40
UJ-2172	OIS-IWS to 4230TC	2,600	500	50

MODEL NUMBER	DESCRIPTION	INITIAL LICENSE FEE	MONTHLY LICENSE FEE	-----MONTHLY RENTAL PRICES-----			
				1 YEAR	2 YEAR	3 YEAR	5 YEAR

4250-0A to Wang PC Upgrade

PC-SS001	System Software Diskette Wang Menu Enhanced MS-DOS Operating System, Plus Interpretive BASIC (Included with all Systems)						
	Quantities of 1 to 19	\$ 200	N/A	N/A	N/A	N/A	N/A
	Quantities of 20 to 49	180	N/A	N/A	N/A	N/A	N/A
	Quantities of 50 to 149	170	N/A	N/A	N/A	N/A	N/A
	Quantities of 150 to 249	160	N/A	N/A	N/A	N/A	N/A

KEYBOARD UPGRADE

UJ-1191	Standard keyboard to standard keyboard with numeric keypad (Ergo 2 only)	\$ 900	N/A	N/A
---------	--	--------	-----	-----

NOTE: All orders for add-ons and upgrade equipment MUST include the work order numbers and serial numbers of the system components involved.

UPGRADE  
JOB #

DESCRIPTION

PURCHASE  
PRICE

-----R E N T A L-----  
SINGLE OR MONTHLY  
CHARGE 1 YEAR

The purchase/rental charges listed include any applicable difference in prices. For purchase systems the incremental maintenance charge is also due.

DIS - COMMUNICATIONS UPGRADE OPTIONS

NOTE: Order front panel (DIS-FP..) and required connector (i.e., CN-RS232) using standard model numbers and pricing to configure the complete option. Cost for installation of the complete communications options is included in price of the board as indicated below.

UJ-DIS-TC	Upgrade to TC DIS-TC ordered as upgrade (64K DCC Board)	\$ 1,825	\$ 450	\$ 45
UJ-DIS-TC1	Upgrade to TC1 OIS-TC1 ordered as upgrade (128K DCC Board)	2,375	450	45
UJ-1263	DIS-TC Upgrade to DIS-TC1 64K DCC to 128K DCC Board	1,050	450	45

SYSTEM 5 PRINTER UPGRADES

UJ-1062	5541W to 6581W 5541MC to 6581MC	\$ 2,450	\$ 450	\$ 45
UJ-1063	5541D to 6581W equivalent	2,450	450	45
UJ-1064	5541W w/TSF to 6581W w/TSF or 5541MC w/TSF to 6581MC w/TSF	2,450	450	45

PRINTER AND PERIPHERAL UPGRADES

UJ-1065	5581 to 6581 equivalent 5521 (12K) to 5521 (16K) 5531 (12K) to 5531 (16K) 5571 (12K) to 5571 (16K) PIO (12K) to PIO (16K) 5511 (System 10) to 6581 equivalent	\$ 450	\$ 450	\$ 45
UJ-1226	Paper Tensioner for FT-1	125	100	10
UJ-1066	5548 to 5548Z	1,200	1,200	120

ENVELOPE AND SHEET FEEDER UPGRADES

UJ-1071	Envelope Feeder upgrade for 6581W	\$ 250	N/A	N/A
UJ-1096	Twin Sheet Feeder upgrade for 6581W (Electronics only)	500	N/A	N/A

NOTE: All orders for add-ons and upgrade equipment MUST include the work order numbers and serial numbers of the system components involved.

UPGRADE JOB #	DESCRIPTION	PURCHASE PRICE	-----R E N T A L-----	
			SINGLE CHARGE	OR MONTHLY 1 YEAR

The purchase/rental charges listed include any applicable difference in prices. For purchase systems the incremental maintenance charge is also due.

ENVELOPE AND SHEET FEEDER UPGRADES (continued)

UJ-1196	TSF & EF Upgrade for all DW-20	\$ 275	N/A	N/A
UJ-1195	Twin Sheet Feeder	250	N/A	N/A

WANGNET UPGRADES

UJ-1227	6540-1 to 6540-1W. Upgrades system with WangNet interface	\$ 2,350	\$ 1,650	\$ 165
UJ-1228	6540-2 to 6540-2W. Upgrades system with WangNet interface	2,350	1,650	165
UJ-1229	6540-3 to 6540-3W. Upgrades system with WangNet interface	2,350	1,650	165
UJ-1230	6545 to 6545W. Upgrades system with WangNet interface	2,350	1,650	165
UJ-1251	6750-1 to 6750-1W. Upgrades system with WangNet interface	2,350	1,650	165
UJ-1252	6750-2 to 6750-2W. Upgrades system with WangNet interface	2,350	1,650	165

ALLIANCE UPGRADES

NO EM-OIS

UJ-2128	105 to Alliance 250-1 (Upgrade involves an exchange of serialized equipment)	\$ 29,200	\$ 5,500	\$ 550
UJ-2133	105 to Alliance 250-2 (Upgrade involves an exchange of serialized equipment)	36,200	5,500	550
UJ-2129	115-1 to Alliance 250-1 (Upgrade involves an exchange of serialized equipment)	27,600	8,000	800
UJ-2134	115-1 to Alliance 250-2 (Upgrade involves an exchange of serialized equipment)	34,600	8,000	800

NOTE: All orders for add-ons and upgrade equipment MUST include the work order numbers and serial numbers of the system components involved.



UPGRADE  
JOB #

DESCRIPTION

PURCHASE  
PRICE-----R E N T A L-----  
SINGLE OR MONTHLY  
CHARGE 1 YEAR

The purchase/rental charges listed include any applicable difference in prices. For purchase systems the incremental maintenance charge is also due.

ALLIANCE UPGRADES (continued)NO EM-OIS

UJ-2130	115-2 to Alliance 250-1 (Upgrade involves an exchange of serialized equipment)	\$ 26,600	\$ 9,000	\$ 900
UJ-2135	115-2 to Alliance 250-2 (Upgrade involves an exchange of serialized equipment)	33,600	9,000	900
UJ-2131	115-3 to Alliance 250-1 (Upgrade involves an exchange of serialized equipment)	25,000	9,000	900
UJ-2136	115-3 to Alliance 250-2 (Upgrade involves an exchange of serialized equipment)	32,000	9,000	900
UJ-2132	115-4 to Alliance 250-1 (Upgrade involves an exchange of serialized equipment)	24,000	13,000	1,300
UJ-2137	115-4 to Alliance 250-2 (Upgrade involves an exchange of serialized equipment)	31,000	13,000	1,300
UJ-2150	125A to Alliance 250-1 (Upgrade involves an exchange of serialized equipment)	23,000	6,500	650
UJ-2152	125A to Alliance 250-2 (Upgrade involves an exchange of serialized equipment)	30,000	6,500	650
UJ-2151	130A to Alliance 250-1 (Upgrade involves an exchange of serialized equipment)	22,000	8,000	800
UJ-2153	130A to Alliance 250-2 (Upgrade involves an exchange of serialized equipment)	29,000	8,000	800
UJ-1236	140-1 to Alliance 250-1	9,500	1,000	100
UJ-1237	140-2 to Alliance 250-1	8,500	1,000	100

NOTE: All orders for add-ons and upgrade equipment MUST include the work order numbers and serial numbers of the system components involved.

WP/OIS/ 1 - 48

COMPANY CONFIDENTIAL  
REPLACES: 02/01/84  
EFFECTIVE: 05/01/84

WP/OIS

UPGRADE JOB #	DESCRIPTION	PURCHASE PRICE	----- R E N T A L -----	
			SINGLE CHARGE	OR MONTHLY 1 YEAR

The purchase/rental charges listed include any applicable difference in prices. For purchase systems the incremental maintenance charge is also due.

ALLIANCE UPGRADES (continued)

WITH EM-OIS

UJ-1238	140-3 to Alliance 250-1	\$ 7,500	\$ 500	\$ 50
UJ-1241	145 to Alliance 250-2	7,500	500	50
UJ-1271	145A to Alliance 250-2	7,500	500	50
UJ-2138	105 to Alliance 250-1 (Upgrade involves an exchange of serialized equipment)	27,200	5,500	550
UJ-2143	105 to Alliance 250-2 (Upgrade involves an exchange of serialized equipment)	34,200	5,500	550
UJ-2139	115-1 to Alliance 250-1 (Upgrade involves an exchange of serialized equipment)	25,600	8,000	800
UJ-2144	115-1 to Alliance 250-2 (Upgrade involves an exchange of serialized equipment)	32,600	8,000	800
UJ-2140	115-2 to Alliance 250-1 (Upgrade involves a trade-in of hardware)	24,600	9,000	900
UJ-2145	115-2 to Alliance 250-2 (Upgrade involves a trade-in of hardware)	31,600	9,000	900
UJ-2141	115-3 to Alliance 250-1 (Upgrade involves a trade-in of hardware)	23,000	9,000	900
UJ-2146	115-3 to Alliance 250-2 (Upgrade involves a trade-in of hardware)	30,000	9,000	900
UJ-2142	115-4 to Alliance 250-1 (Upgrade involves an exchange of serialized equipment)	22,000	13,000	1,300
UJ-2147	115-4 to Alliance 250-2 (Upgrade involves an exchange of serialized equipment)	29,000	13,000	1,300

NOTE: All orders for add-ons and upgrade equipment MUST include the work-order numbers and serial numbers of the system components involved.

UPGRADE  
JOB #

DESCRIPTION

PURCHASE  
PRICE

-----R E N T A L-----  
SINGLE OR MONTHLY  
CHARGE 1 YEAR

The purchase/rental charges listed include any applicable difference in prices. For purchase systems the incremental maintenance charge is also due.

ALLIANCE UPGRADES (continued)

WITH EM-OIS

UJ-2154	125A to Alliance 250-1 (Upgrade involves an exchange of serialized equipment)	\$ 21,000	\$ 6,500	\$ 650
UJ-2156	125A to Alliance 250-2 (Upgrade involves an exchange of serialized equipment)	28,000	6,500	650
UJ-2155	130A to Alliance 250-1 (Upgrade involves an exchange of serialized equipment)	20,000	8,000	800
UJ-2157	130A to Alliance 250-2 (Upgrade involves an exchange of serialized equipment)	27,000	8,000	800
UJ-1244	140-1 to Alliance 250-1	7,500	1,000	100
UJ-1245	140-2 to Alliance 250-1	6,500	1,000	100
UJ-1246	140-3 to Alliance 250-1	5,500	500	50
UJ-1249	145 to Alliance 250-2	5,500	500	50
UJ-1272	145A to Alliance 250-2	5,500	500	50

SOFTWARE UPGRADES

UJ-1273	S0-6 to AL-BASIC	\$ 750	\$ 750	\$ 75
UJ-1274	OIS-CPM to AL-CPM	250	250	25
UJ-1276	OIS-3271E to AL-3271E	625	625	62.
UJ-1277	OIS-BATCH to AL-BATCH	375	375	37.
UJ-1278	OIS-TTE to AL-TTE	375	375	37.
UJ-1279	OIS-CHARTER to AL-CHARTER	500	500	50
UJ-1280	OIS-SMA to AL-SMA	500	500	50
UJ-1281	OIS-WP-PLUS to AL-WP-PLUS	500	500	50

NOTE: All orders for add-ons and upgrade equipment MUST include the work order numbers and serial numbers of the system components involved.

WP/DIS/ 1 - 50

COMPANY CONFIDENTIAL  
REPLACES: 02/01/84  
EFFECTIVE: 05/01/84

WP/OIS

UPGRADE JOB #	DESCRIPTION	PURCHASE PRICE	-----R E N T A L----- SINGLE OR MONTHLY CHARGE 1 YEAR
------------------	-------------	-------------------	---

The purchase/rental charges listed include any applicable difference in prices. For purchase systems the incremental maintenance charge is also due.

PRINTER UPGRADES

UJ-1172	Daisy or Matrix Printer to 64K	\$ 450	\$ 450	\$ 45
UJ-2158	LPS-12 to LIS-12 (For OIS 100, Alliance, and VS Systems)	7,750	2,000	200

OIS 140 OPTIONAL DISK DRIVE UPGRADES

FROM/TO	6580-2 (53.6 MB)	6580-3 (80.4 MB)
6580-1 (26.8 MB)	UJ-1011	UJ-1009
6580-2 (53.6 MB)	N/A	UJ-1010

UJ-1011	6580-1 (26.8 MB) to 6580-2 (53.6 MB) (Field Upgradable)	\$ 1,500	\$ 500	\$ 50
UJ-1009	6580-1 (26.8 MB) to 6580-3 (80.4 MB) (Field Upgradable)	2,500	500	50
UJ-1010	6580-2 (53.6 MB) to 6580-3 (80.4 MB) (Field Upgradable)	1,500	500	50

COMMUNICATIONS UPGRADES

UJ-1097 requires corresponding appropriate master upgrade from 105-130A to 140/145A. Protocol software purchased separately.

UJ-1067	TC-B2 to TC-B (pre s/n HD 2180) OCR-1 (16K) to OCR-1 (32K) (pre s/n HD 2180)	\$ 750	\$ 450	\$ 45
UJ-1068	TC-BMP to TC-B (post s/n HD 2179)	750	450	45
UJ-1069	Add TC-3 to System 5	1,500	500	50

NOTE: All orders for add-ons and upgrade equipment MUST include the work order numbers and serial numbers of the system components involved.

TRADE-IN POLICY

Upgrade job numbers have been assigned to all combinations of systems and peripheral upgrades permissible. If a purchase customer wants to move from a WPS to an OIS, it must be done via a trade-in. Likewise, 5526 workstations must be traded in for 5536 workstations to reach 48K or 64K. Allowances for hardware trade-ins follow the same format as the current trade-in policy.

Below is an adaptation of the current trade-in policy indicating the allowances:

Wang Laboratories, Inc. will accept certain Wang-manufactured items for trade-in credit when accompanied by a customer order for the purchase of new equipment as specified below. The trade-in allowance provides for the following percentage of credit on the equipment being traded in which can be applied to the current list price of the new equipment being purchased. For the purposes of trade-in, specific base purchase prices are listed in the following table under point two (2).

1. ALLOWANCE FROM BASE PURCHASE PRICE OF OLD EQUIPMENT

<u>IN THE FIRST YEAR</u>	<u>BETWEEN FIRST AND SECOND YEAR</u>	<u>BETWEEN SECOND AND THIRD YEAR</u>	<u>BEYOND THREE YEARS</u>
40%	30%	20%	\$50/Serialized item

2. BASE PURCHASE PRICE FOR TRADE-IN ALLOWANCE

<u>EQUIPMENT</u>	<u>BASE PURCHASE PRICE</u>
System 5-1 (Master and Diskette Drive)	\$\$ 2,900
System 5-2/5-3 (Master and Diskette Drive)	\$4,900
System 10/10A (Master and Diskette Drive)	\$2,720
System 20 (Master and Diskette Drive)	\$3,800
System 25-1 (Master and Diskette Drive)	\$9,000
System 25-2 (Master and Diskette Drive)	\$9,000
System 25-3 (Master and Diskette Drive)	9,000
System 30 (Master and Diskette Drive)	9,500
System 25-1 (Master only, disk drive retained)	1,800
System 25-2 (Master only, disk drive retained)	1,800
System 25-3 (Master only, disk drive retained)	1,800
System 30 (Master only, disk drive retained)	2,300
System 5 Workstation	3,000
5526 Workstation	2,000
5526H Workstation	2,000
5526A Workstation	2,000
5526/TC Workstation	3,000

- Trade-in credit cannot exceed 50% of the purchase price of the new equipment ordered.
- The trade-in schedule covers serialized equipment, including options, memory, and upgrades which are an integral part of the system.
- Trade-in credit applies only to equipment purchased from Wang Laboratories, Inc. or a duly authorized agent. The order must be accompanied by a copy of the original purchase order or other proof of ownership of the equipment to be traded in.
- Age of equipment is determined by the date the new order is received at Wang from the date of the original shipment of the traded-in equipment.
- Trade in credit does not apply to the following items:

NOTE: All orders for add-ons and upgrade equipment MUST include the work order numbers and serial numbers of the system components involved.



Cables  
 Furniture  
 Supplies  
 Software  
 Demonstration equipment  
 Inoperative damaged items  
 Equipment that has been modified by unauthorized persons  
 Stolen equipment  
 Rental equipment  
 Refurbished equipment

8. When the customer elects to keep the 5-megabyte drive on an MPS 25 or the 10-megabyte drive on the MPS 30 system, \$9,000 should be subtracted from the base price of the traded system (as done in the table in number 2 above); and \$9,000 should be subtracted from the newly ordered system (125A, 130A, or 148A only).
9. 1200 Series equipment is also covered by this policy. This obsoletes the "1200 Series Trade-In Policies" of July 24, 1978 and August 18, 1978.

NOTE: All orders for add-ons and upgrade equipment MUST include the work order numbers and serial numbers of the system components involved.

CONFIGURATION GUIDES

SYSTEM SUMMARY FOR WPS PRODUCTS

WANGWRITER™	SYSTEM 5	SYSTEM 20	SYSTEM 25	SYSTEM 30
TOTAL PERIPHERALS	N/A	2	6	14 (6 on -1) (14 on -2) (14 on -3)
MAXIMUM NUMBER WORK-STATIONS	1	1	3	13
MAXIMUM NUMBER PRINTERS	1	1	5	13

\* Any system based Telecommunications option uses one port. The option counts as one (1) towards the total number of peripherals. Please refer to the main text of the price list to determine which TC options are system based.

NOTE: All orders for add-ons and upgrade equipment MUST include the work order numbers and serial numbers of the system components involved.

WP/OIS/ 1 - 54

COMPANY CONFIDENTIAL  
REPLACES: 02/01/84  
EFFECTIVE: 05/01/84

WP/OIS

## SYSTEM SUMMARY FOR WPS PRODUCTS (continued)

THE FOLLOWING CHART SHOWS THE COMPATIBILITY OF ALL WPS AND OIS PERIPHERALS OFFERED AS THEY RELATE TO SPECIFIC MASTERS.

TO USE THIS CHART:

- 1.)
- 2.)

Determine the Master desired.  
To determine if a peripheral is compatible with the Master find the model in question in the first column, then look across to the column of the Master. If an "X" appears in the column the peripheral is supported by that Master.

	SYSTEM 5	SYSTEM 20	SYSTEM 25	SYSTEM 30
<b>INPUT PERIPHERALS</b>				
OCR-1		X	X	X
<b>OUTPUT PERIPHERALS</b>				
PTP-2		X	X	X
<b>WANGWRITER SOFTWARE</b>				
	5503A	5503D	5504S	5504D
W4-CP/M	X	X	X	X
W4-AWPS			X	X
W4-FTC-TTE			X	X
W4-FTC-BATCH			X	X
W4-FTC-2236			X	X
<b>WANGWRITER HARDWARE</b>				
W4-FTC			X	X

NOTE: All orders for add-ons and upgrade equipment MUST include the work order numbers and serial numbers of the system components involved.



WPS PRODUCT LINE (continued)

CONFIGURATION/COMPATIBILITY GUIDE

	SYSTEM 5	SYSTEM 20	SYSTEM 25	SYSTEM 30
<b>TC OPTIONS</b>				
TC-3	X			
TC-B&P		X	X	X
NM-1	X	X	X	X
NM-2	X			
<b>SOFTWARE</b>				
SO-1		X	X	X
SO-2		X	X	X
SO-3		X	X	X
SO-4		X	X	X
<b>WORKSTATIONS</b>				
ALL WPS WORKSTATIONS, AS LISTED IN THE WP/OIS PRICE LIST SECTION, ARE SUPPORTED BY THE WPS 20, 25-3 AND 30. THE ONLY EXCEPTION IS THAT THE 48K AWS IS NOT SUPPORTED BY THE WPS 20.				
<b>ERGONOMIC WORKSTATIONS</b>				
5740-4			X	X
TC-5740-4			X	X
5846-4			X	X
TC-5846-4			X	X
<b>5300 Series</b>				
5300 Display Monitor				
5320		X	X	X
5340		X	X	X
5300 Electronics Package				
5300/AL-64		X	X	X
5300 Keyboard				
5300KBD/OIS-STD		X	X	X
5300 Workstation Options				
5300/TC		X	X	X

SEE OPTIONS FOR WORKSTATIONS

NOTE: All orders for add-ons and upgrade equipment MUST include the work order numbers and serial numbers of the system components involved.

WP/DIS/ 1 - 56

COMPANY CONFIDENTIAL  
REPLACES: 02/01/84  
EFFECTIVE: 05/01/84

WP/OIS

WPS PRODUCT LINE (continued)

CONFIGURATION/COMPATIBILITY GUIDE

SYSTEM 5	SYSTEM 20	SYSTEM 25	SYSTEM 30
-------------	--------------	--------------	--------------

**COMMUNICATIONS  
WORKSTATIONS**

ALL WPS COMMUNICATIONS WORKSTATIONS, AS LISTED IN THE WP/OIS PRICE LIST SECTION, ARE SUPPORTED BY THE WPS 20, 25-3 and 30. THE ONLY EXCEPTION IS THAT THE 48K AMS IS NOT SUPPORTED BY THE WPS 20.

**PRINTERS**

5541M	X			
5541DM	X			
6581W		X	X	
6581WC		X	X	X
8533		X	X	X
8535		X	X	X
8571			X	X

SEE OPTIONS FOR PRINTERS

COMPANY CONFIDENTIAL  
 WING

NOTE: All orders for add-ons and upgrade equipment MUST include the work order numbers and serial numbers of the system components involved.

**OIS/ALLIANCE HARDWARE CONFIGURATIONS**

	SYSTEMS											
	40	50	60	105	115	125A	130A	140	145	145A	250-1	250-2
MAXIMUM * PERIPHERALS	5	9	13	4	8	16	16	32	32	32	32	32
MAXIMUM WORK- STATIONS	1	4	8	3	7	15	15	24	24	24	24	24
MAXIMUM PRINTERS	2	6	10	3	7	15	15	31	31	31	31	31
MAXIMUM DISK DRIVES	1**	1**	1**	2	2	2	2	4	4	4	4*	4*
STANDARD ON-LINE STORAGE(MB)	10**	10**	33.5**	4.2**	4.2** 8.4** 16** 32**	5	10	26.8 (-1) 53.6 (-2) 80.4 (-3)	275 + 10	275	80.4	275
OPTIONAL DISK DRIVES SUPPORTED	0	0	0	1 10MB*	1 10MB*	1 5MB*	1 10MB*	3 10MB*(2) 67MB, 80.4MB, 275MB	2 10MB*(1) 67MB, 80.4MB, 275MB	3 10MB*(2) 67MB, 80.4MB, 275MB	3 10MB*(2) 67MB, 80.4MB, 275MB	3 10MB*(2) 67MB, 80.4MB, 275MB
MAXIMUM ON-LINE STORAGE	10	10	33.5	14.2	14.2 (-1) 18.4 (-2) 26 (-3) 42 (-4)	10	20	851.8 (-1) 878.6 (-2) 905.4 (-3)	835	1,100	905.4	1,100

NOTE: \*\* These are sealed system disks

\* Any system based Telecommunications option uses one port. The option counts as one (1) towards the total number of peripherals. Please refer to the main text of the price list to determine which TC options are system based.

The OIS 125 and OIS 130 support all peripherals and software supported by the OIS 125A and OIS 130A, respectively, EXCEPT for the following:

6300	EM-OIS	OIS-SNA	OIS-SCI-TY	OIS-SLP	OIS-DOCBUILDER
OIS-TC	OIS-RW	OIS-TTE	OIS-CHARTER	SO-8	
OIS-TC1	OIS-3271E	OIS-BATCH	OIS-SMALL	OIS-READ	
WISE(6550-1)	OIS-RWMP	OIS-CPM	OIS-SPELL	OIS-MULTI	

NOTE: Alliance 250 supports all peripherals supported by the OIS 140/145 except the following

Workstations with less than 64K memory	IP41D	5548Z	PIO-1
Printers with less than 64K memory	5571	TC-B	PTP-3
	5574	OCR-1	PTP-2

\* This optional disk drive is available as a remanufactured unit only.

NOTE: All orders for add-ons and upgrade equipment MUST include the work order numbers and serial numbers of the system components involved.

OIS/ALLIANCE CONFIGURATION/COMPATIBILITY GUIDE

SOFTWARE	SYSTEMS							Minimum MS Requirements			
	40	50	60	105	115	125A	130A		140	145A	250
OIS-WP-PLUS-9	X	X	X								64K
OIS-BASIC-9	X	X	X								32K
OIS-SPELL-9	X	X	X								64K
OIS-SMSPELL-9	X	X	X								64K
OIS-CHARTER-9	X	X	X								64K
OIS-LIST-9	X	X	X								48K
OIS-SLP-9	X	X	X								48K
OIS-READ-9	X	X	X								48K
OIS-SCI-TY-9	X	X	X								N/A
OIS-DOCBldr-9	X	X	X								64K
OIS-CPM-9	X	X	X								64K
OIS-3271E-9	X	X	X								48K
OIS-BATCH-9	X	X	X								64K
OIS-TTE-9	X	X	X								64K
OIS-SMA-9	X	X	X								64K
OIS-MULTI-9	X	X	X								64K
OIS-WP-PLUS					X(-2,3,4)			X	X		64K
SD-6				X	X	X	X	X	X		32K
SD-8					X(-3,4)		X	X	X		48K
OIS-3271E				X	X	X	X	X	X		48K*
195-2116-3				X	X	X	X	X	X		48K
195-2172-3								X	X		48K
OIS-SPELL					X(-3,4)		X	X	X		64K
OIS-SCI-TY					X(-3,4)		X	X	X		N/A
OIS-READ				X	X	X	X	X	X		48K
OIS-CPM				X	X	X	X	X	X		64K
OIS-MULTI				X	X	X	X	X	X		64K
OIS-CHARTER					X(-3,4)		X	X	X		64K
OIS-DOCBUILDER					X	X	X	X	X		64K
OIS-SMSPELL				X	X	X	X	X	X		64K
OIS-SLP				X	X	X	X	X	X		48K
OIS-SMA				X	X	X	X	X	X		64K*
OIS-TTE				X	X	X	X	X	X		64K
OIS-BATCH				X	X	X	X	X	X		64K

\* Requires EM-OIS in system master

1 Refer to the Workstation/Application Matrix for specific support details for currently offered OIS/Alliance Workstations

(continued on next page)

NOTE: All orders for add-ons and upgrade equipment MUST include the work order numbers and serial numbers of the system components involved.

OIS/ALLIANCE CONFIGURATION/COMPATIBILITY GUIDE (continued)

	40	50	60	105	115	-----SYSTEMS-----	125A	130A	140	145A	250	Minimum <sup>1</sup> WS Requirements
<b>SOFTWARE</b> (continued)												
AL-WP-PLUS											X	64K
AL-WH											X	64K
AL-TIME											X	64K
AL-NOTES											X	64K
AL-VOICE											X	64K
AL-BASIC											X	64K
AL-CPM											X	64K
AL-MULTI											X	64K
AL-CHARTER											X	64K
AL-BATCH											X	64K
AL-TTE											X	64K
AL-SMA											X	64K
AL-3271E											X	64K
AL-LOGON											X	64K
MPALL											X	64K

<sup>1</sup>Refer to the Workstation/Application Matrix for specific support details for currently offered OIS/Alliance Workstations

NOTE: All orders for add-ons and upgrade equipment MUST include the work order numbers and serial numbers of the system components involved.

WP/OIS/ 1 - 60

COMPANY CONFIDENTIAL  
REPLACES: 02/01/84  
EFFECTIVE: 05/01/84



OIS/ALLIANCE PRODUCT LINE CONFIGURATION/COMPATIBILITY GUIDE

	SYSTEMS											
	40	50	60	105	115	125A	130A	140	145A	250-1	250-2	
<b>WISE</b>												
6550-1	X	X	X	X	X	X	X	X	X <sup>1</sup>	X	X	
EM-OIS				X	X	X	X	X	X			
<b>TAPE DRIVES</b>												
6509	X	X	X	X		X	X	X	X	X	X	
6529	X	X	X	X		X	X	X	X	X	X	
<b>DISK DRIVES</b>												
6560				X (-1)		X (-2,-3,-4)		X		X	X	
6560A						X	X	X				
6560B												
6560C												
6565								X	X	X	X	
6565-1								X	X	X	X	
6580-3								X	X	X	X	
<b>INPUT PERIPHERALS</b>												
OCR-1	X	X	X	X	X	X	X	X	X			
<b>TC OPTIONS</b>												
OIS-TC	X	X	X	X	X	X	X	X	X <sup>2</sup>	X	X	
OIS-TC1	X	X	X	X	X	X	X	X	X	X	X	
TC-8	X	X	X	X	X	X	X	X	X			
NM-1	X	X	X	X	X	X	X	X	X			
NM-3	X	X	X	X	X	X	X	X	X			

COMPANY CONFIDENTIAL  
 WANG

<sup>1</sup> The addition of WISE™ to the system results in an environment whereby master memory space can be consumed very quickly. In the case of systems which can support removable disk drives (6560, 6565, and 6580), part of the master memory is always occupied by system software which controls the operation of the disk drives. This reduces the amount of memory space available for system use for open files. On any OIS system, if a file is accessed through WISE by another system, that file is opened in its resident system and consumes main memory space.

To prevent master memory overload errors from occurring when WISE is implemented, it is recommended that an EM-OIS option be added to 105 and 115 systems. It is a requirement that EM-OIS be included in any 125A, 130A, 140, or 145A system which also includes a WISE option. The added memory will eliminate problems with master overload.

<sup>2</sup> For options which require external file source, it is recommended that EM-OIS be added to 125A, 130A, 140, and 145A systems which are fully configured. This would eliminate master overload errors. The following options currently require external file source:

1. 3270 Emulation
2. Remote WangNet
3. 3274 SNA Emulation

NOTE: All orders for add-ons and upgrade equipment MUST include the work order numbers and serial numbers of the system components involved.

**OIS/ALLIANCE CONFIGURATION/COMPATIBILITY GUIDE**

**WORKSTATIONS:** ALL OIS WORKSTATIONS AS LISTED IN THE WP/OIS PRICE LIST, ARE SUPPORTED BY ALL OIS MASTERS. IN ADDITION TO THOSE LISTED IN THE WORKSTATIONS SECTION, ALL OIS MASTERS WILL SUPPORT THE 48K ARCHIVING WORKSTATIONS LISTED AS WPS WORKSTATIONS. ALLIANCE 250 MASTERS WILL SUPPORT ANY 64K OIS WORKSTATIONS.

**COMMUNICATION WORKSTATIONS:** ALL OIS COMMUNICATIONS WORKSTATIONS, AS LISTED IN THE WP/OIS PRICE LIST, ARE SUPPORTED BY ALL OIS MASTERS. IN ADDITION TO THOSE LISTED IN THE OIS COMMUNICATIONS WORKSTATIONS SECTION, ALL OIS MASTERS WILL SUPPORT THE 32K COMMUNICATIONS WORKSTATIONS AND THE 48K ARCHIVING WORKSTATIONS.

WORKSTATIONS	SYSTEMS									
	40	50	60	105	115	125A	130A	140	145A	250
OIS-TWS	X									
5536-4		X	X		X	X	X	X	X	X
AMS-4		X	X	X	X	X	X	X	X	X
AMS-C4 <sup>1</sup>		X	X	X	X	X	X	X	X	X
5740-4		X	X	X	X	X	X	X	X	X
5556C <sup>1</sup>		X	X	X	X	X	X	X	X	X
4230-OA		X	X	X	X	X	X	X	X	X
4250-OA		X	X	X	X	X	X	X	X	X
5310 Monitor <sup>2</sup>										X
5320 Monitor		X	X	X	X	X	X	X	X	X
5230 Monitor										X
5240 Monitor		X	X	X	X	X	X	X	X	X
5300/AL-64 <sup>2</sup>		X	X	X	X	X	X	X	X	X
5300W		X	X	X	X	X	X	X	X	X
5300/PS		X	X	X	X	X	X	X	X	X
5300W/PS		X	X	X	X	X	X	X	X	X
5300/AL-AUDIO										X
5300W/AUD										X
5300/AUDIO-PS										X
5300W/AUD-PS										X
5300/VS-IIS64 <sup>1</sup>		X	X	X	X	X	X	X	X	X
5300KBD/OIS-UNI <sup>2</sup>		X	X	X	X	X	X	X	X	X
5300/TC		X	X	X	X	X	X	X	X	X
5300 Headset										X
5300 Foot Pedal										X
5300 Telset										X
6340 Monitor		X	X	X	X	X	X	X	X	X
6300/OIS-64		X	X	X	X	X	X	X	X	X
UNI/KBD-STD		X	X	X	X	X	X	X	X	X
<b>TC Workstations</b>										
TC-5536-4		X	X	X	X	X	X	X	X	X
TC-AMS-4		X	X	X	X	X	X	X	X	X
TC-AMS-C4 <sup>1</sup>		X	X	X	X	X	X	X	X	X
TC-5556C <sup>1</sup>		X	X	X	X	X	X	X	X	X
TC-5740-4		X	X	X	X	X	X	X	X	X
230TC		X	X	X	X	X	X	X	X	X

<sup>1</sup> Although workstation is supported by all indicated systems, Remote WangNet is supported only on the OIS 50, 60/115-2,3,4/130A/140/145A.

<sup>2</sup> 5300 Series Monitor, Keyboard, and Electronics Packages must each be specified.

NOTE: All orders for add-ons and upgrade equipment MUST include the work order numbers and serial numbers of the system components involved.

## OIS/ALLIANCE CONFIGURATION/COMPATIBILITY GUIDE

	-----SYSTEMS-----									
	40	50	60	105	115	125A	130A	140	145A	250
<b>PRINTERS</b>										
OIS-PTR-20	X	X	X							
6581W-1	X	X	X	X	X	X	X	X	X	X
6581MC-1	X	X	X	X	X	X	X	X	X	X
5581MD-1	X	X	X	X	X	X	X	X	X	X
DM/OS-20	X	X	X	X	X	X	X	X	X	X
DM/OS-55	X	X	X	X	X	X	X	X	X	X
5533-1	X	X	X	X	X	X	X	X	X	X
5535-1	X	X	X	X	X	X	X	X	X	X
5574	X	X	X	X	X	X	X	X	X	
5577				X	X	X	X	X	X	
5577-9	X	X	X							
5577A										X
LPS-12				X	X	X	X	X	X	
LIS-12				X	X	X	X	X	X	
LPS-9		X	X							
LIS-9	X	X	X							
LPS-12A										X
LIS-12A										X

NOTE: All orders for add-ons and upgrade equipment MUST include the work order numbers and serial numbers of the system components involved.



**WORKSTATION/APPLICATION MATRIX**

-----  
 WORKSTATION  
 -----

<b>APPLICATION</b>	<b>OIS-IWS</b>	<b>AMS-4</b>	<b>AMS-C4</b>	<b>5740-4</b>	<b>5556C</b>	<b>6300</b>	<b>4230-0A</b>	<b>PC with PC-PM041</b>	<b>4250-0A</b>
WP Plus w/graphics	X					X	X	X	
WP Plus	X	X	X	X	X	X	X	X	X
BASIC	X	X	X	X	X	X	X	X	X
TC within BASIC									
Spelling Verifier	X	X	X	X	X	X	X	X	X
CHARTER Graphics	X					X	X	X	
List Processing	X	X	X	X	X	X	X	X	X
Readability Index	X	X	X	X	X	X	X	X	X
SCI/TY (Fixed Pitch)	X				X	X			
SCI/TY (Proportional Space)					X				
Scientific PROM		X		X					
Proportional Space									
Document Builder	X	X	X	X	X	X	X	X	X
CP/M	X	X	X	X	X	X	X	X	X
TC within CP/M									
Multiplan	X	X	X	X	X	X	X	X	X
Workstation TC (DIS only)									
Alliance (except voice)	X	X	X	X	X	X	X	X	X
Alliance (incl. voice)									
Remote WangNet	X				X	X	X	X	X
Archiving (8 inch)		X	X	X					
Archiving (5 1/4 inch)								X	X

NOTE: All orders for add-ons and upgrade equipment MUST include the work order numbers and serial numbers of the system components involved.

WP/OIS/ 1 - 64

COMPANY CONFIDENTIAL  
 REPLACES: 02/01/84  
 EFFECTIVE: 05/01/84

WP/OIS

WORKSTATION/APPLICATION MATRIX (continued)

APPLICATION	-----WORKSTATION-----							
	4230TC	TC-5536-4	TC-AMS-4	TC-AMS-C4	5740-4	TC-5556C	TC-5740-4	5300/TC
WP Plus w/graphics	X							
WP Plus	X	X	X	X	X	X	X	X
BASIC	X	X	X	X	X	X	X	X
TC within BASIC	X	X	X	X	X	X	X	X
Spelling Verifier	X	X	X	X	X	X	X	X
CHARTER Graphics	X							
List Processing	X	X	X	X	X	X	X	X
Readability Index	X	X	X	X	X	X	X	X
SCI/TY (Fixed Pitch)	X							
SCI/TY (Proportional Space)								
Scientific PROM								
Proportional Space								
Document Builder	X	X	X	X	X	X	X	X
CP/H	X	X	X	X	X	X	X	X
TC within CP/H	X	X	X	X	X	X	X	X
Multiplan	X	X	X	X	X	X	X	X
Workstation TC (OIS only)	X	X	X	X	X	X	X	X
Alliance (except voice)	X	X	X	X	X	X	X	X
Alliance (incl. voice)								
Remote WangNet	X					X		
Archiving (8 inch)			X	X	X		X	
Archiving (5 1/4 inch)								

COMPANY CONFIDENTIAL  
 WANG

NOTE: All orders for add-ons and upgrade equipment MUST include the work order numbers and serial numbers of the system components involved.

WORKSTATION/APPLICATION MATRIX

APPLICATION	-----WORKSTATION-----								
	5300/AL-64	5300W	5300/PS	5300W/PS	5300/AL-AUD	5300W/AUD	5300/AUDIO-PS	5300/AUD-PS	5300/VS-IIS64
WP Plus w/graphics									
WP Plus	X	X	X <sup>1</sup>	X <sup>1</sup>	X <sup>1</sup>	X <sup>1</sup>	X <sup>1</sup>	X <sup>1</sup>	X
BASIC	X	X	X	X	X	X	X	X	X
TC within BASIC	X <sup>2</sup>	X <sup>2</sup>	X <sup>2</sup>	X <sup>2</sup>	X <sup>2</sup>	X <sup>2</sup>	X <sup>2</sup>	X <sup>2</sup>	X <sup>2</sup>
Spelling Verifier	X	X	X	X	X	X	X	X	X
CHARTER Graphics									
List Processing	X	X	X	X	X	X	X	X	X
Readability Index	X	X	X	X	X	X	X	X	X
SCI/TY (Fixed Pitch)			X	X			X	X	
SCI/TY (Proportional Space)			X	X	X		X	X	
Scientific PROM	X								
Proportional Space			X	X			X	X	
Document Builder	X	X	X	X	X	X	X	X	X
CP/M	X	X	X	X	X	X	X	X	X
TC within CP/M	X <sup>2</sup>	X <sup>2</sup>	X <sup>2</sup>	X <sup>2</sup>	X <sup>2</sup>	X <sup>2</sup>	X <sup>2</sup>	X <sup>2</sup>	X <sup>2</sup>
Multiplan	X	X	X	X	X	X	X	X	X
Workstation TC (OIS only)	X <sup>2</sup>	X <sup>2</sup>	X <sup>2</sup>	X <sup>2</sup>	X <sup>2</sup>	X <sup>2</sup>	X <sup>2</sup>	X <sup>2</sup>	X <sup>2</sup>
Alliance (except voice)	X	X	X	X	X	X	X	X	X
Alliance (incl. voice)					X	X	X	X	
Remote WangNet		X		X		X			X
Archiving (8 inch)									
Archiving (5 1/4 inch)									

<sup>1</sup> NOTE: PS and Audio are not supported within WP Plus. When using WP Plus, this workstation will function as a standard 64K workstation.

<sup>2</sup> NOTE: Workstation TC on 5300 Series workstation requires a 5300/TC option board.

NOTE: All orders for add-ons and upgrade equipment MUST include the work order numbers and serial numbers of the system components involved.

CONFIGURATION GUIDE

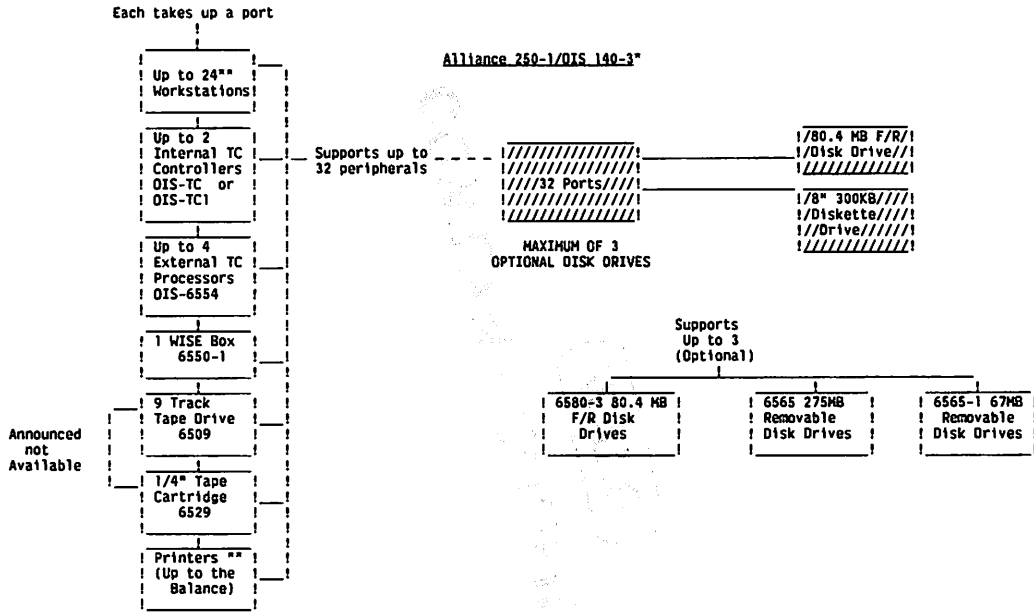

Please refer to the main text of the price list to determine which workstations and printers are supported.

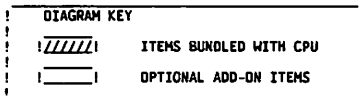

\* Alliance Master includes 128K memory. OIS Master includes 64K memory.

\*\* 64K Workstations and 64K Printers are required for use in Alliance configurations

NOTE: Customers upgrading from OIS to Alliance can still use the existing 10MB drives on their systems.

NOTE: All orders for add-ons and upgrade equipment MUST include the work order numbers and serial numbers of the system components involved.

CONFIGURATION GUIDE

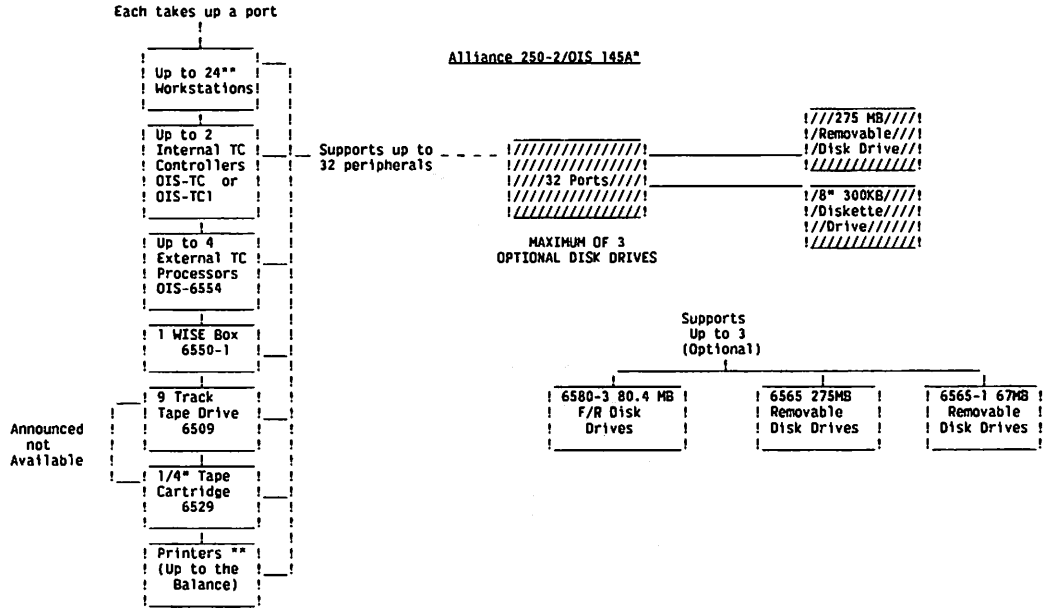

Please refer to the main text of the price list to determine which workstations and printers are supported.

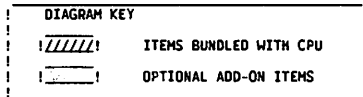

\* Alliance Master includes 128K memory. OIS Master includes 64K memory.  
 \*\* 64K Workstations and 64K Printers are required for use in Alliance configurations.  
 NOTE: Customers upgrading from OIS to Alliance can still use the existing 10MB drives on their systems.

NOTE: All orders for add-ons and upgrade equipment MUST include the work order numbers and serial numbers of the system components involved.



CONFIGURATION/COMPATIBILITY GUIDE PRINTER OPTIONS

	TSF-01 DOMESTIC	TSF-03 INT'L	TSF-05 DOMESTIC	TSF-06 INTW'L	TSF-31 DOMESTIC	TSF-33 INT'L	TSF-41 DOMESTIC	TSF-43 INT'L	EF-1 DOMESTIC 60 Hz	EF-2 INT'L 50 Hz	EF-3 INT'L 60 Hz	DSF-55
5541W	X	X										
5541WC			X	X								
-----												
6581W, 6581W-1					X	X			X	X	X	
6581WC, 6581WC-1							X	X				
DM/OS-20					X	X			X	X	X	
DM/OS-55												X

NOTE: ONLY ONE ADD ON IS APPLICABLE TO EACH PRINTER.  
 FOR EXAMPLE, A SINGLE 6581W CAN NOT SUPPORT BOTH A TWIN SHEET FEEDER AND ENVELOPE FEEDER

CONFIGURATION/COMPATIBILITY GUIDE WORKSTATION OPTIONS

	5506-x (TC-)5536-x	AMS-x TC-AMS-x	(TC-)5556C	(TC-)5937 (TC-)5947	(TC-)5938	(TC-)5939
NK-1	X	X	N/A	N/A	N/A	N/A

NOTE: ONLY ONE ADD ON IS AVAILABLE FOR EACH WORKSTATION.  
 FOR EXAMPLE, A SINGLE NK-1 PER WORKSTATION

A Numeric Key pad is standard on all 5556C Workstations

NOTE: All orders for add-ons and upgrade equipment MUST include the work order numbers and serial numbers of the system components involved.

The following represents the suggested limits on the number of peripherals per specified type of system in a WISE™ environment without the use of EM-OIS.

SYSTEM	TOTAL CONCURRENTLY <sup>1</sup> CONNECTED PERIPHERALS
OIS 105	20
OIS 115-1	
OIS 115-2	20
OIS 115-3	
OIS 115-4	
OIS 125A	
OIS 130A/B/C	12
OIS 140-1	
OIS 140-2	
OIS 140-3	
OIS 145A	8

NOTE: If EM-OIS is employed the above limitations are not applicable; i.e. a "fully loaded" system can be WISED to three other "fully loaded" systems if EM-OIS is used at each Master.

It is required that EM-OIS be used when any 125A, 130A, 140 or 145A configuration utilizes WISE, 3270 and/or Remote Cluster Facility applications.

<sup>1</sup> TOTAL CONCURRENTLY CONNECTED AND ACTIVE PERIPHERALS includes all locally attached and WISE™ connected peripherals (workstations and printers). The total number of peripherals can be derived through any combination of devices. For example, a maximum of eight (8) local and WISED peripherals can be supported, without EM-OIS, on each 140/145A system.

NOTE: All orders for add-ons and upgrade equipment MUST include the work order numbers and serial numbers of the system components involved.

WP/OIS/ 1 - 70

COMPANY CONFIDENTIAL  
REPLACES: 02/01/84  
EFFECTIVE: 05/01/84

WP/OIS

CONFIGURATION GUIDE - 5300 SERIES

BASIC FUNCTIONS IO

DISPLAY

	<u>5310</u>	<u>5320</u>	<u>5330</u>	<u>5340</u>
WP/OIS/ALLIANCE 250 5300/AL-64	NO	YES	NO	YES
ALLIANCE 250 ONLY 5300/AUDIO	YES	NO	YES	NO
VS ONLY				
5300/VS-DP	NO	YES	NO	YES
5300/VS-IIS32	NO	YES	NO	YES
5300/VS-IIS64	NO	YES	NO	YES
VS ALLIANCE ONLY 5300/VS-AL-AUDIO	YES	NO	YES	NO

5300/TC  
TELESET

ORDER SEPARATELY FOR NON-VS WORKSTATIONS  
ORDER SEPARATELY TELEPHONE FOR AUDIO WORKSTATIONS (INT'L RQD)

KEYBOARD

	<u>5300KBD/ OIS-STD</u>	<u>5300KBD/ OIS-EXP</u>	<u>5300KBD/ DP-STD</u>	<u>5300KBD/ DP-EXP</u>	<u>5300KBD/ IIS-STD</u>	<u>5300KBD/ IIS-EXP</u>
WP/OIS/ALLIANCE 250 5300/AL-64	YES	YES	NO	NO	NO	NO
ALLIANCE 250 ONLY 5300/AUDIO	YES	YES	NO	NO	NO	NO
VS ONLY						
5300/VS-DP	NO	NO	YES	YES	NO	NO
5300/VS-IIS32	NO	NO	NO	NO	YES	YES
5300/VS-IIS64	NO	NO	NO	NO	YES	YES

NOTE: All orders for add-ons and upgrade equipment MUST include the work order numbers and serial numbers of the system components involved.



DATA COMMUNICATIONS CONFIGURATIONS

New OIS/ALLIANCE TC Ordering Procedure.

The new TC ordering procedure requires the selection of at least three different model numbers to configure the desired communications capability. These model numbers each come from a different category, category 1 for the front panel, category 2 for the data communications controller board itself and category 3 for the network interface connector.

**CATEGORY ONE** supplies the appropriate front panel assembly which holds light indicators, and certain switches. The hardware supplied with the front panel varies with the system it is to be installed in, so it is important that the model number ordered reflect the proper system type (i.e. 105, 115, 140 etc.). Also note that the OIS 140 and 145A both support two internal TC controllers. Again, the model number ordered must reflect the correct slot the hardware is to be used for.

**CATEGORY TWO** is the Data Communications Board itself. It is important that you reference the software/hardware compatibility chart supplied below. This will indicate if the TC software the customer wishes requires the OIS-TC or OIS-TC1 board (please note that this board is used for both the OIS and Alliance product lines).

**CATEGORY THREE** supplies the connector and cable required to actually connect to the appropriate communications network. A 25 foot cable is shipped with each option.

On the OIS/Alliance product lines, only two situations exist that would require more than three model numbers to be ordered. The first is if the communications option is to be installed outside of the OIS/Alliance chassis. This will require a slot in the OIS-6554 external chassis, and if one is not available it will also need to be ordered. The second situation is if the customer wishes to take advantage of the new auto dial function available in some of the new software. This requires that both the RS-232 and RS-366 connector options be purchased.

SOFTWARE CAPABILITIES MATRIX

SOFTWARE PACKAGE	64K DCC		128K DCC			SOFTWARE PACKAGE	64K DCC		128K DCC		
	---CATEGORY 2---		----CATEGORY 3----				---CATEGORY 2---		----CATEGORY 3----		
OIS	OIS-TC	OIS-TC1	RS-232	RS-366	X21	ALLIANCE	OIS-TC	OIS-TC1	RS-232	RS-366	X21
OIS-RWH "	X		X								
OIS-RMNP	X		X	X							
OIS-3271E "	X		X			AL-3271E "	X			X	
OIS-SNA "		X	X			AL-SNA "		X		X	
OIS-TTE	X		X	X		AL-TTE	X			X	X
OIS-BATCH	X		X			AL-BATCH	X			X	

NOTE: \*Indicates that the software requires a dedicated Data Communications controller - OIS-TC, OIS-TC1 due to use of a dedicated line.

NOTE: Any software which minimally requires the 64K (OIS-TC) board can also utilize the largest memory, 128K board (OIS-TC1).

NOTE: All orders for add-ons and upgrade equipment MUST include the work order numbers and serial numbers of the system components involved.

WORD PROCESSING SYSTEMS  
ENTITLED SUPPORT SERVICES SUMMARY

Check Here if Acquired	SUPPORT DESCRIPTION	Activity Codes	Support Hours Up to-	Site Loc. Wang/Cust	Class Training Up to-	# of Class Attendees at No Charge
—	<u>WPS 5</u>					
	Pre-Installation Meeting	<u>EP01</u>	<u>2 hrs.</u>	<u>— X</u>	<u>—</u>	<u>—</u>
	Basic Word Processing Training	<u>ET03</u>	<u>—</u>	<u>X —</u>	<u>16 hrs.</u>	<u>1 K</u>
	Technical Consultation	<u>EC01</u>	<u>2 hrs.</u>	<u>— X</u>	<u>—</u>	<u>—</u>
—	<u>WPS 20, 7520T</u>					
	Pre-Installation Meeting	<u>EP01</u>	<u>2 hrs.</u>	<u>— X</u>	<u>—</u>	<u>—</u>
	Basic Word Processing Training	<u>ET03</u>	<u>—</u>	<u>X —</u>	<u>16 hrs.</u>	<u>1 K</u>
	Mathpak Training*	<u>ET05</u>	<u>—</u>	<u>X —</u>	<u>4 hrs.</u>	<u>1 K</u>
	Technical Consultation	<u>EC01</u>	<u>2 hrs.</u>	<u>— X</u>	<u>—</u>	<u>—</u>
—	<u>WPS 25 &amp; 30: 7525T &amp; 7530T</u>					
	Pre-Installation Meeting	<u>EP01</u>	<u>2 hrs.</u>	<u>— X</u>	<u>—</u>	<u>—</u>
	Basic Word Processing Training	<u>ET03</u>	<u>—</u>	<u>X —</u>	<u>16 hrs.</u>	<u>1 K</u>
	Mathpak Training*	<u>ET05</u>	<u>—</u>	<u>X —</u>	<u>4 hrs.</u>	<u>1 K</u>
	Technical Consultation	<u>EC01</u>	<u>4 hrs.</u>	<u>— X</u>	<u>—</u>	<u>—</u>

WANG  
COMPANY CONFIDENTIAL

\* Mathpak training will only be given if Mathpak software is purchased.

ENTITLED SUPPORT SERVICES DOCUMENTATION: Wang will provide one complete set of user reference and/or training documentation per system.

The support service specified here is Entitled Support to be delivered within 90 days of installation in accordance with Wang Policy and is provided at no additional charge with the equipment procurement. If support services not specified here are requested, the service may be provided in accordance with Wang Policies and at Wang's per call rates and terms then in effect.

\* K = Key Operator

\*\* The customer is entitled to Basic Word Processing training for one Key Operator for every ten workstations procured with the initial system order. This does not apply when Professional Computers are purchased to serve as terminals on the host.

NOTE: All orders for add-ons and upgrade equipment MUST include the work order numbers and serial numbers of the system components involved.

OFFICE INFORMATION SYSTEMS  
ENTITLED SUPPORT SERVICES SUMMARY

Check Here if Acquired	SUPPORT DESCRIPTION	Activity Codes	Support Hours Up to	Site Loc. Wang/Cust	Class Training Up to	# of Class Attendees at No Charge **
—	<u>QIS 40, 50, 60, 105, 115</u>					
	Pre-Installation Seminar	ET02	2 hrs.	X or X *		2 Contacts
	Pre-Installation Meeting	EP01	2 hrs.	X		
	Basic Word Processing Training	ET01		X	16 hrs.	1 K
	System Administration Course	ET01		X	16 hrs.	1 K
	Consultation	EI 01	2 hrs.	X	X	
	Glossary Training	ET09		X	4 hrs.	1 K
	Mathpak Training	ET05		X	4 hrs.	1 K
	Technical Consultation	EC01	8 hrs.	X	X	
—	<u>QIS 130, 140, 145A</u>					
	Pre-Installation Seminar	ET02	2 hrs.	X or X *		2 Contacts
	Pre-Installation Meeting	EP01	2 hrs.	X		
	Basic Word Processing Training	ET01		X	16 hrs.	1 K & 1 A***
	System Administration Course	ET01		X	24 hrs.	1 K & 1 A
	Consultation	EI 01	2 hrs.	X	X	
	Glossary Training	ET09		X	4 hrs.	1 K
	Mathpak Training	ET05		X	4 hrs.	1 K
	Technical Consultation	EC01	16 hrs.	X	X	

COMPANY CONFIDENTIAL

ENTITLED SUPPORT SERVICES DOCUMENTATION: Wang will provide one complete set of user reference and/or training documentation per system.

The support service specified here is Entitled Support to be delivered within 90 days of installation in accordance with Wang Policy and is provided at no additional charge with the equipment procurement. If support services not specified here are requested, the service may be provided in accordance with Wang Policies and at Wang's per call rates and terms then in effect.

\* Location of the pre-install seminar will be determined by Wang in order to best utilize Wang and customer resources.

\*\* K = Key Operator  
A = System Administrator

\*\*\* The customer is entitled to Basic Word Processing training for one Key Operator for every ten workstations procured with the initial system order. This does not apply when Professional Computers are purchased to serve as terminals on the host.

NOTE: All orders for add-ons and upgrade equipment MUST include the work order numbers and serial numbers of the system components involved.

ALLIANCE SYSTEMS  
ENTITLED SUPPORT SERVICES SUMMARY

<u>SUPPORT DESCRIPTION</u>	<u>Activity Codes</u>	<u>Support Hours Up to-</u>	<u>Site Loc. Wang/Cust</u>	<u>Class Training Up to-</u>	<u># of Class Attendees at No Charge</u>
<b>ALLIANCE 250</b>					
<b>Pre-Installation</b>					
Pre-Installation Seminar	<u>ET02</u>	<u>3 hrs.</u>	<u>X</u>	<u>          </u>	<u>N Contacts</u>
Pre-Installation Meeting	<u>EP01</u>	<u>12 hrs.</u>	<u>      X</u>	<u>          </u>	<u>          </u>
Basic Word Processing Training	<u>ET03</u>	<u>          </u>	<u>      X</u>	<u>16 hrs.</u>	<u>1 K and 1 A**</u>
System Administration Course	<u>ET01</u>	<u>      X</u>	<u>24 hrs.</u>	<u>1 K and 1 A</u>	<u>          </u>
<b>Installation</b>					
Consultation	<u>EI 01</u>	<u>4 hrs.</u>	<u>      X</u>	<u>          </u>	<u>          </u>
<b>Post-Installation</b>					
Glossary Training	<u>ET09</u>	<u>          </u>	<u>      X</u>	<u>4 hrs.</u>	<u>1 K</u>
Mathpak Training	<u>ET05</u>	<u>          </u>	<u>      X</u>	<u>4 hrs.</u>	<u>1 K</u>
Technical Consultation	<u>EC01</u>	<u>8 hrs.</u>	<u>      X</u>	<u>          </u>	<u>          </u>

ENTITLED SUPPORT SERVICES DOCUMENTATION: Wang will provide one complete set of user reference and/or training documentation per system.

The support service specified here is Entitled Support to be delivered within 90 days of installation in accordance with Wang Policy and is provided at no additional charge with the equipment procurement. If support services not specified here are requested, the service may be provided in accordance with Wang Policies and at Wang's per call rates and terms then in effect.

\* K = Key Operator  
A = System Administrator

\*\* The customer is entitled to Basic Word Processing training for one Key Operator for every ten workstations procured with the initial system order. This does not apply when Professional Computers are purchased to serve as terminals on the host.

NOTE: All orders for add-ons and upgrade equipment MUST include the work order numbers and serial numbers of the system components involved.

WORD PROCESSING SYSTEM UPGRADES/EXCHANGES  
ENTITLED SUPPORT SERVICES SUMMARY

Check Here if Acquired	SUPPORT DESCRIPTION	Activity Codes	Support Hours Up to	Site Loc. Wang/Cust	Class Training Up to	# of Class Attendees at No Charge
	<u>WPS 5 to WPS 20/7520T</u>					
	Pre-Installation					
	Meeting	<u>EP01</u>	<u>2 hrs.</u>	<u>   </u> <u>X</u>	<u>   </u>	<u>   </u>
	Mathpak Training	<u>ET05</u>	<u>   </u>	<u>X</u> <u>   </u>	<u>4 hrs.</u>	<u>1 K</u>
	<u>WPS 5 to WPS 25 &amp; 30: 7525T &amp; 7530T</u>					
	Pre-Installation					
	Meeting	<u>EP01</u>	<u>2 hrs.</u>	<u>   </u> <u>X</u>	<u>   </u>	<u>   </u>
	Mathpak Training	<u>ET05</u>	<u>   </u>	<u>X</u> <u>   </u>	<u>4 hrs.</u>	<u>1 K</u>
	Technical Consultation	<u>EC01</u>	<u>2 hrs.</u>	<u>   </u> <u>X</u>	<u>   </u>	<u>   </u>
	<u>WPS 20 to WPS 25 &amp; 30: 7525T &amp; 7530T</u>					
	Pre-Installation					
	Meeting	<u>EP01</u>	<u>2 hrs.</u>	<u>   </u> <u>X</u>	<u>   </u>	<u>   </u>
	Technical Consultation	<u>EC01</u>	<u>2 hrs.</u>	<u>   </u> <u>X</u>	<u>   </u>	<u>   </u>

ENTITLED SUPPORT SERVICES DOCUMENTATION: Wang will provide one complete set of user reference and/or training documentation per system.

The support service specified here is Entitled Support to be delivered within 90 days of installation in accordance with Wang Policy and is provided at no additional charge with the equipment procurement. If support services not specified here are requested, the service may be provided in accordance with Wang Policies and at Wang's per call rates and terms then in effect.

\* K = Key Operator

NOTE: All orders for add-ons and upgrade equipment MUST include the work order numbers and serial numbers of the system components involved.

WORD PROCESSING SYSTEM AND OFFICE INFORMATION SYSTEM  
UPGRADES/EXCHANGES  
ENTITLED SUPPORT SERVICES SUMMARY

Check Here if Acquired	SUPPORT DESCRIPTION	Activity Codes	Support Hours Up to-	Site Loc. Wang/Cust	Class Training Up to-	# of Class Attendees at No. Charge **
	<u>WPS 5, 20, 25, 30 to OIS 40, 50, 60, 105, 115</u>					
	Pre-Installation Seminar	ET02	2 hrs.	X or X *		2 Contacts
	Pre-Installation Meeting	EP01	2 hrs.	X		
	System Administration Course	ET01		X	16 hrs.	1 A
	Consultation	ET 01	2 hrs.	X	X	
	Glossary Training	ET09		X	4 hrs.	1 K
	Mathpak Training	ET05		X	4 hrs.	1 K
	Technical Consultation	EC01	4 hrs.	X		
	<u>WPS 5, 20, 25, 30 to OIS 130, 140, 145A</u>					
	Pre-Installation Seminar	ET02	2 hrs.	X or X *		2 Contacts
	Pre-Installation Meeting	EP01	2 hrs.	X		
	Basic Word Processing Training	ET03		X	16 hrs.	1 K ***
	System Administration Course	ET01		X	24 hrs.	1 K and 1 A
	Consultation	ET 01	2 hrs.	X	X	
	Glossary Training	ET09		X	4 hrs.	1 K
	Mathpak Training	ET05		X	4 hrs.	1 K
	Technical Consultation	EC01	8 hrs.	X		

ENTITLED SUPPORT SERVICES DOCUMENTATION: Wang will provide one complete set of user reference and/or training documentation per system.

The support service specified here is entitled Support to be delivered within 90 days of installation in accordance with Wang Policy and is provided at no additional charge with the equipment procurement. If support services not specified here are requested, the service may be provided in accordance with Wang Policies and at Wang's per call rates and terms then in effect.

\* The location of pre-install seminar will be determined by Wang in order to best utilize Wang and customer resources.

\*\* K = Key Operator  
A = System Administrator

\*\*\* The customer is entitled to Basic Word Processing training for one Key Operator for every ten workstations procured with the initial system order. This does not apply when Professional Computers are purchased to serve as terminals on the host.

NOTE: All orders for add-ons and upgrade equipment MUST include the work order numbers and serial numbers of the system components involved.

OFFICE INFORMATION SYSTEM AND ALLIANCE  
UPGRADES/EXCHANGES  
ENTITLED SUPPORT SERVICES SUMMARY

Check Here if Acquired	SUPPORT DESCRIPTION	Activity Codes	Support Hours Up to-	Class Site Loc. Wang/Cust	# of Class Training Up to-	Attendees at No Charge
—	<u>OIS 40, 50, 60, 105, 115 to OIS 130, 140, 145A</u>					
	Pre-Installation Meeting	EP01	2 hrs.	X		
	Basic Word Processing Training	ET03		X	16 hrs.	1 A **
	System Administration Course	ET01		X	24 hrs.	1 A
	Consultation	ET 01	2 hrs.	X		
	Technical Consultation	EC01	8 hrs.	X		
—	<u>OIS to Alliance 250</u>					
	Pre-Installation Seminar	ET02	3 hrs.	X		2 Contacts
	Pre-Installation Meeting	EP01	12 hrs.	X		
	System Administration Course	ET01		X	24 hrs.	1 K and 1 A
	Consultation	ET 01	4 hrs.	X		
	Technical Consultation	EC01	8 hrs.	X		

ENTITLED SUPPORT SERVICES DOCUMENTATION: Wang will provide one complete set of user reference and/or training documentation per system.

The support service specified here is Entitled Support to be delivered within 90 days of installation in accordance with Wang Policy and is provided at no additional charge with the equipment procurement. If support services not specified here are requested, the service may be provided in accordance with Wang Policies and at Wang's per call rates and terms then in effect.

\* K = Key Operator  
A = System Administrator

\*\* The customer is entitled to Basic Word Processing training for one Key Operator for every ten workstations procured with the initial system order.

NOTE: All orders for add-ons and upgrade equipment MUST include the work order numbers and serial numbers of the system components involved.

WISE  
ENTITLED SUPPORT SERVICES SUMMARY

<u>SUPPORT DESCRIPTION</u>	<u>Activity Codes</u>	<u>Support Hours Up to</u>	<u>Site Loc. Wang/Cust</u>
<u>Installation</u>			
--Consultation	<u>ET 01</u>	<u>4 hrs.</u>	___ <u>X</u>
<u>Post-Installation</u>			
--Technical Consultation	<u>EC01</u>	<u>8 hrs.</u>	___ <u>X</u>

The support service specified here is Entitled Support to be delivered within 90 days of installation in accordance with Wang Policy and is provided at no additional charge with the equipment procurement. If support services not specified here are requested, the service may be provided in accordance with Wang Policies and at Wang's per call rates and terms then in effect.

NOTE: All orders for add-ons and upgrade equipment MUST include the work order numbers and serial numbers of the system components involved.



SOFTWARE  
ENTITLED SUPPORT SERVICES SUMMARY

SUPPORT DESCRIPTION	Activity Codes	Support Hours Up to-	Site Loc. Wang/Cust	Class Training Up to-	# of Class Attendees at No Charge
ATMS/WPS					
Pro-Installation Meeting	EP01	2 hrs.	X		
Technical Consultation	EC01	6 hrs.	X		
2200/WP					
Technical Consultation	EC01	4 hrs.	X		
VISUAL MEMORY					
Class Training	ET06		X	8 Hours	2 Operators
Technical Consultation	EC01	6 hrs.	X		
Pre-Installation Meeting	EP01	6 hrs.	X		
TIME MANAGEMENT					
Class Training	ET07		X	4 Hours	2 Operators
Technical Consultation	EC01	3 hrs.	X		
VOICE DOCUMENT					
Class Training	ET08		X	4 Hours	2 Operators
Technical Consultation	EC01	3 hrs.	X		
VS/WP					
Pre-Installation Meeting	EP01	2 hrs.	X		
Basic Word Processing Training	ET01		X	16 Hours	2 Operators*
Mathpak Training	ET05		X	4 Hours	1 Operator
Glossary Training	ET09		X	4 Hours	1 Operator
Technical Consultation	EC01	2 hrs.	X		

ENTITLEMENT DOCUMENTATION: For each of the above software products purchased by the customer, Wang will provide one complete set of user reference and/or training documentation per system.

The support service specified here is Entitled Support to be delivered within 90 days of installation in accordance with Wang Policy and is provided at no additional charge with the software procurement. If support services not specified here are requested, the service may be provided in accordance with Wang Policies and at Wang's per call rates and terms then in effect.

\* The customer is entitled to Basic Word Processing training for one operator for every ten workstations procured with the initial system order. This does not apply when Professional Computers are purchased to serve as terminals on the host.

NOTE: All orders for add-ons and upgrade equipment MUST include the work order numbers and serial numbers of the system components involved.

TELECOMMUNICATIONS PROTOCOLS  
ENTITLED SUPPORT SERVICES SUMMARY

<u>SUPPORT DESCRIPTION</u>	<u>Activity Codes</u>	<u>Support Hours Up to-</u>	<u>Site Loc. Wang/Cust</u>
<u>Technical Consultation</u>			
--for Emulator Products	<u>EC01</u>	<u>4 hrs.</u>	<u>    X</u>
--for Networking Products	<u>EC01</u>	<u>6 hrs.</u>	<u>    X</u>

## STANDARD NETWORKING PRODUCTS\*

ASYNCHRONOUS PROTOCOLS

Teletype Emulation (TTY/TTE)  
2741  
3741  
RCM (2200)  
BURROUGHS TC 500/700

BISYNCHRONOUS PROTOCOLS

2780/3780/WPS, VSCOPY  
HASP (IBM 360/20)  
U 100/200 (UNIVAC)  
UT 200 (COC)  
2200-2200

## STANDARD NETWORKING PRODUCTS\*

3270 Bisynch products  
3270 SNA/SDLC products  
3777 SNA/SDLC  
X.21 (Packet Switching)  
X.25 (Packet Switching)  
Teletex

WANG

COMPANY CONFIDENTIAL

\*Note: All telecommunications products, as they relate to the Professional Computer, are supported under the generic "Professional Computer Support Policy". No Entitled Support hours are provided.

ENTITLED SUPPORT SERVICES DOCUMENTATION: Wang will provide one complete set of user reference documentation for user reference for each product.

The support service specified here is Entitled Support to be delivered within 90 days of installation in accordance with Wang Policy and is provided at no additional charge with the equipment procurement. If support services not specified here are requested, the service may be provided in accordance with Wang Policies and at Wang's per call rates and terms then in effect.

NOTE: All orders for add-ons and upgrade equipment MUST include the work order numbers and serial numbers of the system components involved.

WP PLUS  
ENTITLED SUPPORT SERVICES SUMMARY

<u>SUPPORT DESCRIPTION</u>	<u>Activity Codes</u>	<u>Support Hours Up to-</u>	<u>Site Loc. Wang/Cust</u>	<u>Class Training Up to-</u>	<u># of Class Attendees at No Charge</u>
<u>Pre-Installation</u>					
— Orientation Seminar	<u>ET02</u>	<u>4 hrs.</u>	<u>X X</u>	—	<u>1 Contact</u>
<u>Installation</u>					
— Consultation	<u>FI01</u>	<u>2 hrs.</u>	— <u>X</u>	—	—
<u>Post-Installation</u>					
— System Administration	<u>ET01</u>	—	<u>X</u> —	<u>8 Hours</u>	<u>1 Contact</u>

WANG

COMPANY CONFIDENTIAL

ENTITLED SUPPORT SERVICES DOCUMENTATION: Wang will provide one complete set of user reference documentation per system.

The support service specified here is Entitled Support to be delivered within 90 days of installation in accordance with Wang Policy and is provided at no additional charge with the equipment procurement. If support services not specified here are requested, the service may be provided in accordance with Wang Policies and at Wang's per call rates and terms then in effect.

NOTE: All orders for add-ons and upgrade equipment MUST include the work order numbers and serial numbers of the system components involved.

Charter Business Graphics  
ENTITLED SUPPORT SERVICES SUMMARY

<u>SUPPORT DESCRIPTION</u>	<u>Activity Codes</u>	<u>Support Hours Up to-</u>	<u>Site Loc. Wang/Cust</u>	<u>Class Training Up to-</u>	<u># of Class Attendees at No Charge</u>
<u>Installation</u>					
Seminar	<u>E101</u>	<u>2 hrs.</u>	<u>X X</u>		<u>1 Contact</u>

WANG

COMPANY CONFIDENTIAL

ENTITLED SUPPORT SERVICES DOCUMENTATION: Wang will provide one complete set of user reference documentation per system.

The support service specified here is Entitled Support to be delivered within 90 days of installation in accordance with Wang Policy and is provided at no additional charge with the equipment procurement. If support services not specified here are requested, the service may be provided in accordance with Wang Policies and at Wang's per call rates and terms then in effect.

NOTE: All orders for add-ons and upgrade equipment MUST include the work order numbers and serial numbers of the system components involved.

COMPANY CONFIDENTIAL

Effective Date: MAY 1, 1984

-Prices and equipment availability subject to change without notice-

2200 PRODUCT LINE PRICE LIST

TABLE OF CONTENTS

DESCRIPTION	PAGE	EFFECTIVE DATE
CENTRAL PROCESSING UNITS		
2200SVP	2	05/01/84
2200LVP	3	05/01/84
2200LVPC	4	05/01/84
2200HVP Packaged Systems	6	05/01/84
2200HVP	6	05/01/84
2200HVPC	6	05/01/84
MEMORY UPGRADES	7	05/01/84
WORKSTATIONS	9	05/01/84
CONTROLLERS	10	05/01/84
SYSTEM SOFTWARE	10	05/01/84
PRINTERS		
Output Peripherals	11	05/01/84
Controllers	11	05/01/84
Options	12	05/01/84
MASS STORAGE PERIPHERALS		
Tape Drives	13	05/01/84
Diskette Drives	13	05/01/84
Disk Drive Units	14	05/01/84
DISK AND DISKETTE CONTROLLERS		
2270 and 2270A Series	14	05/01/84
2280 Series	14	05/01/84
2275	14	05/01/84
DATA COMMUNICATIONS		
Controllers - B/C Series	15	05/01/84
Software - B/C Series	15	05/01/84
Controllers - D Series	17	05/01/84
Software - D Series/ICS Utilities	17	05/01/84
Software - D Series	19	05/01/84
MISC. TELECOMMUNICATIONS EQUIPMENT	19	05/01/84
2200 UPGRADES	20	05/01/84
CONFIGURATION GUIDES	28	05/01/84
ENTITLEMENT SUMMARY	32	05/01/84

**INSTALLATION CHARGE**

There is no installation charge for initial installation of system(s). For add-on equipment or upgrade, that is not designated customer-installable there is an installation charge of 3% of the purchase price - minimum charge \$100 per order.

**NOTE:** All orders for add-ons and upgrade equipment **MUST** include the work order numbers and serial numbers of the system components involved.

WANG

COMPANY CONFIDENTIAL

MODEL  
NUMBER

DESCRIPTION

PURCHASE  
PRICE

MONTHLY  
MAINTENANCE

-----MONTHLY RENTAL PRICES-----  
1 YEAR 2 YEAR 3 YEAR 5 YEAR

2200SVP CENTRAL PROCESSING UNITS

All 2200SVP CPUs include a 1 MB DSDD Industry Compatible Diskette Drive. User Memory is available in a 32, 64 or 128K sizes. Optional Mass Storage is available in the form of an additional 1 MB DSDD Diskette or a 2, 4 or 8MB Fixed Disk Drive.

MODEL NUMBER	DESCRIPTION	PURCHASE PRICE	MONTHLY MAINTENANCE	1 YEAR	2 YEAR	3 YEAR	5 YEAR
2200SVP-8X	32K Memory, 1MB DSDD Industry Compatible Diskette	\$ 4,600	\$ 68	\$ 257	\$ 230	\$ 198	180
2200SVP-8A	32K Memory, Dual 1MB DSDD Industry Compatible Diskette	5,700	82	325	291	251	228
2200SVP-8B	32K Memory, 1MB DSDD Industry Compatible Diskette and 2MB Fixed Disk	6,700	98	382	342	295	268
2200SVP-8C	32K Memory, 1MB DSDD Industry Compatible Diskette and 4MB Fixed Disk	7,500	110	420	375	330	300
2200SVP-8D	32K Memory, 1MB DSDD Industry Compatible Diskette and 8MB Fixed Disk	9,000	125	504	450	396	360
2200SVP-16X	64K Memory, 1MB DSDD Industry Compatible Diskette	5,700	78	325	291	251	228
2200SVP-16A	64K Memory, Dual 1MB DSDD Industry Compatible Diskette	6,900	92	394	352	304	276
2200SVP-16B	64K Memory, 1MB DSDD Industry Compatible Diskette and 2MB Fixed Disk	7,900	108	443	395	348	316
2200SVP-16C	64K Memory, 1MB DSDD Industry Compatible Diskette and 4MB Fixed Disk	8,700	120	488	435	383	348
2200SVP-16D	64K Memory, 1MB DSDD Industry Compatible Diskette and 8MB Fixed Disk	10,200	135	561	500	449	408
2200SVP-32X	128K Memory, 1MB DSDD Industry Compatible Diskette	6,900	93	394	352	304	276
2200SVP-32A	128K Memory, Dual 1MB DSDD Industry Compatible Diskette	8,100	107	454	405	357	324
2200SVP-32B	128K Memory, 1MB DSDD Industry Compatible Diskette and 2MB Fixed Disk	9,100	123	510	455	401	364

NOTE: All orders for add-ons and upgrade equipment MUST include the work order numbers and serial numbers of the system components involved.



MODEL NUMBER	DESCRIPTION	PURCHASE PRICE	MONTHLY MAINTENANCE	-----MONTHLY RENTAL PRICES-----			
				1 YEAR	2 YEAR	3 YEAR	5 YEAR
<u>2200SVP CENTRAL PROCESSING UNITS (continued)</u>							
2200SVP-32C	128K Memory, 1MB DSDD Industry Compatible Diskette and 4MB Fixed Disk	\$ 9,900	\$ 135	\$ 555	\$ 495	\$ 436	396
2200SVP-32D	128K Memory, 1MB DSDD Industry Compatible Diskette and 8MB Fixed Disk	11,400	150	627	559	502	456
SVP OPTION-W	Allows attachment of 2nd and/or 3rd workstation to multi-processing SVP.	750	N/A	51	39	37	33
<u>2200LVP CENTRAL PROCESSING UNITS</u>							
All 2200LVP CPUs include a a 3 I/O Slot Chassis and a 1MB Industry Compatible DSDD Diskette Drive. User memory is available in 32, 64, 128 and 256K sizes. Fixed Disk options of 2, 4, and 8 MB are available.							
2200LVP-8X	32K Memory, 1MB Diskette	\$ 7,600	\$ 80	\$ 426	\$ 380	\$ 335	304
2200LVP-8B	32K Memory, 1MB Diskette and 2MB Fixed Disk	9,800	110	549	490	432	392
2200LVP-8C	32K Memory, 1MB Diskette and 4MB Fixed Disk	10,600	122	583	520	467	424
2200LVP-8D	32K Memory, 1MB Diskette and 8MB Fixed Disk	12,100	137	666	593	533	484
2200LVP-16X	64K Memory, 1MB Diskette	8,800	108	493	440	388	352
2200LVP-16B	64K Memory, 1MB Diskette and 2MB Fixed Disk	11,000	138	605	539	484	440
2200LVP-16C	64K Memory, 1MB Diskette and 4MB Fixed Disk	11,800	150	649	579	520	472
2200LVP-16D	64K Memory, 1MB Diskette and 8MB Fixed Disk	13,300	165	732	652	586	532
2200LVP-32X	128K Memory, 1MB Diskette	10,000	170	560	500	440	400
2200LVP-32B	128K Memory, 1MB Diskette and 2MB Fixed Disk	12,200	200	671	598	537	488
2200LVP-32C	128K Memory, 1MB Diskette and 4MB Fixed Disk	13,000	212	715	637	572	520
2200LVP-32D	128K Memory, 1MB Diskette and 8MB Fixed Disk	14,500	227	798	711	638	580

NOTE: All orders for add-ons and upgrade equipment MUST include the work order numbers and serial numbers of the system components involved.



MODEL NUMBER	DESCRIPTION	PURCHASE PRICE	MONTHLY MAINTENANCE	-----MONTHLY RENTAL PRICES-----			
				1 YEAR	2 YEAR	3 YEAR	5 YEAR

2200LVP CENTRAL PROCESSING UNITS (continued)

2200LVP-64X	256K Memory, 1MB Diskette	\$ 12,400	\$ 267	\$ 682	\$ 608	\$ 546	996
2200LVP-64B	256K Memory, 1MB Diskette and 2MB Fixed Disk	14,600	297	803	716	643	584
2200LVP-64C	256K Memory, 1MB Diskette and 4MB Fixed Disk	15,400	309	847	755	678	616
2200LVP-64D	256K Memory, 1MB Diskette and 8MB Fixed Disk	16,900	324	930	829	744	676

2200LVC CENTRAL PROCESSING UNITS

All 2200LVC CPUs include a 7 I/O Slot Chassis and a single 1MB Industry Compatible DSDD Diskette Drive. Fixed disks are available in 2, 4, 8, 16 or 32 MB sizes. These CPU's are equipped with Expanded Language Option. User Memory is available in 64, 128, 256, 384, and 512K sizes.

2200LVC-16X	64K Memory, 1MB Diskette	\$ 9,300	\$ 124	\$ 521	\$ 465	\$ 410	372
2200LVC-16B	64K Memory, 1MB Diskette and 2MB Fixed Disk	11,500	154	633	564	506	460
2200LVC-16C	64K Memory, 1MB Diskette and 4MB Fixed Disk	12,300	166	677	603	542	492
2200LVC-16D	64K Memory, 1MB Diskette and 8MB Fixed Disk	13,800	181	759	677	608	552
2200LVC-16E	64K Memory, 1MB Diskette and 16MB Fixed Disk	15,800	183	869	775	696	632
2200LVC-16F	64K Memory, 1MB Diskette and 32MB Fixed Disk	17,800	186	979	873	784	712
2200LVC-32X	128K Memory, 1MB Diskette	10,500	139	578	515	462	420
2200LVC-32B	128K Memory, 1MB Diskette and 2MB Fixed Disk	12,700	169	699	623	559	508
2200LVC-32C	128K Memory, 1MB Diskette and 4MB Fixed Disk	13,500	181	743	662	594	540
2200LVC-32D	128K Memory, 1MB Diskette and 8MB Fixed Disk	15,000	196	825	735	660	600
2200LVC-32E	128K Memory, 1MB Diskette and 16MB Fixed Disk	17,000	198	935	833	748	680
2200LVC-32F	128K Memory, 1MB Diskette and 32MB Fixed Disk	19,000	201	1,045	931	836	760

NOTE: All orders for add-ons and upgrade equipment MUST include the work order numbers and serial numbers of the system components involved.

2200/ 2 - 4

COMPANY CONFIDENTIAL  
REPLACES: 02/01/84  
EFFECTIVE: 05/01/84

2200



MODEL NUMBER	DESCRIPTION	PURCHASE PRICE	MONTHLY MAINTENANCE	-----MONTHLY RENTAL PRICES-----			
				1 YEAR	2 YEAR	3 YEAR	5 YEAR
<u>2200LVPC CENTRAL PROCESSING UNITS (continued)</u>							
2200LVPC-64X	256K Memory, 1MB Diskette	\$ 12,900	\$ 169	\$ 710	\$ 633	\$ 568	516
2200LVPC-64B	256K Memory, 1MB Diskette and 2MB Fixed Disk	15,100	199	831	740	665	604
2200LVPC-64C	256K Memory, 1MB Diskette and 4MB Fixed Disk	15,900	211	875	780	700	636
2200LVPC-64D	256K Memory, 1MB Diskette and 8MB Fixed Disk	17,400	226	957	853	766	696
2200LVPC-64E	256K Memory, 1MB Diskette and 16MB Fixed Disk	19,400	228	1,067	951	854	776
2200LVPC-64F	256K Memory, 1MB Diskette and 32MB Fixed Disk	21,400	231	1,177	1,049	942	856
2200LVPC-96X	384K Memory, 1MB Diskette	15,300	195	842	750	674	612
2200LVPC-96C	384K Memory, 1MB Diskette and 4MB Fixed Disk	18,300	241	1,007	897	806	732
2200LVPC-96D	384K Memory, 1MB Diskette and 8MB Fixed Disk	19,800	256	1,089	971	872	792
2200LVPC-96E	384K Memory, 1MB Diskette and 16MB Fixed Disk	21,800	258	1,199	1,069	960	872
2200LVPC-96F	384K Memory, 1MB Diskette and 32MB Fixed Disk	23,800	261	1,309	1,167	1,048	952
2200LVPC-128X	512K Memory, 1MB Diskette	17,700	229	974	868	779	708
2200LVPC-128C	512K Memory, 1MB Diskette and 4MB Fixed Disk	20,700	271	1,139	1,015	911	828
2200LVPC-128D	512K Memory, 1MB Diskette and 8MB Fixed Disk	22,200	286	1,221	1,088	977	888
2200LVPC-128E	512K Memory, 1MB Diskette and 16MB Fixed Disk	24,200	288	1,331	1,186	1,065	968
2200LVPC-128F	512K Memory, 1MB Diskette and 32MB Fixed Disk	26,200	291	1,441	1,284	1,153	1,048

NOTE: All orders for add-ons and upgrade equipment MUST include the work order numbers and serial numbers of the system components involved.

MODEL NUMBER	DESCRIPTION	PURCHASE PRICE	MONTHLY MAINTENANCE	MONTHLY RENTAL PRICES			
				1 YEAR	2 YEAR	3 YEAR	5 YEAR
<u>2200MVP PACKAGED SYSTEMS</u>							
MVP-P1	MVP Processor with 8 available I/O Slots, 64KB Memory, 22C32 Triple Controller, 5 1/4" Disk Storage Device with 10MB Fixed Storage and 320KB Removable Floppy Drive	\$ 7,525	\$ 161	N/A	N/A	N/A	N/A
MVP-P2	MVP Processor with 8 available I/O Slots, 128KB Memory, 22C32 Triple Controller, 5 1/4" Disk Storage Device with 10MB Fixed Storage and 320KB Removable Floppy Drive	8,725	176	N/A	N/A	N/A	N/A
MVP-P3	MVP Processor with 8 available I/O Slots, 256KB Memory, 22C32 Triple Controller, 5 1/4" Disk Storage Device with 10MB Fixed Storage and 320KB Removable Floppy Drive	11,125	206	N/A	N/A	N/A	N/A
MVP-P4	MVP Processor with 6 available I/O Slots, 128KB Memory, 22C32 Triple Controller, 5 1/4" Disk Storage Device with 30MB Fixed Storage and 320KB Removable Floppy Drive	18,000	247	N/A	N/A	N/A	N/A
MVP-P5	MVP Processor with 6 available I/O Slots, 256KB Memory, 22C32 Triple Controller, 5 1/4" Disk Storage Device with 30MB Fixed Storage and 320KB Removable Floppy Drive	19,000	277	N/A	N/A	N/A	N/A

2200MVP CENTRAL PROCESSING UNITS

All MVP CPU's are shipped with a standard 9 I/O Extended Chassis.

2200MVP-8	32K Memory	\$ 4,300	\$ 87	\$ 255	\$ 220	\$ 211	\$ 190
2200MVP-16	64K Memory	5,500	117	317	281	270	242
2200MVP-32	128K Memory	6,700	183	382	342	295	268
2200MVP-64	256K Memory	9,100	287	510	455	401	364

2200MVP-C CENTRAL PROCESSING UNITS

All MVP-C CPU's are equipped with a 7 I/O Slot Extended Chassis and an Expanded Language Option

2200MVP-C-16	64K Memory	\$ 6,000	\$ 100	\$ 342	\$ 306	\$ 264	\$ 240
2200MVP-C-32	128K Memory	7,200	115	404	360	317	288

NOTE: All orders for add-ons and upgrade equipment MUST include the work order numbers and serial numbers of the system components involved.



MODEL NUMBER	DESCRIPTION	PURCHASE PRICE	MONTHLY MAINTENANCE	-----MONTHLY RENTAL PRICES-----			
				1 YEAR	2 YEAR	3 YEAR	5 YEAR
<u>2200MVP CENTRAL PROCESSING UNITS (continued)</u>							
2200MVP-64	256K Memory	\$ 9,600	\$ 145	\$ 538	\$ 480	\$ 423	\$ 384
2200MVP-96	384K Memory	12,000	175	660	588	528	480
2200MVP-128	512K Memory	14,400	205	792	706	634	576

UPGRADE JOB #	DESCRIPTION	PURCHASE PRICE
---------------	-------------	----------------

The purchase charges listed include any applicable difference in prices. For purchase systems the incremental maintenance charge is also due.

ADDITIONAL MEMORY

UPGRADES TO 384K AND 512K-MEMORY REQUIRE THAT THE CPU BE EQUIPPED WITH A MVP/LVP C-OPTION.

V1632	16K to 32K Memory Upgrade (VP, MVP)	\$ 1,000
V1664	16K to 64K Memory Upgrade (VP, MVP)	1,500
V16128	16K to 128K Memory Upgrade (MVP)	2,400
V16256	16K to 256K Memory Upgrade (MVP)	4,800
V16384	16K to 384K Memory Upgrade (MVP)	7,200
V16512	16K to 512K Memory Upgrade (MVP)	9,600
V3264	32K to 64K Memory Upgrade (SVP, VP, LVP, MVP)	1,200
V32128	32K to 128K Memory Upgrade (SVP, LVP, MVP)	2,400
V32256	32K to 256K Memory Upgrade (MVP, LVP)	4,800
V32384	32K to 384K Memory Upgrade (MVP, LVP)	7,200
V32512	32K to 512K Memory Upgrade (MVP, LVP)	9,600

NOTE: All orders for add-ons and upgrade equipment MUST include the work order numbers and serial numbers of the system components involved.

UPGRADE  
JOB #

DESCRIPTION

PURCHASE  
PRICE

The purchase charges listed include any applicable difference in prices. For purchase systems the incremental maintenance charge is also due.

ADDITIONAL MEMORY (continued)

UPGRADES TO 384K AND 512K MEMORY REQUIRE THAT THE CPU BE EQUIPPED WITH A MVP/LVP C-OPTION.

V4864	48K to 64K Memory Upgrade (VP, MVP)	\$ 1,600
V48128	48K to 128K Memory Upgrade (MVP)	2,400
V48256	48K to 256K Memory Upgrade (MVP)	4,800
V48384	48K to 384K Memory Upgrade (MVP)	7,200
V48512	48K to 512K Memory Upgrade (MVP)	9,600
V64128	64K to 128K Memory Upgrade (MVP, LVP, MVP-P1 to MVP-P2)	1,200
V64256	64K to 256K Memory Upgrade (MVP, LVP, MVP-P1 to MVP-P3)	3,600
V64384	64K to 384K Memory Upgrade (MVP, LVP)	6,000
V64512	64K to 512K Memory Upgrade (MVP, LVP)	8,400
V96128	96K to 128K Memory Upgrade (MVP)	1,000
V96256	96K to 256K Memory Upgrade (MVP)	3,400
V96384	96K to 384K Memory Upgrade (MVP)	5,800
V96512	96K to 512K Memory Upgrade (MVP)	8,200
V128256	128K to 256K Memory Upgrade (MVP, LVP, MVP-P2 to MVP-3P, MPV-P4 to MVP-P5)	2,400
V128384	128K to 384K Memory Upgrade (MVP, LVP)	4,800

NOTE: All orders for add-ons and upgrade equipment MUST include the work order numbers and serial numbers of the system components involved.

2200/ 2 - 8

COMPANY CONFIDENTIAL  
REPLACES: 02/01/84  
EFFECTIVE: 05/01/84

2200

UPGRADE JOB #	DESCRIPTION	PURCHASE PRICE
------------------	-------------	-------------------

The purchase charges listed include any applicable difference in prices. For purchase systems the incremental maintenance charge is also due.

**ADDITIONAL MEMORY (continued)**

UPGRADES TO 384K AND 512K MEMORY REQUIRE THAT THE CPU BE EQUIPPED WITH A MVP/LVP C-OPTION.

V128512	128K to 512K Memory Upgrade (MVP, LVP)	\$ 7,200
V192256	192K to 256K Memory Upgrade (MVP)	1,500
V192384	192K to 384K Memory Upgrade (MVP)	3,900
V192512	192K to 512K Memory Upgrade (MVP)	6,300
V256384	256K to 384K Memory Upgrade (MVP, LVP)	2,400
V256512	256K to 512K Memory Upgrade (MVP, LVP)	4,800
V384512	384K to 512K Memory Upgrade (MVP, LVP)	2,400

MODEL NUMBER	DESCRIPTION	PURCHASE PRICE	MONTHLY MAINTENANCE	MONTHLY RENTAL PRICES			
				1 YEAR	2 YEAR	3 YEAR	5 YEAR
<b>WORKSTATIONS</b>							
2336DE	Interactive DP Ergonomic Style Workstation	\$ 2,100	\$ 22	\$ 114	\$ 102	\$ 88	80
2336DM	Integrated DP/MP Ergonomic Workstation (requires 195-2174 -3 or 195-2174-S for 2200/MP Word Processing Software Sys- tem)	2,100	22	114	102	88	80
2326DM	Integrated DP/MP Workstation with Expanded Keyboard	2,100	22	114	102	88	80

NOTE: All orders for add-ons and upgrade equipment MUST include the work order numbers and serial numbers of the system components involved.

MODEL NUMBER	DESCRIPTION	PURCHASE PRICE	MONTHLY MAINTENANCE	-----MONTHLY RENTAL PRICES-----			
				1 YEAR	2 YEAR	3 YEAR	5 YEAR
<u>CONTROLLERS</u>							
2236MXD	4-Port Terminal Multiplexer for 2236DE/DW and 2236DE/DW	\$ 1,200	\$ 10	\$ 62	\$ 56	\$ 53	48
2236MXE	4 Port Terminal Processor with Asynchronous Communications capability. Supports 2236DE/DW and 2336DE/DW	1,400	10	72	65	62	56
22C32	Triple Controller for Diskette Printer and one 2236DE or 2236DW	1,000	5	51	46	44	40

NOTE: Maximum of 2236MXD, 2236MXE, 2236DE, 2236DW or 2336DW or 22C32 are as follows:

	VP	SVP	LVP	MVP
2236DE or 2236DW	1	3	13	13
2236DW	1	3	13	13
2236MXD	1	0	3	3
2236MXE	1	0	3	3
22C32	1	0	1	1

MODEL NUMBER	DESCRIPTION	INITIAL LICENSE FEE	MONTHLY LICENSE FEE	-----MONTHLY RENTAL PRICES-----			
				1 YEAR	2 YEAR	3 YEAR	5 YEAR
<u>SYSTEM SOFTWARE</u>							
195-2174-3	2200 Word Processing Software (VP, MVP)	\$ 2,000	N/A	N/A	N/A	N/A	N/A
195-2174-5	2200 Word Processing Software (SVP, LVP)	2,000	N/A	N/A	N/A	N/A	N/A
195-2208-3	DATAMERGE (VP, MVP, MVPC)	250	N/A	N/A	N/A	N/A	N/A
195-2208-5	DATAMERGE (SVP, LVP, LVPC)	250	N/A	N/A	N/A	N/A	N/A
195-2115-3	IDEAS Release 1 (VP, MVP, MVPC)	1,000	N/A	N/A	N/A	N/A	N/A
195-2115-5	IDEAS Release 1 (SVP, LVP, LVPC)	1,000	N/A	N/A	N/A	N/A	N/A
195-2209-3	IDEAS Release 2 (VP, MVP, MVPC)	1,500	N/A	N/A	N/A	N/A	N/A
195-2209-5	IDEAS Release 2 (SVP, LVP, LVPC)	1,500	N/A	N/A	N/A	N/A	N/A
195-2217-3	WANG P.R.I.S.M. (VP, MVP, MVPC)	1,500	N/A	N/A	N/A	N/A	N/A
195-2217-5	WANG P.R.I.S.M. (SVP, LVP, LVPC)	1,500	N/A	N/A	N/A	N/A	N/A

NOTE: All orders for add-ons and upgrade equipment MUST include the work order numbers and serial numbers of the system components involved.



MODEL NUMBER	DESCRIPTION	PURCHASE PRICE	MONTHLY MAINTENANCE	-----MONTHLY RENTAL PRICES-----			
				1 YEAR	2 YEAR	3 YEAR	5 YEAR
<u>OUTPUT PERIPHERALS</u>							
All printers must be attached to either the 22C02 controller, directly to any "D", "DE", or "DM" type interactive workstation, to the 22C11 Dual Controller (Printer and Diskette) or the 22C32 Triple Controller.							
2211H	Printer Multiplexer (max. 4 CPU and 1 Printer)	\$ 1,000	\$ 15	\$ 51	\$ 46	\$ 44	40
2231W-3	Graphic Matrix Printer, 2282 Graphic CRT Accessory	3,800	39	194	175	168	152
2231W-6	Hi-density Matrix Line Printer (132 Col 70 CPS)	3,300	39	169	152	146	132
2233	Bidirectional Matrix Printer 120/100 CPS 10/12.2 Pitch	2,500	35	128	115	110	100
2235	Bidirectional Matrix Printer 180/222 CPS 10/12.2 Pitch	3,500	48	179	161	154	140
2245	80 CPS Matrix Printer	1,000	15	51	46	44	40
2273-1	Low Speed Band Printer with 1 Utility B Print Band. See General Information Section of VS Price List for Print Band Alternatives.	8,500	96	434	391	374	340
2273-2	Medium Speed Band Printer with 1 Utility C Print Band. See General Information Section of VS Price List for Print Band Alternatives.	12,000	137	612	552	528	480
2281W	Wang Daisy Printer/Plotter (30 CPS)	4,500	49	230	207	198	180
2281WC	Wide Carriage Daisy Printer/Plotter (30CPS)	6,000	49	306	276	264	240
DM/22-20	Bidirectional Daisy Wheel Printer (20 CPS)	2,695	37	138	124	119	108
<u>PRINTER CONTROLLERS</u>							
22C02	Printer/Drum Plotter Controller	\$ 200	\$ 3	\$ 11	\$ 10	\$ 9	8
22C11	Dual Controller for Printer and Diskette	300	4	16	14	14	12

NOTE: All orders for add-ons and upgrade equipment MUST include the work order numbers and serial numbers of the system components involved.



MODEL NUMBER	DESCRIPTION	PURCHASE PRICE	MONTHLY MAINTENANCE	-----MONTHLY RENTAL PRICES-----			
				1 YEAR	2 YEAR	3 YEAR	5 YEAR

PRINTER OPTIONS

FT-2	Mono-Directional Forms Tractor for DW-20	\$ 250	N/A	N/A	N/A	N/A	N/A
OP-124	Mono-Directional Forms Tractor for 2281WC	250	N/A	N/A	N/A	N/A	N/A
BFT-1	Bidirectional Forms Tractor for 2281W, 5541W, 5577, 6581W and DW/22-20	300	N/A	N/A	N/A	N/A	N/A
BFT-2	Bidirectional Forms Tractor for 2281WC, 5541WC and 6581WC	300	N/A	N/A	N/A	N/A	N/A

TWIN SHEET FEEDERS

The following Twin Sheet Feeders use paper sizes:  
8 1/2" x 11" to 8 1/2" x 14" or  
21.59cm x 27.94cm to 21.59cm to 35.56cm

TSF-20	Twin Sheet Feeder for 2281W	\$ 2,000	\$ 21	\$ 102	\$ 92	\$ 88	\$ 80
TSF-22	Twin Sheet Feeder for 2281WC	2,000	21	102	92	88	80
TSF-51	Twin Sheet Feeder for DW/OS-20 DW/22-20	2,000	21	110	102	88	80

The following Twin Sheet Feeders for Int'l use paper sizes:  
8 1/4" x 11 3/4" to 8 1/4" x 14" or  
20.95cm x 29.70cm to 20.95cm to 35.56cm

TSF-21	Twin Sheet Feeder for 2281W	\$ 2,000	\$ 21	\$ 102	\$ 92	\$ 88	\$ 80
TSF-23	Twin Sheet Feeder for 2281WC	2,000	21	102	92	88	80
TSF-53	Twin Sheet Feeder for DW/OS-20 DW/22-20	2,000	21	110	102	88	80

ENVELOPE FEEDERS

EF-11	Envelope Feeder for 2281W 115 VAC 60hz (U.S. sized business envelopes; #7 3/4, 9, 10)	\$ 2,000	\$ 33	\$ 102	\$ 92	\$ 88	\$ 80
EF-21	Envelope Feeder for DW-20 Printer. 115 VAC 60hz (U.S. sized business envelopes; #7 3/4, 9, 10)	2,000	33	110	102	88	80

NOTE: All orders for add-ons and upgrade equipment MUST include the work order numbers and serial numbers of the system components involved.



MODEL NUMBER	DESCRIPTION	PURCHASE PRICE	MONTHLY MAINTENANCE	-----MONTHLY RENTAL PRICES-----			
				1 YEAR	2 YEAR	3 YEAR	5 YEAR

## ENVELOPE FEEDERS (continued)

EF-12	Envelope Feeder for 2281W 220 VAC 50hz (U.S. sized business envelopes; #7 3/4, 9, 10)	\$ 2,000	\$ 33	\$ 102	\$ 92	\$ 88	\$ 80
EF-22	Envelope Feeder for DM-20 Printer. 220 VAC 50hz (U.S. sized business envelopes; #7 3/4, 9, 10)	2,000	33	110	102	88	80
EF-13	Envelope Feeder for 2281W 220 VAC 50hz (Int'l sized business envelopes; min. 98.4 x 190.5mm max. 108 x 222.4mm)	2,000	33	102	92	88	80
EF-23	Envelope Feeder for DM-20 Printer 220 VAC 50hz (Int'l sized business envelopes; min. 98.4 x 190.5 mm max. 108 x 222.4 mm)	2,000	33	110	102	88	80

## MASS STORAGE PERIPHERALS

## TAPE DRIVES

2209A	1600 BPI 9-Track Tape Drive with Controller	\$ 15,000	\$ 128	\$ 765	\$ 690	\$ 660	\$ 600
2229	Four Track, 6400 BPI, 14 Mega- byte 30 inches per-second Tape Cartridge	4,500	53	230	207	198	180

## DISKETTE DRIVES

Diskette Drive units must be attached to a controller. The controller may be a 22C11 Dual Controller, 22C13 or 22C32 Triple Controller or a 22C03 Diskette Controller.

2270A-1	.25MB Industry Compatible Sin- gle Removable Diskette Drive Only	\$ 3,200	\$ 36	\$ 164	\$ 148	\$ 141	\$ 128
2270A-2	.50MB Industry Compatible Dual Removable Diskette Drive Only	4,700	53	240	217	207	188
2270A-3	.75MB Industry Compatible Tri- ple Removable Diskette Drive Only	6,200	70	317	286	273	248

NOTE: All orders for add-ons and upgrade equipment MUST include the work order numbers and serial numbers of the system components involved.

MODEL NUMBER	DESCRIPTION	PURCHASE PRICE	MONTHLY MAINTENANCE	-----MONTHLY RENTAL PRICES-----			
				1 YEAR	2 YEAR	3 YEAR	5 YEAR
DISK DRIVE UNITS							
2275 Series							
2275-10	10MB 5 1/4" Winchester Drive 320KB Floppy Drive	\$ 3,000	\$ 56	\$ 165	\$ 153	\$ 132	120
2275-20	Dual 10MB 5 1/4" Winchester Drive	4,000	84	220	204	176	160
2275-30	30 MEG 5 1/4" Winchester Drive 320KB Floppy Drive	6,500	65	358	332	286	260
2275-60	Dual 30MB 5 1/4" Winchester Drives	8,500	97	468	434	374	340
2280 Series							
2280-3A	13.4MB Removable and 67MB Fixed Disk Drive (80.4MB Total) with 22C14 Disk Processing Unit	\$ 16,500	\$ 216	\$ 908	\$ 842	\$ 726	660

NOTE: The 2280 disk drive series are available with the high altitude option. When ordering these options, add an "HA" to the end of the model number and \$350 to the purchase price.

#### 2280N Series

The 2280N Series Disk Drive, customer must have 2280 Drive with a 22C14 Controller for connection of 2280N Drive.

2280N-3A	13.4MB Removable and 67MB Fixed Disk Drive (80.4MB Total) Only	\$ 13,000	\$ 186	\$ 715	\$ 663	\$ 572	520
----------	--	-----------	--------	--------	--------	--------	-----

The 2280 Series Disk Drives are not available with MXA-1 and MXB-1

#### DISK AND DISKETTE CONTROLLERS

##### 2270 AND 2270A SERIES

22C03	Diskette Controller	\$ 200	\$ 3	\$ 11	\$ 10	\$ 9	8
-------	---------------------	--------	------	-------	-------	------	---

##### 2280 SERIES

2280MUX	2280 Disk Multiplexing Unit Supports Up to 3 CPUs	\$ 2,000	\$ 20	\$ 102	\$ 92	\$ 88	80
22C80	Disk Multiplexing Controller for VP/LVP/MVP. One required for each CPU interfacing with 2280MUX	500	5	26	23	22	20
22C14	DPU for 2280 Disk Drives	7,000	50	357	322	308	280

NOTE: All orders for add-ons and upgrade equipment MUST include the work order numbers and serial numbers of the system components involved.

MODEL NUMBER	DESCRIPTION	PURCHASE PRICE	MONTHLY MAINTENANCE	-----MONTHLY RENTAL PRICES-----			
				1 YEAR	2 YEAR	3 YEAR	5 YEAR

**DATA COMMUNICATIONS CONTROLLERS - B/C SERIES**

All Communications Controllers require a software package. The necessary software packages are included at no charge unless otherwise noted. (Software Packages with model numbers ending in "-3" are for VP and MVP systems (SSSD media). Model numbers ending in "-5" are for SVP and LVP systems (DSDD media). ALL ORDERS INVOLVING CONTROLLERS SHIPPED WITH SOFTWARE MUST SPECIFY THE MEDIA TYPE (i.e. -5 for DSDD or -3 for SSSD).

2227B	Buffered Asynchronous Communications Controller. Includes 195-2056-3/-5 Software	\$ 750	\$ 17	\$ 39	\$ 35	\$ 33	30
2228B	Communications Controller (8K) Includes 195-2057-3/-5 Software	1,500	17	77	69	66	60
2228C	Communications Controller for IBM 3275 Emulation. Includes 195-2048-3/-5 Software.	1,700	19	87	79	75	68
OP-27B	Buffered Asynchronous Communications Controller for SVP. Includes 195-2056-5 Software	750	19	39	35	33	30
OP-28B	Communications Controller for SVP (8K). Includes 195-2057-5 Software.	1,500	19	77	69	66	60
OP-28C	Communications Controller for SVP for IBM 3275 Emulation. Includes 195-2048-5 Software.	1,700	22	87	79	75	68

MODEL NUMBER	DESCRIPTION	INITIAL LICENSE FEE	MONTHLY LICENSE FEE	-----MONTHLY RENTAL PRICES-----			
				1 YEAR	2 YEAR	3 YEAR	5 YEAR

**DATA COMMUNICATIONS SOFTWARE - B/C SERIES**

The following Software Packages work with the Data Communications Controllers listed above. They Do Not work with 2228D or OP-28D models.

195-0047-3	Burroughs Pol1/Select Communications for use with 2228B, 2228C (VP, MVP)	\$ 100	N/A	N/A	N/A	N/A	N/A
195-0047-5	Burroughs Pol1/Select Communications for use with 2228B, 2228C (LVP), OP-28B, OP-28C (SVP)	100	N/A	N/A	N/A	N/A	N/A
195-2056-3	Asynchronous Communications Software for use with 2227B, 2228B, 2228C (VP, MVP)	100	N/A	N/A	N/A	N/A	N/A

NOTE: All orders for add-ons and upgrade equipment MUST include the work order numbers and serial numbers of the system components involved.

MODEL NUMBER	DESCRIPTION	INITIAL LICENSE FEE	MONTHLY LICENSE FEE	-----MONTHLY RENTAL PRICES-----			
				1 YEAR	2 YEAR	3 YEAR	5 YEAR
<u>DATA COMMUNICATIONS SOFTWARE - B/C SERIES</u> (continued)							
195-2056-5	Asynchronous Communications Software for use with 2227B, 2228B, 2228C (LVP), OP-27B, OP-28B, OP-28C (SVP)	\$ 100	N/A	N/A	N/A	N/A	N/A
195-2057-3	IBM Bisynchronous Batch Protocol for use with 2228B, 2228C (VP, MVP)	100	N/A	N/A	N/A	N/A	N/A
195-2057-5	IBM Bisynchronous Batch Protocol for use with 2228B, 2228C (LVP), OP-28B, OP-28C (SVP)	100	N/A	N/A	N/A	N/A	N/A
195-2168-3	Remote Control and Maintenance Software for use with 2227B, 2228B, 2228C (VP, MVP)	150	N/A	N/A	N/A	N/A	N/A
195-2168-5	Remote Control and Maintenance Software for use with 2227B, 2228B, 2228C (LVP), OP-27B, OP-28B, OP-28C (SVP)	150	N/A	N/A	N/A	N/A	N/A
195-2277-3	UNIVAC Uniscope 100/200 Single Station Emulation for use with 2228B, 2228C (VP, MVP)	1,000	N/A	N/A	N/A	N/A	N/A
195-2277-5	UNIVAC Uniscope 100/200 Single Station Emulation for use with 2228B, 2228C (LVP), OP-28B, OP-28C (SVP)	1,000	N/A	N/A	N/A	N/A	N/A
195-2278-3	CDC UT200 Emulation for use with 2228B, 2228C (VP, MVP)	1,000	N/A	N/A	N/A	N/A	N/A
195-2278-5	CDC UT200 Emulation for use with 2228B, 2228C (LVP), OP-28B, OP-28C (SVP)	1,000	N/A	N/A	N/A	N/A	N/A
195-2297-3	UNIVAC 1004 RMS-1 Batch Emulation for use with 2228B, 2228C (VP, MVP)	1,000	N/A	N/A	N/A	N/A	N/A
195-2297-5	UNIVAC 1004 RMS-1 Batch Emulation for use with 2228B, 2228C (LVP), OP-28B, OP-28C (SVP)	1,000	N/A	N/A	N/A	N/A	N/A

NOTE: All orders for add-ons and upgrade equipment MUST include the work order numbers and serial numbers of the system components involved.



MODEL NUMBER	DESCRIPTION	PURCHASE PRICE	MONTHLY MAINTENANCE	-----MONTHLY RENTAL PRICES-----			
				1 YEAR	2 YEAR	3 YEAR	5 YEAR

DATA COMMUNICATIONS CONTROLLERS - D SERIES

All 2228D and OP-28D Data Communications Controllers require a software package. The necessary software packages are not included and must be purchased separately. (Software packages with model numbers ending in "-3" are for VP and MVP systems (SSSD media). Model numbers ending in "-5" are for SVP and LVP systems (DSDD media). SVP systems must be partitionable models.

2228D-4	Data Communications Controller 64K, RS-232-C/V.24/RS-449 only	\$ 2,000	\$ 30	\$ 102	\$ 92	\$ 88	\$ 80
2228D-4E	Data Communications Controller 64K, RS-232-C/V.24/RS-366/V.25 only	2,000	30	102	92	88	80
2228D-4X	Data Communications Controller 64K, X.21 only	2,000	30	102	92	88	80
2228D-8E	Data Communications Controller 128K, RS-232-C/V.24/RS-366/V.25 only	2,500	30	128	115	110	100
2228D-8X	Data Communications Controller 128K, X.21 only	2,500	30	128	115	110	100
OP-28D-4	Data Communications Controller for SVP 64K, RS-232-C/V.24/RS-449 only	2,000	30	102	92	88	80
OP-28D-4E	Data Communications Controller for SVP 64K, RS-232-C/V.24/RS-366/V.25 only	2,000	30	102	92	88	80
OP-28D-4X	Data Communications Controller for SVP 64K, X.21 only	2,000	30	102	92	88	80
OP-28D-8E	Data Communications Controller for SVP 128K, RS-232-C/V.24/RS-366/V.25 only	2,500	30	128	115	110	100
OP-28D-8X	Data Communications Controller for SVP 128K, X.21 only	2,500	30	128	115	110	100

MODEL NUMBER	DESCRIPTION	INITIAL LICENSE FEE	MONTHLY LICENSE FEE	-----MONTHLY RENTAL PRICES-----			
				1 YEAR	2 YEAR	3 YEAR	5 YEAR

DATA COMMUNICATIONS SOFTWARE - D SERIES/ICS UTILITIES

The Integrated Communications Utilities Software package that immediately follows is a prerequisite for operation of the other software packages in this section (D Series/ICS Utilities)

195-2192-3	Integrated Communications Services (ICS) Utilities (MVP)	\$ 200	N/A	N/A	N/A	N/A	N/A
------------	--	--------	-----	-----	-----	-----	-----

NOTE: All orders for add-ons and upgrade equipment MUST include the work order numbers and serial numbers of the system components involved.

MODEL NUMBER	DESCRIPTION	INITIAL LICENSE FEE	MONTHLY LICENSE FEE	-----MONTHLY RENTAL PRICES-----			
				1 YEAR	2 YEAR	3 YEAR	5 YEAR

DATA COMMUNICATIONS SOFTWARE - D SERIES/ICS UTILITIES (continued)

The Integrated Communications Utilities Software package that immediately follows is a prerequisite for operation of the other software packages in this section (D Series/ICS Utilities)

195-2192-5	Integrated Communications Services (ICS) Utilities (LVP, SVP)	\$ 200	N/A	N/A	N/A	N/A	N/A
------------	---	--------	-----	-----	-----	-----	-----

The following software packages require 64K (2228D-4 and DP-28D-4) Data Communications Controllers. Prerequisite is Integrated Communications Services (ICS) Utilities.

195-2193-3	IBM 2780/3780 Protocols (Includes 2200-2200, WPS Protocol) (MVP)	200	N/A	N/A	N/A	N/A	N/A
195-2193-5	IBM 2780/3780 Protocols (Includes 2200-2200, WPS Protocol) (LVP, SVP)	200	N/A	N/A	N/A	N/A	N/A
2200-MSNT-X25-3	MVP X.25 Transport	500	N/A	N/A	N/A	N/A	N/A
2200-MSNT-X25-5	SVP/LVP X.25 Transport	500	N/A	N/A	N/A	N/A	N/A
2200-MSNT-MS-3	MVP Multipoint Secondary Transport	500	N/A	N/A	N/A	N/A	N/A
2200-MSNT-MS-5	SVP/LVP Multipoint Secondary	500	N/A	N/A	N/A	N/A	N/A
2200-MSNT-PP-3	MVP Point-Point Transport	500	N/A	N/A	N/A	N/A	N/A
2200-MSNT-PP-5	SVP/LVP Point-Point Transport	500	N/A	N/A	N/A	N/A	N/A
2200-MSNS-BSS-3	MVP Basic Support Services	100	N/A	N/A	N/A	N/A	N/A
2200-MSNS-BSS-5	SVP/LVP Basic Support Services	100	N/A	N/A	N/A	N/A	N/A
195-2201-3	Remote TTY (MVP)	200	N/A	N/A	N/A	N/A	N/A
195-2201-5	Remote TTY (LVP, SVP)	200	N/A	N/A	N/A	N/A	N/A

The following software packages require 128K (2228D-8E and DP-28D-8E) Data Communications Controllers. Prerequisite is Integrated Communications Services (ICS) Utilities.

195-2199-3	IBM 3274 Emulation, SNA/SDLC (MVP)	1,250	N/A	N/A	N/A	N/A	N/A
195-2199-5	IBM 3274 Emulation, SNA/SDLC (LVP, SVP)	1,250	N/A	N/A	N/A	N/A	N/A

NOTE: All orders for add-ons and upgrade equipment MUST include the work order numbers and serial numbers of the system components involved.



MODEL NUMBER	DESCRIPTION	INITIAL LICENSE FEE	MONTHLY LICENSE FEE	-----MONTHLY RENTAL PRICES-----			
				1 YEAR	2 YEAR	3 YEAR	5 YEAR

DATA COMMUNICATIONS SOFTWARE - D SERIES

The following software packages require 64K (22280-4 and OP-28D-4) Data Communications Controllers. Does NOT require Intergrated Communications Services (ICS) Utilities.

195-2159-3	3271 BSC Emulation (MVP)	\$ 1,000	N/A	N/A	N/A	N/A	N/A
195-2159-5	3271 BSC Emulation (LVP, SVP)	1,000	N/A	N/A	N/A	N/A	N/A

MODEL NUMBER	DESCRIPTION	PURCHASE PRICE	MONTHLY MAINTENANCE	-----MONTHLY RENTAL PRICES-----			
				1 YEAR	2 YEAR	3 YEAR	5 YEAR

MISCELLANEOUS TELECOMMUNICATIONS EQUIPMENT

2207A	I/O Interface Controller (RS-232-C)	\$ 600	\$ 4	\$ 31	\$ 28	\$ 27	24
2227N	Null Modem	50	N/A	N/A	N/A	N/A	N/A
2228N	Null Modem	50	N/A	N/A	N/A	N/A	N/A
2236LRS	SVP Local/Remote Switch (Not supported on OPTION-W)	150	N/A	N/A	N/A	N/A	N/A

NOTE: All orders for add-ons and upgrade equipment MUST include the work order numbers and serial numbers of the system components involved.



QUANTITY DISCOUNTS FOR WORKSTATION UPGRADES

Discounts are allowed for quantity purchases (sales only; no rentals except as noted on exception basis\*). Orders must be submitted on a single purchase order, delivery may be to multiple delivery points, but must be within six (6) months of initial order. Quantity discounts are applied per model number not on an aggregate basis except as noted on an exception basis. Products for which Wang publishes multi-unit discounts shall receive the higher of the applicable published multi-unit quantity discount, or the Annual Volume Agreement discount, but not both.

\* Quantity discounts for the General Workstation Upgrade Discount apply to both purchase and rental (Single Charge) prices. Discounts apply only to delivery at a single location, not to multiple delivery points.

QUANTITY ORDERED	DISCOUNT
1 - 19	0%
20 - 39	10%
40 +	15%

Computation of the discount for upgrades is calculated on either the full purchase price or the rental single charge. It does not affect the actual rental or maintenance due.

UPGRADE JOB #	DESCRIPTION	PURCHASE PRICE
------------------	-------------	-------------------

The purchase charges listed include any applicable difference in prices. For purchase systems the incremental maintenance charge is also due.

UPGRADES VP/MVP/SVP/LVP

CENTRAL PROCESSING UNITS

UJ-900	VP to MVP CPU Conversion	\$ 1,650
UJ-5026	VP to MVPC	2,200
UJ-5027	MVP to MVPC	1,650
UJ-5028	LVP to LVPC	1,650
UJ-5031	VP/SVP/MVP/LVP Security	440
UJ-5043	Multi-Processing Option (SVP)	1,100

NOTE: All orders for add-ons and upgrade equipment MUST include the work order numbers and serial numbers of the system components involved.

2200/ 2 - 20

COMPANY CONFIDENTIAL  
REPLACES: 02/01/84  
EFFECTIVE: 05/01/84

2200

UPGRADE JOB #	DESCRIPTION	PURCHASE PRICE
------------------	-------------	-------------------

The purchase charges listed include any applicable difference in prices. For purchase systems the incremental maintenance charge is also due.

UPGRADES VP/MVP/SVP/LVP (continued)

CENTRAL PROCESSING UNITS (continued)

The following CPU upgrades include 23360W Workstation, 2236MXD Terminal Controller and 22C02 Printer Controller.

NOTE: When ordering UJ-6009(E) if SVP OPTION-W was included with the returned SVP:  
 A. List Serial Number of the OPTION-W Board (include on contract)  
 B. Deduct \$200 from specified price

UJ-6009	SVP-8X to LVPC-16C (SVP/LVPC) (Upgrade involves an exchange of serialized equipment)	\$ 14,500
UJ-6010	SVP-8A to LVPC-16C (SVP/LVPC) (Upgrade involves an exchange of serialized equipment)	13,300
UJ-6011	SVP-8B to LVPC-16C (SVP/LVPC) (Upgrade involves an exchange of serialized equipment)	12,200
UJ-6012	SVP-8C to LVPC-16C (SVP/LVPC) (Upgrade involves an exchange of serialized equipment)	11,550
UJ-6013	SVP-16X to LVPC-16C (SVP/LVPC) (Upgrade involves an exchange of serialized equipment)	12,900
UJ-6014	SVP-16A to LVPC-16C (SVP/LVPC) (Upgrade involves an exchange of serialized equipment)	12,200
UJ-6015	SVP-16B to LVPC-16C (SVP/LVPC) (Upgrade involves an exchange of serialized equipment)	10,700
UJ-6016	SVP-16C to LVPC-16C (SVP/LVPC) (Upgrade involves an exchange of serialized equipment)	10,100
UJ-6017	SVP-8D to LVPC-16D (SVP/LVPC) (Upgrade involves an exchange of serialized equipment)	10,700
UJ-6018	SVP-16D to LVPC-16D (SVP/LVPC) (Upgrade involves an exchange of serialized equipment)	9,000

CONFIDENTIAL

NOTE: All orders for add-ons and upgrade equipment MUST include the work order numbers and serial numbers of the system components involved.

UPGRADE  
JOB #

DESCRIPTION

PURCHASE  
PRICE

The purchase charges listed include any applicable difference in prices. For purchase systems the incremental maintenance charge is also due.

UPGRADES VP/MVP/SVP/LVP (continued)

CENTRAL PROCESSING UNITS (continued)

The following CPU upgrades include 2336DW Workstation, 2336MXD Terminal Controller and 22C02 Printer Controller.

NOTE: When ordering UJ-6009(E) if SVP OPTION-W was included with the returned SVP:

- A. List Serial Number of the OPTION-W Board (include on contract)
- B. Deduct \$200 from specified price

UJ-6019	SVP-32A to LVPC-32C (SVP/LVPC) (Upgrade involves an exchange of serialized equipment)	\$ 12,650
UJ-6020	SVP-32B to LVPC-32C (SVP/LVPC) (Upgrade involves an exchange of serialized equipment)	9,900
UJ-6021	SVP-32C to LVPC-32C (SVP/LVPC) (Upgrade involves an exchange of serialized equipment)	9,350
UJ-6022	SVP-32D to LVPC-32D (SVP/LVPC) (Upgrade involves an exchange of serialized equipment)	8,800
UJ-6009E	SVP-8X to LVPC-16C (SVP/LVPC) (Upgrade involves an exchange of serialized equipment)	14,500
UJ-6010E	SVP-8A to LVPC-16C (SVP/LVPC) (Upgrade involves an exchange of serialized equipment)	13,300
UJ-6011E	SVP-8B to LVPC-16C (SVP/LVPC) (Upgrade involves an exchange of serialized equipment)	12,200
UJ-6012E	SVP-8C to LVPC-16C (SVP/LVPC) (Upgrade involves an exchange of serialized equipment)	11,500
UJ-6013E	SVP-16X to LVPC-16C (SVP/LVPC) (Upgrade involves an exchange of serialized equipment)	12,900
UJ-6014E	SVP-16A to LVPC-16C (SVP/LVPC) (Upgrade involves an exchange of serialized equipment)	12,200

NOTE: All orders for add-ons and upgrade equipment MUST include the work order numbers and serial numbers of the system components involved.

UPGRADE JOB #	DESCRIPTION	PURCHASE PRICE
------------------	-------------	-------------------

The purchase charges listed include any applicable difference in prices. For purchase systems the incremental maintenance charge is also due.

UPGRADES VP/MVP/SVP/LVP (continued)

CENTRAL PROCESSING UNITS (continued)

The following CPU upgrades include 2336DW Workstation, 2236MXD Terminal Controller and 22C02 Printer Controller.

NOTE: When ordering UJ-6009(E) if SVP OPTION-W was included with the returned SVP:

- A. List Serial Number of the OPTION-W Board (include on Contract)  
B. Deduct \$200 from specified price

UJ-6015E	SVP-16B to LVPC-16C (SVP/LVPC) (Upgrade involves an exchange of serialized equipment)	\$ 10,700
UJ-6016E	SVP-16C to LVPC-16C (SVP/LVPC) (Upgrade involves an exchange of serialized equipment)	10,100
UJ-6017E	SVP-8D to LVPC-16D (SVP/LVPC) (Upgrade involves an exchange of serialized equipment)	10,700
UJ-6018E	SVP-16D to LVPC-16D (SVP/LVPC) (Upgrade involves an exchange of serialized equipment)	9,000
UJ-6019E	SVP-32A to LVPC-32C (SVP/LVPC) (Upgrade involves an exchange of serialized equipment)	12,650
UJ-6020E	SVP-32B to LVPC-32C (SVP/LVPC) (Upgrade involves an exchange of serialized equipment)	9,900
UJ-6021E	SVP-32C to LVPC-32C (SVP/LVPC) (Upgrade involves an exchange of serialized equipment)	9,350
UJ-6022E	SVP-32D to LVPC-32D (SVP/LVPC) (Upgrade involves an exchange of serialized equipment)	8,800

CRT CONSOLES

List serial numbers of all 2236's being converted.

UJ-915	2236MXD BAUD Conversion to 19,200	\$ 220
--------	--------------------------------------	--------

NOTE: All orders for add-ons and upgrade equipment MUST include the work order numbers and serial numbers of the system components involved.

UPGRADE  
JOB #

DESCRIPTION

PURCHASE  
PRICE

The purchase charges listed include any applicable difference in prices. For purchase systems the incremental maintenance charge is also due.

CRT CONSOLES (continued)

List serial numbers of all 2236's being converted.

UJ-5020	2236DE to 2236DW	\$ 770
UJ-5046	Ergo Upgrade DE to DW with Standard Keyboard	990

FIXED DISKS

UPGRADES TO 16MB AND 32MB DISK OPTIONS REQUIRE THAT THE CPU BE EQUIPPED WITH A MVP/LVP C-OPTION.

UJ-5007	SVP-X to SVP-A	\$ 1,925
UJ-5022	SVP-X to SVP-B (2 MB DR)	3,300
UJ-5023	SVP-X to SVP-C (4MB DR)	4,400
UJ-5042	SVP-X to SVP-D (8MB DR)	5,500
UJ-5008	LVP-X to LVP-B (2MB DR)	2,400
UJ-5009	LVP-X to LVP-C (4MB DR)	3,300
UJ-5010	LVP-X to LVP-D (8MB DR)	5,000
UJ-5032	LVP-X to LVP-E (16MB DR)	7,200
UJ-5033	LVP-X to LVP-F (32MB DR)	9,400
UJ-6007	SVP-A to SVP-B (Dual Diskette to 2MB)	3,300
UJ-6008	SVP-A to SVP-C (Dual Diskette to 4MB)	4,400
UJ-5041	SVP-A to SVP-D (Dual Diskette to 8MB)	5,500
UJ-5001	SVP/LVP-B to SVP/LVP-C (2MB to 4MB DR) (Upgrade involves an exchange of serialized equipment)	1,100
UJ-6003	SVP/LVP-B to SVP/LVP-D (2MB to 8MB DR)	2,750
UJ-6005	SVP/LVP-C to SVP/LVP-D (4MB to 8MB DR)	2,750

NOTE: All orders for add-ons and upgrade equipment MUST include the work order numbers and serial numbers of the system components involved.

2200/ 2 - 24

COMPANY CONFIDENTIAL  
REPLACES: 02/01/84  
EFFECTIVE: 05/01/84

2200

UPGRADE JOB #	DESCRIPTION	PURCHASE PRICE
------------------	-------------	-------------------

The purchase charges listed include any applicable difference in prices. For purchase systems the incremental maintenance charge is also due.

FIXED DISKS (continued)

UPGRADES TO 16MB AND 32MB DISK OPTIONS REQUIRE THAT THE CPU BE EQUIPPED WITH A MVP/LVP C-OPTION.

UJ-5034	LVP-B to LVP-E (2MB to 16MB DR)	\$ 5,100
UJ-5035	LVP-B to LVP-F (2MB to 32MB DR)	7,300
UJ-5036	LVP-C to LVP-E (4MB to 16MB DR)	4,400
UJ-5037	LVP-C to LVP-F (4MB to 32MB DR)	6,600
UJ-5038	LVP-D to LVP-E (8MB to 16MB DR)	3,900
UJ-5039	LVP-D to LVP-F (8MB to 32MB DR)	6,100
UJ-5040	LVP-E to LVP-F (16MB to 32MB DR)	4,400

DISKS

UJ-930	2260B-1/4 to 2260B-1/2	\$ 1,100
UJ-931	2260B-1/4 to 2260B	1,650
UJ-932	2260B-1/2 to 2260B	550
UJ-933	2260C-1/4 to 2260C-1/2	1,100
UJ-934	2260C-1/4 to 2260C	1,650
UJ-935	2260C-1/4 to 2260C-2	11,200
UJ-936	2260C-1/2 to 2260C	550
UJ-937	2260C-1/2 to 2260C-2	10,100
UJ-938	2260C to 2260C-2	9,600
UJ-939	2260BC-1/4 to 2260BC-1/2	1,100
UJ-940	2260BC-1/4 to 2260BC	1,650
UJ-941	2260BC-1/4 to 2260BC-2	11,200

NOTE: All orders for add-ons and upgrade equipment MUST include the work order numbers and serial numbers of the system components involved.

UPGRADE  
JOB #

DESCRIPTION

PURCHASE  
PRICE

The purchase charges listed include any applicable difference in prices. For purchase systems the incremental maintenance charge is also due.

DISKS (continued)

UJ-942	2260BC-1/2 to 2260BC	\$ 550
UJ-943	2260BC-1/2 to 2260BC-2	10,100
UJ-944	2260BC to 2260BC-2	9,600
UJ-945	2260C to 2260BC	1,100
UJ-946	2270-1 to 2270-2	1,650
UJ-947	2270-1 to 2270-3	3,300
UJ-948	2270-2 to 2270-3	1,650
UJ-949	2270A-1 to 2270A-2	1,650
UJ-950	2270A-1 to 2270A-3	3,300
UJ-951	2270A-2 to 2270A-3	1,650
UJ-952	2270 to 2270A	440
UJ-953	2280-1 to 2280-2 2280N-1 to 2280N-2 (Field Upgradable)	1,100
UJ-954	2280-1 to 2280-3 2280N-1 to 2280N-3 (Field Upgradable)	2,200
UJ-955	2280-2 to 2280-3 2280N-2 to 2280N-3 (Field Upgradable)	1,100
UJ-5054	2275-10 to 2275-30	4,000
UJ-5055	2275-20 to 2275-60	5,500
<u>PRINTERS</u>		
UJ-980	2231W-1 to 2231W-2	\$ 330
UJ-1196	TSF & EF Upgrade for all DM-20	275
UJ-1226	Paper Tensioner for FT-1	125
UJ-990	2244A to 2244B	1,100

NOTE: All orders for add-ons and upgrade equipment MUST include the work order numbers and serial numbers of the system components involved.

UPGRADE JOB #	DESCRIPTION	PURCHASE PRICE
------------------	-------------	-------------------

The purchase charges listed include any applicable difference in prices. For purchase systems the incremental maintenance charge is also due.

MISCELLANEOUS

UJ-5025	2281W Envelope Feeder Electronics Only	\$ 275
UJ-5051	Expanded Control Memory Option	440

COMMUNICATIONS

UJ-5021	2228B to 2228C	\$ 440
UJ-5049	2228D-4E/4X to 2228D-8E/8X 0P28D-4E/4X to 0P28D-8E/8X (64K to 128K)	1,100

NOTE: All orders for add-ons and upgrade equipment MUST include the work order numbers and serial numbers of the system components involved.



2200VP

The 2200 system diagrams reflect configurations, and not system architecture. Your configuration should be based upon a combination of hardware/software that satisfies your particular applications. Included in each 2200 system diagram are the principle 2200 Central Processing Units, current device Controllers and the corresponding Peripherals. In addition, system maximums for the number of controllers and devices supported have been indicated for each CPU.

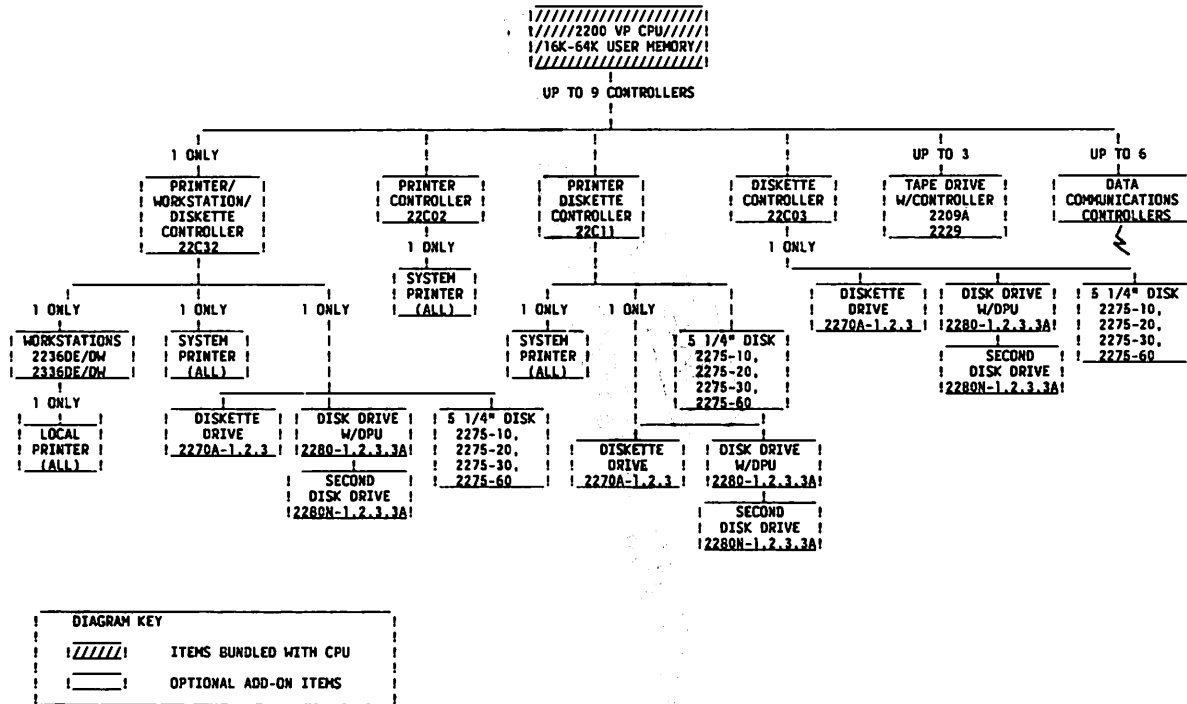

NOTE: All orders for add-ons and upgrade equipment MUST include the work order numbers and serial numbers of the system components involved.



## 2200SVP

The 2200 system diagrams reflect configurations, and not system architecture. Your configuration should be based upon a combination of hardware/software that satisfies your particular applications. Included in each 2200 system diagram are the principle 2200 Central Processing Units, current device Controllers and the corresponding Peripherals. In addition, system maximums for the number of controllers and devices supported have been indicated for each CPU.

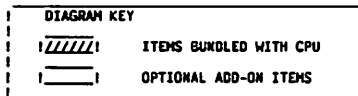
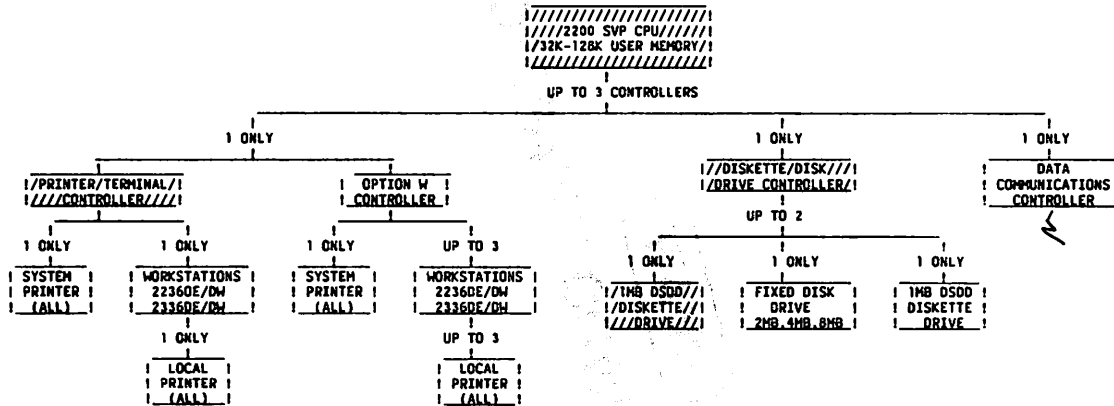

NOTE: All orders for add-ons and upgrade equipment MUST include the work order numbers and serial numbers of the system components involved.

2200LVP

The 2200 system diagrams reflect configurations, and not system architecture. Your configuration should be based upon a combination of hardware/software that satisfies your particular applications. Included in each 2200 system diagram are the principle 2200 Central Processing Units, current device Controllers and the corresponding Peripherals. In addition, system maximums for the number of controllers and devices supported have been indicated for each CPU.

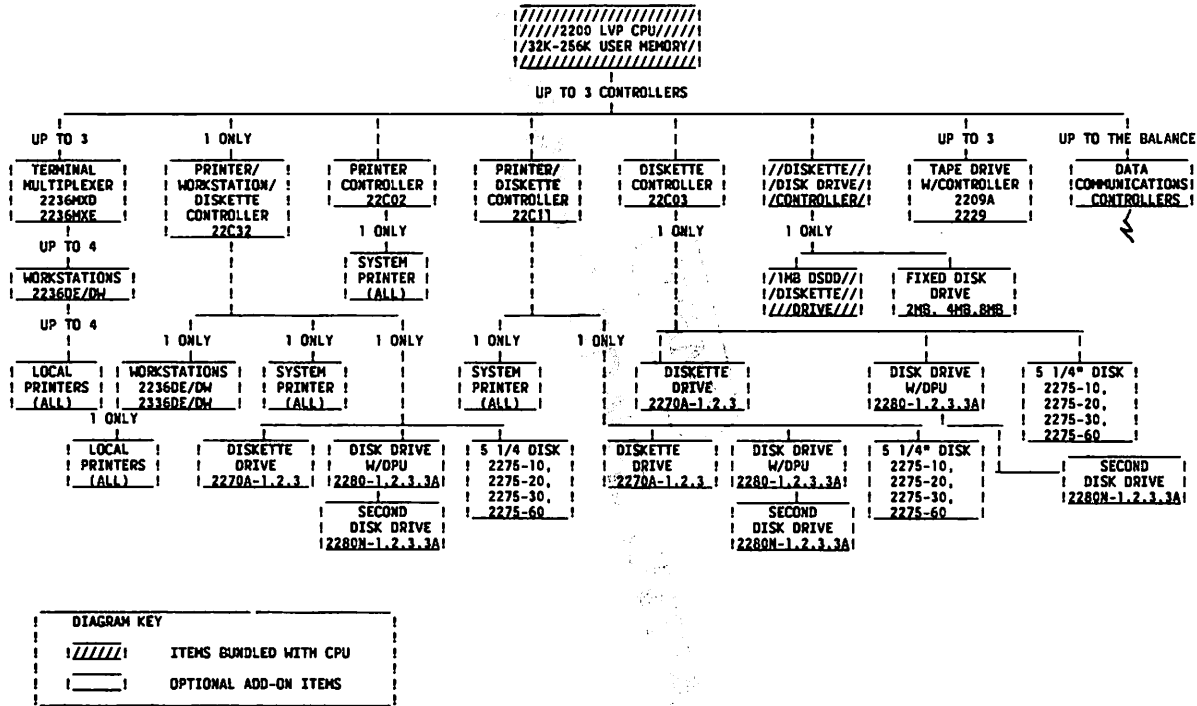

NOTE: All orders for add-ons and upgrade equipment MUST include the work order numbers and serial numbers of the system components involved.



## 2200MVP

The 2200 system diagrams reflect configurations, and not system architecture. Your configuration should be based upon a combination of hardware/software that satisfies your particular applications. Included in each 2200 system diagram are the principle 2200 Central Processing Units, current device Controllers and the corresponding Peripherals. In addition, system maximums for the number of controllers and devices supported have been indicated for each CPU.

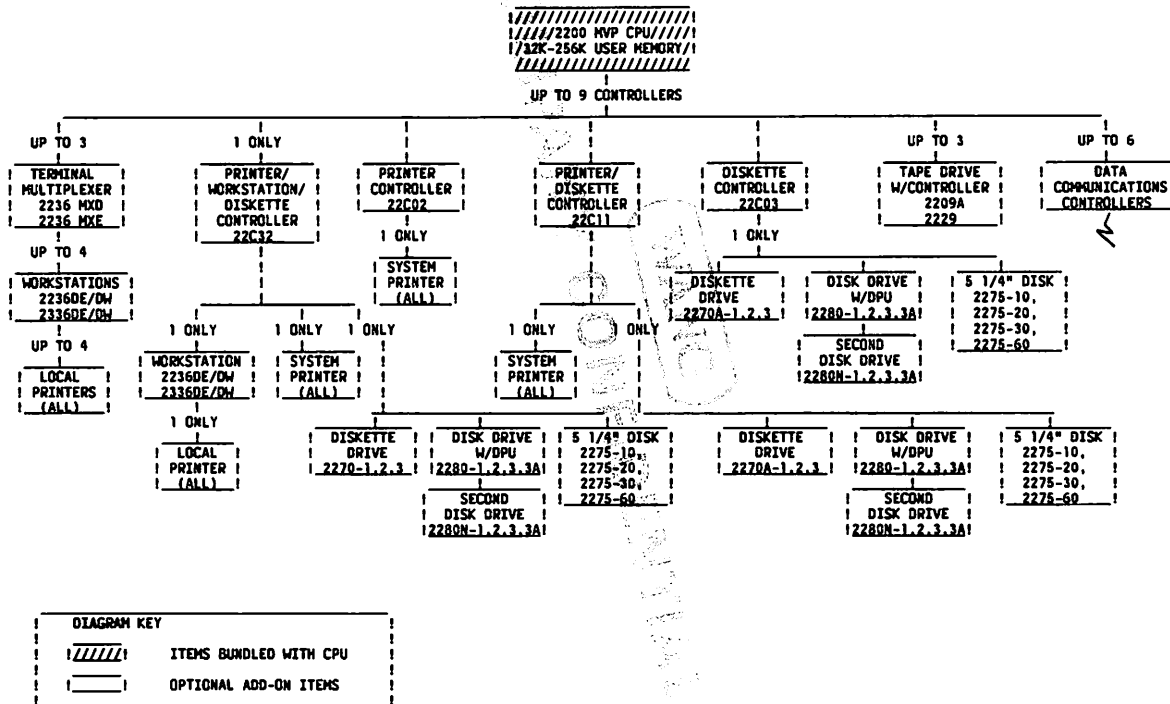

NOTE: All orders for add-ons and upgrade equipment MUST include the work order numbers and serial numbers of the system components involved.

2200 SYSTEMS  
ENTITLED SUPPORT SERVICES SUMMARY

<u>SUPPORT DESCRIPTION</u>	<u>Activity Codes</u>	<u>Support Hours Up to-</u>	<u>Site Loc. Wang/Cust</u>
<u>2200 Systems</u>			
<u>Pre-Installation</u>			
Pre-Installation Meeting	<u>EP01</u>	<u>4 hrs.</u>	<u>    </u> <u>X</u>
Shared Access System Time	<u>EP03</u>	<u>20 hrs.</u>	<u>X</u> <u>    </u>
<u>Post-Installation</u>			
Consultation	<u>EC01</u>	<u>4 hrs.</u>	<u>    </u> <u>X</u>

2200

ENTITLED SUPPORT SERVICES DOCUMENTATION: Wang will provide one complete set of user reference and/or training documentation per system.

The support service specified here is Entitled Support to be delivered within 90 days of installation in accordance with Wang Policy and is provided at no additional charge with the software procurement. If support services not specified here are requested, the service may be provided in accordance with Wang Policies and at Wang's per call rates and terms then in effect.

\* These hours are machine time hours on Wang equipment (not Support time for consultation). Shared access system time is to be used for developmental purposes only on an as available basis.

NOTE: All orders for add-ons and upgrade equipment MUST include the work order numbers and serial numbers of the system components involved.

SOFTWARE  
ENTITLED SUPPORT SERVICES SUMMARY

<u>SUPPORT DESCRIPTION</u>	<u>Activity Codes</u>	<u>Support Hours Up to</u>	<u>Site Loc. Wang/Cust</u>	<u>Class Training Up to</u>	<u># of Class Attendees at No Charge</u>
ATMS/MPS					
Pre-Installation Meeting	EP01	2 hrs.	X		
Technical Consultation	EC01	6 hrs.	X		
2200/MP					
Technical Consultation	EC01	4 hrs.	X		
VISUAL MEMORY					
Class Training	ET06		X	8 Hours	2 Operators
Technical Consultation	EC01	6 hrs.	X		
Pre-Installation Meeting	EP01	6 hrs.	X		
TIME MANAGEMENT					
Class Training	ET07		X	4 Hours	2 Operators
Technical Consultation	EC01	3 hrs.	X		
VOICE DOCUMENT					
Class Training	ET08		X	4 Hours	2 Operators
Technical Consultation	EC01	3 hrs.	X		
VS/MP					
Pre-Installation Meeting	EP01	2 hrs.	X		
Basic Word Processing Training	ET03		X	16 Hours	2 Operators*
Mathpak Training	ET05		X	4 Hours	1 Operator
Glossary Training	ET09		X	4 Hours	1 Operator
Technical Consultation	EC01	2 hrs.	X		

**ENTITLEMENT DOCUMENTATION:** For each of the above software products purchased by the customer, Wang will provide one complete set of user reference and/or training documentation per system.

The support service specified here is Entitled Support to be delivered within 90 days of installation in accordance with Wang Policy and is provided at no additional charge with the software procurement. If support services not specified here are requested, the service may be provided in accordance with Wang Policies and at Wang's per call rates and terms then in effect.

\* The customer is entitled to Basic Word Processing training for one operator for every ten workstations procured with the initial system order.

**NOTE:** All orders for add-ons and upgrade equipment MUST include the work order numbers and serial numbers of the system components involved.

2200

TELECOMMUNICATIONS PROTOCOLS  
ENTITLED SUPPORT SERVICES SUMMARY

<u>SUPPORT DESCRIPTION</u>	<u>Activity Codes</u>	<u>Support Hours Up to</u>	<u>Site Loc. Hang/Cust</u>
<u>Technical Consultation</u>			
--for Emulator Products	<u>EC01</u>	<u>4 hrs.</u>	<u>    X</u>
--for Networking Products	<u>EC01</u>	<u>6 hrs.</u>	<u>    X</u>

STANDARD NETWORKING PRODUCTS\*

ASYNCHRONOUS PROTOCOLS

Teletype Emulation (TTY/TTE)  
2741  
3741  
RCH (2200)  
BURROUGHS TC 500/700

BISYNCHRONOUS PROTOCOLS

2780/3780/WPS, VSCOPY  
HASP (IBM 360/20)  
U 100/200 (UNIVAC)  
UT 200 (CDC)  
2200-2200

STANDARD NETWORKING PRODUCTS\*

3270 Bisynch products  
3270 SNA/SDLC products  
3777 SNA/SDLC  
X.21 (Packet Switching)  
X.25 (Packet Switching)  
Teletex

\*Note: All telecommunications products, as they relate to the Professional Computer, are supported under the generic "Professional Computer Support Policy". No Entitled Support hours are provided.

ENTITLED SUPPORT SERVICES DOCUMENTATION: Wang will provide one complete set of user reference documentation for user reference for each product.

The support service specified here is Entitled Support to be delivered within 90 days of installation in accordance with Wang Policy and is provided at no additional charge with the equipment procurement. If support services not specified here are requested, the service may be provided in accordance with Wang Policies and at Wang's per call rates and terms then in effect.

NOTE: All orders for add-ons and upgrade equipment MUST include the work order numbers and serial numbers of the system components involved.

SECRET

CONFIDENTIAL





COMPANY CONFIDENTIAL

Effective Date: MAY 1, 1984

-Prices and equipment availability subject to change without notice-

VS PRODUCT LINE PRICE LIST

TABLE OF CONTENTS

<u>DESCRIPTION</u>	<u>PAGE</u>	<u>EFFECTIVE DATE</u>
<b>VS25/VS45 SYSTEMS</b>		
CENTRAL PROCESSING UNITS		
VS25	3	05/01/84
VS45	4	05/01/84
DEVICE CONTROLLERS		
Data Communication	5	05/01/84
Disk	6	05/01/84
UPGRADES		
CPU	6	05/01/84
Memory	6	05/01/84
Disk Device Controller	7	05/01/84
Disk	7	05/01/84
<b>VS80 SYSTEMS</b>		
CENTRAL PROCESSING UNITS		
VS80	8	05/01/84
IOP'S		
Serial Workstation, Printers,		
TCP'S	8	05/01/84
Data Communications	9	05/01/84
Tape Drives	9	05/01/84
Disk Drives	9	05/01/84
UPGRADES		
Disk Drive	10	05/01/84
Memory	10	05/01/84
<b>VS85/VS90/VS100 SYSTEMS</b>		
CENTRAL PROCESSING UNITS		
VS85	11	05/01/84
VS90	12	05/01/84
VS100	12	05/01/84
IOP'S		
Serial Workstation, Printers,		
TCP'S	13	05/01/84
Data Communications	13	05/01/84
Tape Drives	14	05/01/84
Disk Drives	14	05/01/84
UPGRADES		
Disk Drive	15	05/01/84
CPU	15	05/01/84
Memory	16	05/01/84
<b>VS100</b>		
CENTRAL PROCESSING UNITS		
VS100	19	05/01/84
IOP'S		
SERIAL WORKSTATIONS, PRINTERS	20	05/01/84
DATA COMMUNICATIONS	20	05/01/84
TAPE DRIVE	20	05/01/84
DISK DRIVE	20	05/01/84
UPGRADE		
DISK DRIVE	21	05/01/84
MEMORY	21	05/01/84

TABLE OF CONTENTS CONTINUED ON PAGE 2

**INSTALLATION CHARGES**

There is no installation charge for initial installation of system(s). For add-on equipment or upgrade that are not designated customer-installable there is an installation charge of 3% of the purchase price - minimum charge \$100 per order.

NOTE: All orders for add-ons and upgrade equipment MUST include the work order numbers and serial numbers of the system components involved.



WANG

COMPANY CONFIDENTIAL

VS PRODUCT LINE PRICE LIST

TABLE OF CONTENTS (continued)

<u>DESCRIPTION</u>	<u>PAGE</u>	<u>EFFECTIVE DATE</u>
WILST <sup>TM</sup> -WANG INTERACTIVE LEARNING SYSTEM	22	05/01/84
SOFTWARE	25	05/01/84
COMMUNICATIONS PROCESSORS AND OPTIONS	43	05/01/84
WORKSTATIONS	43	05/01/84
DISK SWITCHES	47	05/01/84
DISK DRIVES	47	05/01/84
MAGNETIC TAPE DRIVES WITHOUT IOP'S	48	05/01/84
6250 BPI MAGNETIC TAPE DRIVES WITHOUT IOP'S	49	05/01/84
PRINTERS	49	05/01/84
PRINTER OPTIONS	51	05/01/84
DISK CABLES	54	05/01/84
UPGRADES	58	05/01/84
TRADE-IN POLICY	63	05/01/84
GENERAL INFORMATION	64	05/01/84
CONFIGURATION GUIDES	65	05/01/84
ENTITLEMENT SUMMARY	77	05/01/84



CONFIDENTIAL

**INSTALLATION CHARGES**

There is no installation charge for initial installation of system(s). For add-on equipment or upgrade that are not designated customer-installable there is an installation charge of 3% of the purchase price - minimum charge \$100 per order.

**NOTE:** All orders for add-ons and upgrade equipment **MUST** include the work order numbers and serial numbers of the system components involved.

WANG

COMPANY CONFIDENTIAL

MODEL  
NUMBER

DESCRIPTION

PURCHASE  
PRICEMONTHLY  
MAINTENANCE-----M O N T H L Y R E N T A L P R I C E S-----  
1 YEAR 2 YEAR 3 YEAR 5 YEARVS25/VS45 SYSTEMSVS25 CENTRAL PROCESSING UNITS

Consists of Main Memory, 1.2MB DSDD Diskette Drive, 34MB, 68MB or 76MB Fixed Disk and Fixed Disk Device Controller, 16 Port Serial Device Controller and Wang supplied Modem for Remote Diagnostic purposes Only. Operating System and Assembler are standard. THE VS 25 SUPPORTS SERIAL DEVICES ONLY.

MODEL NUMBER	DESCRIPTION	PURCHASE PRICE	MONTHLY MAINTENANCE	1 YEAR	2 YEAR	3 YEAR	5 YEAR
VS25-8A	512KB Main Memory 34MB Fixed Disk	\$ 25,000	\$ 135	\$ 1,375	\$ 1,275	\$ 1,100	1,000
VS25-12A	768MB Main Memory 34MB Fixed Disk	27,000	150	1,485	1,377	1,188	1,080
VS25-16A	1024KB Main Memory 34MB Fixed Disk	29,000	165	1,595	1,479	1,276	1,160
VS25-8AN	512KB Main Memory 76MB Fixed Disk	31,500	157	1,733	1,607	1,386	1,260
VS25-12AN	768KB Main Memory 76MB Fixed Disk	33,500	172	1,843	1,709	1,474	1,340
VS25-16AN	1024KB Main Memory 76MB Fixed Disk	35,500	187	1,953	1,811	1,562	1,420
VS25-8C	512KB Main Memory (2) 34MB Fixed Disks	32,000	173	1,760	1,632	1,408	1,280
VS25-12C	768KB Main Memory (2) 34MB Fixed Disks	34,000	188	1,870	1,734	1,496	1,360
VS25-16C	1024KB Main Memory (2) 34MB Fixed Disks	36,000	203	1,980	1,836	1,584	1,440

PACKAGED SYSTEMS

NOTE: Compiler may be VS COBOL, FORTRAN, RPGII, BASIC or PL/1.

MODEL NUMBER	DESCRIPTION	PURCHASE PRICE	MONTHLY MAINTENANCE	1 YEAR	2 YEAR	3 YEAR	5 YEAR
VS25B	VS25-8A, 4205-VS Workstation, Compiler	\$ 25,000	\$ 135	\$ 1,275	\$ 1,150	\$ 1,100	1,000
VS25D	VS25-16A, 4205-VS Workstation, 1 Port Data Communications Controller, Tape Cartridge Drive, Compiler	34,000	232	1,734	1,564	1,496	1,360
VS25BN	VS25-8AN, 4205-VS Workstation, Compiler	31,500	157	1,733	1,607	1,386	1,260
VS25DN	VS25-16AN, 4205-VS Workstation, 2 Port Data Communications Controller, Tape Cartridge Drive, Compiler	40,500	260	2,228	2,066	1,782	1,620

NOTE: All orders for add-ons and upgrade equipment MUST include the work order numbers and serial numbers of the system components involved.



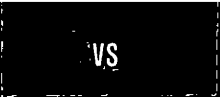

MODEL PURCHASE MONTHLY MONTHLY MONTHLY RENTAL PRICES-----  
 NUMBER PRICE MAINTENANCE 1 YEAR 2 YEAR 3 YEAR 5 YEAR

VS45 CENTRAL PROCESSING UNITS

Consists of Main Memory, 1.2MB OSDD Diskette Drive, 32 Port Serial Device Controller and Wang Supplied Modem for Remote Diagnostic purposes Only. Operating System and Assembler are standard. THE VS45 SUPPORTS SERIAL DEVICES ONLY.

"A", "C" or "AM" Models include 34MB, 68MB or 76MB Fixed Disk and Fixed Disk Device Controller. "X" Models DO NOT include Fixed Disk or Fixed Disk Device Controller. All Models support standard VS Disk Drives with the appropriate external Disk Device Controller (25V50-X). DISK CABLES MUST BE ORDERED FOR EACH EXTERNAL DISK.

MODEL NUMBER	DESCRIPTION	PURCHASE PRICE	MONTHLY MAINTENANCE	1 YEAR	2 YEAR	3 YEAR	5 YEAR
VS45-8X	512KB Main Memory	\$ 26,000	\$ 82	\$ 1,430	\$ 1,326	\$ 1,144	\$ 1,040
VS45-12X	768KB Main Memory	28,000	92	1,540	1,428	1,232	1,120
VS45-16X	1024KB Main Memory	30,000	102	1,650	1,530	1,320	1,200
VS45-8A	512KB Main Memory 34MB Fixed Disk	33,000	144	1,815	1,683	1,452	1,320
VS45-12A	768KB Main Memory 34MB Fixed Disk	35,000	159	1,925	1,785	1,540	1,400
VS45-16A	1024KB Main Memory 34MB Fixed Disk	37,000	174	2,035	1,887	1,628	1,480
VS45-8AN	512KB Main Memory 76MB Fixed Disk	39,500	166	2,173	2,015	1,738	1,580
VS45-12AN	768KB Main Memory 76MB Fixed Disk	41,500	181	2,283	2,117	1,826	1,660
VS45-16AN	1024KB Main Memory 76MB Fixed Disk	43,500	196	2,393	2,219	1,914	1,740
VS45-8C	512KB Main Memory (2) 34MB Fixed Disks	40,000	182	2,200	2,040	1,760	1,600
VS45-12C	768KB Main Memory (2) 34MB Fixed Disks	42,000	197	2,310	2,142	1,848	1,680
VS45-16C	1024KB Main Memory (2) 34MB Fixed Disks	44,000	212	2,420	2,244	1,936	1,760

PACKAGED SYSTEMS

NOTE: Compiler may be VS COBOL, FORTRAN, RPGII, BASIC or PL/1.

VS45E	VS45-16X, 90MB Fixed/Removable Disk, 2 Port Disk Device Controller, 1 Port Data Communications Controller, 4205-VS Workstation, Disk Cables, Compiler	\$ 48,000	\$ 364	\$ 2,448	\$ 2,208	\$ 2,112	\$ 1,920
-------	---	-----------	--------	----------	----------	----------	----------

NOTE: All orders for add-ons and upgrade equipment MUST include the work order numbers and serial numbers of the system components involved.

MODEL  
NUMBER

DESCRIPTION

PURCHASE  
PRICEMONTHLY  
MAINTENANCE-----MONTHLY RENTAL PRICES-----  
1 YEAR 2 YEAR 3 YEAR 5 YEARPACKAGED SYSTEMS (continued)

NOTE: Compiler may be VS COBOL, FORTRAN, RPGII, BASIC or PL/I.

VS45F	VS45-16X, 288MB Removable Disk, 2 Port Disk Device Controller, 1 Port Data Communications Controller, 4205-VS Workstation, Disk Cables, Compiler	\$ 63,000	\$ 433	\$ 2,703	\$ 2,438	\$ 2,332	2,120
VS45G	VS45-16X, (2) 75MB Removable Disk, 2 Port Disk Device Controller, 1 Port Data Communications Controller, 4205-VS Workstation, Disk Cables, Compiler	63,000	498	3,213	2,898	2,772	2,520
VS45GN	VS45-16AM, 4205-VS Workstation, 2 Port Data Communications Controller, (1) 75MB Removable Disk, 2 Port Disk Device Controller, Cables, Compiler	61,000	438	3,355	3,111	2,684	2,440

VS25/VS45 WORD PROCESSING OPTION

VS25/45-WP	Word Processing Option including: 2276C-3 64K VS Archiving Workstation with Combined Keyboard, HS & SS Controller, and or Word Processing Software. FOR VS25 AND VS45 ONLY.	\$ 10,000	\$ 108	\$ 560	\$ 510	\$ 440	400
VS25/45-MPI	Word Processing Option including: 2850-7 64K Ergonomic VS Archiving Workstation with Combined Keyboard, HS & SS Controller, and Word Processing Software. FOR VS25 AND VS45 ONLY.	10,300	108	567	526	485	443

VS25/VS45 DEVICE CONTROLLERS  
DATA COMMUNICATIONS DEVICE CONTROLLER

Maximum distance of a communications line from the CPU (IOP) is 50 feet/15.2 meters. A 25 foot/7.6 meter cable with a RS-232 interface is provided at no charge, for each port available on a 22V06, 22V26 IOP or 25V76. The maximum length is 50 foot/15.3 meter available as a substitute for the standard 25 foot/7.6 meter cable. Cable lengths must be submitted with the system/peripheral order.

25V76-1	VS25/45 Single Port Data Communications Device Controller. Provides one Data Link Processor.	\$ 1,660	\$ 14	\$ 91	\$ 85	\$ 73	66
---------	--	----------	-------	-------	-------	-------	----

NOTE: All orders for add-ons and upgrade equipment MUST include the work order numbers and serial numbers of the system components involved.





MODEL NUMBER	DESCRIPTION	PURCHASE PRICE	MONTHLY MAINTENANCE	-----MONTHLY RENTAL PRICES-----			
				1 YEAR	2 YEAR	3 YEAR	5 YEAR

DATA COMMUNICATIONS DEVICE CONTROLLER (continued)

Maximum distance of a communications line from the CPU (IOP) is 50 feet/15.2 meters. A 25 foot/7.6 meter cable with a RS-232 interface is provided at no charge, for each port available on a 22V06, 22V26 IOP or 25V76. The maximum length is 50 foot/15.3 meter available as a substitute for the standard 25 foot/7.6 meter cable. Cable lengths MUST be submitted with the system/peripheral order.

25V76-2	VS25/45 Dual Port Data Communications Device Controller. Provides two Data Link Processors	\$ 2,400	\$ 20	\$ 132	\$ 123	\$ 106	\$ 96
---------	--	----------	-------	--------	--------	--------	-------

VS45 DISK DEVICE CONTROLLERS

Controls up to four models of any supported disk drives in any combination. Supports 2265V-1,-2,-3; 2280V-1,-2,-3. Limit of one disk device controller on VS45. Disk cables must be ordered for each external disk.

25V50-1	1 Port Disk Device Controller (VS45 ONLY)	\$ 6,500	\$ 47	\$ 358	\$ 332	\$ 286	\$ 260
25V50-2	2 Port Disk Device Controller (VS45 ONLY)	7,500	62	413	383	330	300
25V50-3	3 Port Disk Device Controller (VS45 ONLY)	8,500	77	468	434	374	340
25V50-4	4 Port Disk Device Controller (VS45 ONLY)	9,500	92	523	485	418	380

VS25/VS45 TAPE DRIVE

2509V	9-Track, 1600-BPI Tape Drive and Controller	\$ 17,500	\$ 137	\$ 963	\$ 893	\$ 770	\$ 700
-------	---	-----------	--------	--------	--------	--------	--------

UPGRADE JOB #	DESCRIPTION	PURCHASE PRICE	-----R E N T A L-----			
			SINGLE CHARGE	OR	MONTHLY 1 YEAR	

The purchase/rental charges listed include any applicable difference in prices. For purchase systems the incremental maintenance charge is also due.

VS25/VS45 UPGRADES

VS25/VS45 CPU UPGRADE

UJ-3139	VS25 to VS45	\$ 8,800	\$ 3,000	\$ 300			
---------	--------------	----------	----------	--------	--	--	--

VS25/VS45 MEMORY UPGRADES

UJ-3150	VS25/VS45 (512K to 768K)	\$ 3,000	\$ 1,000	\$ 100			
UJ-3151	VS25/VS45 (512K to 1024K)	5,000	1,000	100			

NOTE: All orders for add-ons and upgrade equipment MUST include the work order numbers and serial numbers of the system components involved.



UPGRADE JOB #	DESCRIPTION	PURCHASE PRICE	-----R E N T A L-----		
			SINGLE CHARGE	OR	MONTHLY 1 YEAR
The purchase/rental charges listed include any applicable difference in prices. For purchase systems the incremental maintenance charge is also due.					
<u>VS25/VS45 MEMORY UPGRADES (continued)</u>					
UJ-3152	VS25/VS45 (768K to 1024K)	\$ 3,000	\$ 1,000		\$ 100
<u>VS25/VS45 DATA COMMUNICATIONS DEVICE CONTROLLER UPGRADE</u>					
UJ-3182	25V76-1 to 25V76-2	\$ 1,000	\$ 1,000		\$ 100
<u>VS45 DISK DEVICE CONTROLLER UPGRADES</u>					
UJ-3164	25V50-1 to 25V50-2	\$ 1,650	\$ 500		\$ 50
UJ-3165	25V50-1 to 25V50-3	2,500	500		50
UJ-3166	25V50-1 to 25V50-4	3,500	500		50
UJ-3167	25V50-2 to 25V50-3	1,650	500		50
UJ-3168	25V50-2 to 25V50-4	2,750	500		50
UJ-3169	25V50-3 to 25V50-4	1,500	500		50
<u>VS25/VS45 DISK UPGRADES</u>					
UJ-3140	VS25/45-A to VS25/45-C (34MB Fixed Disk to 68MB Fixed Disk)	\$ 8,500	\$ 1,500		\$ 150
UJ-3141	VS45-X to VS45-A (No Fixed Disk to 34MB Fixed Disk. In- cludes Fixed Disk Controller)	8,250	2,000		200
UJ-3142	VS45-X to VS45-C (No Fixed Disk to 68MB Fixed Disk. In- cludes Fixed Disk Controller)	15,500	3,000		300
UJ-3246	VS45-X to VS45-N (No Fixed Disk to 76MB Fixed Disk. In- cludes Fixed Disk Controller)	15,500	1,000		100
UJ-3247	VS25/45-A to VS25/45-N (34MB Fixed Disk to 76MB Fixed Disk. Includes Fixed Disk Control- ler)	13,000	5,500		550
UJ-3248	VS25/45-C to VS25/45-N (68MB Fixed Disk to 76MB Fixed Disk. Includes Fixed Disk Control- ler)	11,000	10,000		1,000

NOTE: All orders for add-ons and upgrade equipment MUST include the work order numbers and serial numbers of the system components involved.



MODEL NUMBER	DESCRIPTION	PURCHASE PRICE	MONTHLY MAINTENANCE	MONTHLY RENTAL PRICES			
				1 YEAR	2 YEAR	3 YEAR	5 YEAR

VS80 SYSTEMSVS80 CENTRAL PROCESSING UNITS

Consists of main memory, one 300 KB diskette drive and its input/output processor (IOP), and a chassis capable of accommodating a total of eight (8) IOPs. Operating System and assembler are standard.

VS-8C	256KB Main Memory	\$ 20,000	\$ 330	\$ 969	\$ 874	\$ 760	722
VS-12C	384KB Main Memory	26,000	380	1,275	1,150	1,000	950
VS-16C	512KB Main Memory	30,000	430	1,479	1,334	1,160	1,102

VS80 IOP'SSERIAL WORKSTATION, PRINTERS AND TCP'S

When a VS-80 is traded in for a VS-85/90/100 the IOP's for the VS-85/90/100 must be ordered with the CPU. When an IOP is being returned with the VS-80 there will be no charge for the same IOP on the VS-85/90/100. Reference must be made to the work order(s) on which the original IOP's were ordered.

The maximum distance for serial device from the CPU (IOP) is 2000 feet/609 meters. A 25 foot/7.6 meter cable is shipped with each serial peripheral device. Cable lengths must be submitted with the system/peripheral order.

22V17-1	VS-80 IOP for serial devices. Provides up to eight (8) serial ports.	\$ 2,500	\$ 18	\$ 138	\$ 128	\$ 110	100
22V17-2	VS-80 IOP for serial devices. Provides up to sixteen (16) serial ports.	3,000	30	165	153	132	120
22V57W	VS-80 IOP for WangNet attachment to drive up to 32 terminals	4,100	50	193	189	181	164

NOTE: All orders for add-ons and upgrade equipment MUST include the work order numbers and serial numbers of the system components involved.

MODEL  
NUMBER

DESCRIPTION

PURCHASE  
PRICEMONTHLY  
MAINTENANCE

-----M O N T H L Y R E N T A L P R I C E S-----

1 YEAR      2 YEAR      3 YEAR      5 YEAR

DATA COMMUNICATIONS

When a VS-80 is traded in for to a VS-85/90/100 the IOP's for the VS-85/90/100 must be ordered with the CPU. When an IOP is being returned with the VS-80 there will be no charge for the same IOP on the VS-85/90/100. Reference must be made to the work order(s) on which the original IOP's were ordered.

Maximum distance of a communications line from the CPU (IOP) is 50 feet/15.2 meters. A 25 foot/7.6 meter cable with a RS-232 interface is provided at no charge, for each port available on a 22V06, 22V26 IOP or 25V76. The maximum length is 50 foot/15.3 meter available as a substitute for the standard 25 foot/7.6 meter cable. Cable lengths must be submitted with the system/peripheral order.

MODEL NUMBER	DESCRIPTION	PURCHASE PRICE	MONTHLY MAINTENANCE	1 YEAR	2 YEAR	3 YEAR	5 YEAR
22V06-1	VS-80 Data Communications IOP. Provides one Data Link Processor.	\$ 3,000	\$ 44	\$ 165	\$ 153	\$ 132	120
22V06-2	VS-80 Data Communications IOP. Provides two Data Link Processors.	3,800	55	209	194	168	152
22V06-3	VS-80 Data Communications IOP. Provides three Data Link Processors.	4,600	66	253	235	203	184

TAPE DRIVE

When a VS-80 is traded in for a VS-85/90/100 the IOP's for the VS-85/90/100 must be ordered with the CPU. When an IOP is being returned with the VS-80 there will be no charge for the same IOP on the VS-85/90/100. Reference must be made to the work order(s) on which the original IOP's were ordered.

MODEL NUMBER	DESCRIPTION	PURCHASE PRICE	MONTHLY MAINTENANCE	1 YEAR	2 YEAR	3 YEAR	5 YEAR
22V05-2	VS-80 IOP for Magnetic Tape Drive: controls up to four 2209V, 2209V-2 or 2209V-3 Tape Drives.	\$ 3,500	\$ 17	\$ 193	\$ 179	\$ 154	140
22V15-1	VS-80 IOP for 2219V series Tape Drives	4,500	27	248	230	198	180

DISK DRIVE

When a VS-80 is traded in for a VS-85/90/100 the IOP's for the VS-85/90/100 must be ordered with the CPU. When an IOP is being returned with the VS-80 there will be no charge for the same IOP on the VS-85/90/100. Reference must be made to the work order(s) on which the original IOP's were ordered.

MODEL NUMBER	DESCRIPTION	PURCHASE PRICE	MONTHLY MAINTENANCE	1 YEAR	2 YEAR	3 YEAR	5 YEAR
22V78-1	1 Port Disk IOP for 90/75/288/640MB Disks. For VS80. Limit of two IOPs on VS80.	\$ 6,500	\$ 47	\$ 358	\$ 332	\$ 286	260
22V78-2	2 Port Disk IOP for 90/75/288/640MB Disks. For VS80. Limit of two IOPs on VS80.	7,500	62	413	383	330	300
22V78-3	3 Port Disk IOP for 90/75/288/640MB Disks. For VS80. Limit of two IOPs on VS80.	8,500	77	468	434	374	340

NOTE: All orders for add-ons and upgrade equipment MUST include the work order numbers and serial numbers of the system components involved.

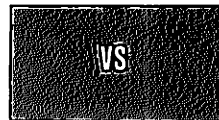

MODEL NUMBER	DESCRIPTION	PURCHASE PRICE	MONTHLY MAINTENANCE	----- MONTHLY RENTAL PRICES -----			
				1 YEAR	2 YEAR	3 YEAR	5 YEAR
<u>DISK DRIVE (continued)</u>							
22V78-4	4 Port Disk IOP for 90/75/288/640MB Disks. For VS80. Limit of two IOPs on VS80.	\$ 9,500	\$ 92	\$ 523	\$ 485	\$ 418	380
22V08	VS-80 IOP for 90/75/288MB Disk: Controls up to four models of any supported Disk Drive in any combination. Supports 2265V-1, 2 and 2280V-3. Limit of two IOPs on VS-80.	7,500	50	413	383	330	300
22V38	VS-80 IOP for SM04 and SM04-1 Switches. Controls up to four disks. Supports 90, 75, 288MB Disk Drives in any combination. Limit of two IOPs on VS-80.	7,500	50	413	383	330	300
UPGRADE JOB #	DESCRIPTION	PURCHASE PRICE		----- R E N T A L -----			
				SINGLE CHARGE	OR	MONTHLY	1 YEAR

The purchase/rental charges listed include any applicable difference in prices. For purchase systems the incremental maintenance charge is also due.

DISK DRIVE UPGRADES

UJ-3256	22V78-1 to 22V78-2	\$ 1,500		\$ 500	\$ 50
UJ-3257	22V78-1 to 22V78-3	3,000		1,000	100
UJ-3258	22V78-1 to 22V78-4	4,500		1,500	150
UJ-3259	22V78-2 to 22V78-3	1,500		500	50
UJ-3260	22V78-2 to 22V78-4	3,000		1,000	100
UJ-3261	22V78-3 to 22V78-4	1,500		500	50

VS80 UPGRADES

VS-80 MEMORY UPGRADES

UJ-542	VS-4B to VS-8B	\$ 6,500		\$ 1,000	\$ 100
UJ-543	VS-4C to VS-8C				
UJ-543	VS-4B to VS-12B	10,500		1,000	100
UJ-544	VS-4C to VS-12C				
UJ-544	VS-4B to VS-16B	14,500		1,000	100
UJ-545	VS-4C to VS-16C				
UJ-545	VS-8B to VS-12B	6,500		1,000	100
UJ-546	VS-8C to VS-12C				
UJ-546	VS-8B to VS-16B	10,500		1,000	100
UJ-547	VS-8C to VS-16C				
UJ-547	VS-12B to VS-16B				
UJ-547	VS-12C to VS-16C	6,500		1,000	100

NOTE: All orders for add-ons and upgrade equipment MUST include the work order numbers and serial numbers of the system components involved.

MODEL NUMBER	DESCRIPTION	PURCHASE PRICE	MONTHLY MAINTENANCE	-----MONTHLY RENTAL PRICES-----			
				1 YEAR	2 YEAR	3 YEAR	5 YEAR

VS85/VS90/VS100 SYSTEMS

VS85 CENTRAL PROCESSING UNITS

Consists of main memory, a 16 port serial IOP, one combined archiving workstation with hard sector/soft sector controller, and one bus adapter. Operating system and Assembler are standard. Only serial devices may be attached to the system through an appropriate IOP.

VS85-1	1024KB Main Memory	\$ 64,000	\$ 294	\$ 3,520	\$ 3,264	\$ 2,816	\$ 2,560
VS85-2	2048KB Main Memory	74,000	344	4,070	3,774	3,256	2,960
VS85-4	4096KB Main Memory	92,000	444	5,060	4,692	4,048	3,680

PACKAGED SYSTEMS

NOTE: Compiler may be VS COBOL, FORTRAN, RPGII, BASIC or PL/I.

VS85E	VS85-1, 90MB Fixed/Removable Disk, 2 Port Disk IOP, 3 Port Data Communications IOP, Disk Cables, Compiler	\$ 79,000	\$ 572	\$ 4,029	\$ 3,634	\$ 3,476	\$ 3,160
VS85F	VS85-1, 288MB Removable Disk, 2 Port Disk IOP, 3 Port Data Communications IOP, Disk Cables, Compiler	84,000	641	4,284	3,864	3,696	3,360
VS85G	VS85-1, (2) 75MB Removable Disks, 2 Port Disk IOP, 3 Port Data Communications IOP, Disk Cables, Compiler	94,000	706	4,794	4,324	4,136	3,760
VS85-76F	VS85-1, 2 Port Disk IOP, 3 Port Data Communications IOP, 76MB Fixed Disk, Compiler	70,000	482	3,570	3,220	3,080	2,800
VS85-147F	VS85-1, 2 Port Disk IOP, 3 Port Data Communications IOP, 147MB Fixed Disk, Compiler	77,000	508	3,927	3,542	3,388	3,080

SYSTEM EXPANSION (VS85-2 and VS85-4 MODELS ONLY)

NOTE: VS85-1 CPUS AND VS85 PACKAGE SYSTEMS (1MB MAIN MEMORY) REQUIRE MEMORY UPGRADE TO SUPPORT CACHE.

85-CACHE	32KB Cache Memory	\$ 7,500	\$ 60	\$ 413	\$ 383	\$ 330	\$ 300
----------	-------------------	----------	-------	--------	--------	--------	--------

NOTE: All orders for add-ons and upgrade equipment MUST include the work order numbers and serial numbers of the system components involved.



MODEL NUMBER	DESCRIPTION	PURCHASE PRICE	MONTHLY MAINTENANCE	-----MONTHLY RENTAL PRICES-----			
				1 YEAR	2 YEAR	3 YEAR	5 YEAR

VS90 CENTRAL PROCESSING UNITS

Consists of main memory, a 16 port serial IOP, one combined archiving workstation with hard sector/soft sector controller, and one bus adapter. Operating system and assembler are standard. ONLY SERIAL DEVICES may be attached to the system through an appropriate IOP.

VS90-1A	1024KB Main Memory	\$ 76,000	\$ 338	\$ 4,180	\$ 3,876	\$ 3,344	\$ 3,040
VS90-2A	2048KB Main Memory	86,000	388	4,730	4,386	3,784	3,440
VS90-3A	3072KB Main Memory	95,000	438	5,226	4,845	4,180	3,800
VS90-4A	4096KB Main Memory	104,000	488	5,720	5,304	4,576	4,160

VS100 CENTRAL PROCESSING UNITS

Consists of main memory, cache memory, and a chassis capable of accommodating Sixteen (16) IOPs. One Bus Adapter which provides an interface for eight (8) IOPs is standard. One additional Bus Adapter is optional at extra cost. Operating system and assembler are standard. ALL systems include a 16 port serial IOP and one combined archiving workstation with hard sector/soft sector controller. Only serial devices may be attached to the system through an appropriate IOP.

VS-32G	1024KB Main Memory	\$ 85,000	\$ 776	\$ 4,675	\$ 4,335	\$ 3,740	\$ 3,400
VS-64G	2048KB Main Memory	95,000	826	5,225	4,845	4,180	3,800
VS-96G	3072KB Main Memory	104,000	876	5,720	5,304	4,576	4,160
VS-128G	4096KB Main Memory	113,000	926	6,215	5,763	4,972	4,520
VS-160G	5120KB Main Memory	121,000	976	6,655	6,171	5,324	4,840
VS-192G	6144KB Main Memory	129,000	1,026	7,095	6,579	5,676	5,160
VS-224G	7168KB Main Memory	137,000	1,076	7,535	6,987	6,028	5,480
VS-256G	8192KB Main Memory	145,000	1,126	7,975	7,395	6,380	5,800

SYSTEM EXPANSION (VS-100 MODELS ONLY)

Have CE field inspect to determine Bus Adapter type.

-----  
If Bus Adapter PCA type is 210-7911:

CD-1001	Additional Bus Adapter to support up to 8 more IOPs on the VS-100 only.	\$ 9,000	\$ 50	\$ 495	\$ 459	\$ 396	\$ 360
---------	---	----------	-------	--------	--------	--------	--------

If Bus Adapter PCA type is 210-7611:

CD-1002	Additional Bus Adapter to support up to 8 more IOPs on the VS-100 only.	9,000	50	495	459	396	360
---------	---	-------	----	-----	-----	-----	-----

NOTE: All orders for add-ons and upgrade equipment MUST include the work order numbers and serial numbers of the system components involved.

MODEL NUMBER	DESCRIPTION	PURCHASE PRICE	MONTHLY MAINTENANCE	-----MONTHLY RENTAL PRICES-----			
				1 YEAR	2 YEAR	3 YEAR	5 YEAR

VS85/VS90/VS100 IOP'S

SERIAL WORKSTATIONS, PRINTERS AND TCP'S

When a VS-80 is traded in for a VS-85/90/100 the IOP's for the VS-85/90/100 must be ordered with the CPU. When an IOP is being returned with the VS-80 there will be no charge for the same IOP on the VS-VS/90/100. Reference must be made to the work order(s) on which the original IOP's were ordered.

The maximum distance for serial device from the CPU (IOP) is 2000 feet/609 meters. A 25 foot/7.6 meter cable is shipped with each serial peripheral device. Cable lengths must be submitted with the system/peripheral order.

22V27-1	VS-85/90/100 IOP for serial devices. Provides up to eight (8) serial ports	\$ 3,000	\$ 18	\$ 165	\$ 153	\$ 132	120
22V27-2	VS-85/90/100 IOP for serial devices. Provides up to sixteen (16) serial ports	3,500	30	193	179	154	140
22V67W	VS-85/90/100 IOP for WangNet attachment to drive up to 32 terminals	4,100	50	193	189	181	164
22V67W-A	Additional IOP for WanNet attachment on a VS85/90/100 which already has one 22V67W	4,075	50	208	188	180	163

DATA COMMUNICATIONS

When a VS-80 is traded in for to a VS-85/90/100 the IOP's for the VS-85/90/100 must be ordered with the CPU. When an IOP is being returned with the VS-80 there will be no charge for the same IOP on the VS-85/90/100. Reference must be made to the work order(s) on which the original IOP's were ordered.

Maximum distance of a communications line from the CPU (IOP) is 50 feet/15.2 meters. A 25 foot/7.6 meter cable with a RS-232 interface is provided at no charge, for each port available on a 22V06, 22V26 IOP or 25V76. The maximum length is 50 foot/15.3 meter available as a substitute for the standard 25 foot/7.6 meter cable. Cable lengths must be submitted with the system/peripheral order.

22V26-1	VS-85/90/100 Data Communications IOP. Provides one Data Link Processor.	\$ 3,000	\$ 44	\$ 165	\$ 153	\$ 132	120
22V26-2	VS-85/90/100 Data Communications IOP. Provides two Data Link Processors.	3,800	55	209	194	168	152
22V26-3	VS-85/90/100 Data Communications IOP. Provides three Data Link Processors.	4,600	66	253	235	203	184

NOTE: All orders for add-ons and upgrade equipment MUST include the work order numbers and serial numbers of the system components involved.



VS

MODEL NUMBER	DESCRIPTION	PURCHASE PRICE	MONTHLY MAINTENANCE	MONTHLY RENTAL PRICES			
				1 YEAR	2 YEAR	3 YEAR	5 YEAR

TAPE DRIVE

When a VS-80 is traded in for a VS-85/90/100 the IOP's for the VS-85/90/100 must be ordered with the CPU. When an IOP is being returned with the VS-80 there will be no charge for the same IOP on the VS-85/90/100. Reference must be made to the work order(s) on which the original IOP's were ordered.

22V25-2	VS-85/90/100 IOP for Magnetic Tape Drive: controls up to four 2209V, 2209V-2 or 2209V-3 Tape Drives.	\$ 3,500	\$ 17	\$ 193	\$ 179	\$ 154	140
22V15-2	VS-85/90/100 IOP for 2219V series Tape Drives. (Requires cache option when installed on a VS85)	4,500	27	248	230	198	180

DISK DRIVE

When a VS-80 is traded in for a VS-85/90/100 the IOP's for the VS-85/90/100 must be ordered with the CPU. When an IOP is being returned with the VS-80 there will be no charge for the same IOP on the VS-85/90/100. Reference must be made to the work order(s) on which the original IOP's were ordered.

22V88-1	1 Port Disk IOP for 90/75/288/640MB Disks. For VS85/90/100. Limit of four IOPs on VS100, two IOPs on VS90 or VS85 with Cache, one IOP on VS85 without Cache.	\$ 6,500	\$ 47	\$ 358	\$ 332	\$ 286	260
22V88-2	2 Port Disk IOP for 90/75/288/640MB Disks. For VS85/90/100. Limit of four IOPs on VS100, two IOPs on VS90 or VS85 with Cache, one IOP on VS85 without Cache.	7,500	62	413	383	330	300
22V88-3	3 Port Disk IOP for 90/75/288/640MB Disks. For VS85/90/100. Limit of four IOPs on VS100, two IOPs on VS90 or VS85 with Cache, one IOP on VS85 without Cache.	8,500	77	468	434	374	340
22V88-4	4 Port Disk IOP for 90/75/288/640MB Disks. For VS85/90/100. Limit of two IOPs on VS100, two IOPs on VS90 or VS85 with Cache, one IOP on VS85 without Cache.	9,500	92	523	485	418	380

NOTE: All orders for add-ons and upgrade equipment MUST include the work order numbers and serial numbers of the system components involved.



MODEL NUMBER	DESCRIPTION	PURCHASE PRICE	MONTHLY MAINTENANCE	-----MONTHLY RENTAL PRICES-----			
				1 YEAR	2 YEAR	3 YEAR	5 YEAR

DISK DRIVE (continued)

22V28	VS-85/90/100 IOP for 90/75/288MB Disk: Controls up to four models of any supported Disk Drive in any combination. Supports the 2280V-3 and 2265V-1,-2. Limit of four disk IOP's on VS100, two disk IOP's on VS90 or VS85 with cache, one disk IOP on VS85 without cache.	\$ 7,500	\$ 50	\$ 413	\$ 383	\$ 330	300
22V48	VS-85/90/100 IOP for SW04 and SW04-1 Switchs. Controls up to four disks. Supports 90/75/288MB Disk Drives in any combination. Limit of four disk IOPs on VS100, two on VS90 or VS85 with cache, one disk IOP on VS85 without cache	7,500	50	413	383	330	300

UPGRADE JOB #	DESCRIPTION	PURCHASE PRICE	-----R E N T A L-----	
			SINGLE CHARGE	OR MONTHLY 1 YEAR

The purchase/rental charges listed include any applicable difference in prices. For purchase systems the incremental maintenance charge is also due.

DISK DRIVE UPGRADES

UJ-3262	22V88-1 to 22V88-2	\$ 1,500	\$ 500	\$ 50
UJ-3263	22V88-1 to 22V88-3	3,000	1,000	100
UJ-3264	22V88-1 to 22V88-4	4,500	1,500	150
UJ-3265	22V88-2 to 22V88-3	1,500	500	50
UJ-3266	22V88-2 to 22V88-4	3,000	1,000	100
UJ-3267	22V88-3 to 22V88-4	1,500	500	50

VS85/90/100 UPGRADES

VS85/VS90/100 CPU UPGRADE

NOTE: VS85 is not upgradable to VS90

UJ-3130	VS-90 to VS-100	\$ 10,000	\$ 4,000	\$ 400
UJ-4001	VS85-2 to VS-64G	20,000	4,000	400
UJ-4002	VS85-4 to VS-128G	20,000	4,000	400

NOTE: All orders for add-ons and upgrade equipment MUST include the work order numbers and serial numbers of the system components involved.

COMPANY CONFIDENTIAL  
 REPLACES: 02/01/84  
 EFFECTIVE: 05/01/84





UPGRADE JOB #	DESCRIPTION	PURCHASE PRICE	R E N T A L	
			SINGLE CHARGE	OR MONTHLY 1 YEAR

The purchase/rental charges listed include any applicable difference in prices. For purchase systems the incremental maintenance charge is also due.

VS85 MEMORY UPGRADES

UJ-3188	Memory Upgrade 1MB to 2MB (Will receive (2) 210-7803-2A) (Must Return (2) 210-7803-1A US ONLY)	\$ 12,000	\$ 2,000	\$ 200
UJ-3192	Memory Upgrade 2MB to 4MB (Will receive (2) 210-8203) (Must return (2) 210-7803-4A US ONLY)	24,000	6,000	600

VS90 MEMORY UPGRADES

UJ-3176	Memory Upgrade 1MB to 2MB Memory Upgrade 3MB to 4MB (Will receive (2) 210-7803-4A) (Must return (2) 210-7803-2A US ONLY)	\$ 12,000	\$ 1,000	\$ 100
UJ-3177	Memory Upgrade 1MB to 3MB Memory Upgrade 2MB to 4MB (Will receive (2) 210-7803-4A) (Place 210-7803-2A in last)	24,000	1,000	100
UJ-3132	Memory Upgrade 2MB to 3MB (Will receive (2) 210-7803-2A)	12,000	1,000	100

VS100 MEMORY UPGRADES

If the installation already has a VS-16F to VS-64F, have CE field inspect to determine Memory board type. PCA 210-7603 is 16K-chip; 210-7803 is 64K-chip.

-----  
If Memory PCA type is 210-7603:

UJ-3115	VS-16F to VS-32F (Will receive (2) 210-7803-2A) (Must return (2) 210-7603-1A US ONLY)	\$ 6,000	\$ 1,000	\$ 100
UJ-3116	VS-24F to VS-32F (Will receive (2) 210-7803-2A) (Must return (4) 210-7603-1A US ONLY)	3,000	1,000	100
UJ-3120	Memory Upgrade 1MB to 2MB (Will receive (2) 210-7803-4A) (Must return (4) 210-7603-1A US ONLY)	12,000	1,000	100

NOTE: All orders for add-ons and upgrade equipment MUST include the work order numbers and serial numbers of the system components involved.

UPGRADE JOB #	DESCRIPTION	PURCHASE PRICE	-----R E N T A L-----	
			SINGLE CHARGE	OR MONTHLY 1 YEAR

The purchase/rental charges listed include any applicable difference in prices. For purchase systems the incremental maintenance charge is also due.

VS100 MEMORY UPGRADES

UJ-3117	VS-40F to VS-64F (Will receive (2) 210-7803-4A) (Must return (6) 210-7603-1A US ONLY)	\$ 9,000	\$ 1,000	\$ 100
UJ-3118	VS-48F to VS-64F (Will receive (2) 210-7803-4A) (Must return (6) 210-7603-1A US ONLY)	6,000	1,000	100
UJ-3119	VS-56F to VS-64F (Will receive (2) 210-7803-4A) (Must return (8) 210-7603-1A US ONLY)	3,000	1,000	100
UJ-3170	Memory Upgrade 1MB to 3MB (Will receive (2) 210-7803-4A) and (2) 210-7803-2A) (Must return (4) 210-7603-1A US ONLY)	24,000	1,000	100
UJ-3121	Memory Upgrade 2MB to 3MB (Will receive (2) 210-7803-4A) and (2) 210-7803-2A) (Must return (8) 210-7603-1A US ONLY)	12,000	1,000	100
UJ-3171	Memory Upgrade 2MB to 4MB (Will receive (4) 210-7803-4A) (Must return (8) 210-7603-1A US ONLY)	24,000	1,000	100

If the installation has a 2MB or greater VS100 and Memory PCA type is 210-7803, then for each 1MB or 2MB desired:

UJ-3172	Memory Upgrade 3MB to 4MB Memory Upgrade 5MB to 6MB Memory Upgrade 7MB to 8MB (Will receive (2) 210-7803-4A) (Must return (2) 210-7803-2A US ONLY)	12,000	1,000	100
UJ-3173	Memory Upgrade 2MB to 3MB Memory Upgrade 4MB to 5MB Memory Upgrade 6MB to 7MB (Will receive (2) 210-7803-2A)	12,000	1,000	100

NOTE: All orders for add-ons and upgrade equipment MUST include the work order numbers and serial numbers of the system components involved.





UPGRADE JOB #	DESCRIPTION	PURCHASE PRICE	-----R E N T A L-----	
			SINGLE CHARGE	OR MONTHLY 1 YEAR

The purchase/rental charges listed include any applicable difference in prices. For purchase systems the incremental maintenance charge is also due.

**VS100 MEMORY UPGRADES**

If the installation has a 2MB or greater VS100 and Memory PCA type is 210-7803, then for each 1MB or 2MB desired:

UJ-3174	Memory Upgrade 3MB to 5MB Memory Upgrade 5MB to 7MB (Will receive (2) 210-7803-4A) (Place 210-7803-2A in last)	\$ 24,000	\$ 1,000	\$ 100
UJ-3175	Memory Upgrade 2MB to 4MB Memory Upgrade 4MB to 6MB Memory Upgrade 6MB to 8MB (Will receive (2) 210-7803-4A)	24,000	1,000	100

COMPANY CONFIDENTIAL  
 VS100

NOTE: All orders for add-ons and upgrade equipment MUST include the work order numbers and serial numbers of the system components involved.

MODEL NUMBER	DESCRIPTION	PURCHASE PRICE	MONTHLY MAINTENANCE	-----MONTHLY RENTAL PRICES-----			
				1 YEAR	2 YEAR	3 YEAR	5 YEAR

VS300 CENTRAL PROCESSING UNITS

STANDARD TRADE-IN CREDITS APPLY TO THE VS100 TOP'S AS WELL AS THE CPU.

Consists of main memory and a chassis capable of accommodating fifteen (15) IOCs. One System Bus Interface whic provides an interface for fifteen (15) IOCs is standard. Operating system, assembler, and Remote Administration are standard. All systems include a support control unit with workstation, keyboard and 5 1/4" DP/MP archiving diskette, 32 port serial IOC, and Wang supplied Modem for Remote Diagnostic purposes only. Only serial devices may be attached to the system through an appropriate IOC.

VS300-4	4096KB Main Memory	\$170,000	\$ 976*	\$ 9,350	\$ 8,670	\$ 7,480	\$ 6,800
VS300-8	8192KB Main Memory	202,000	1,176*	11,110	10,302	8,888	8,080
VS300-12	12,288KB Main Memory	234,000	1,376*	12,870	11,934	10,296	9,360
VS300-16	16,384KB Main Memory	266,000	1,576*	14,630	13,566	11,704	10,640

SYSTEM EXPANSION (VS300 MODELS ONLY)

VS300-CC	Cable Concentrator Supporting 64 Serial IO Connection Ports	\$ 2,000	N/A	\$ 110	\$ 102	\$ 88	\$ 80
VS300-FPU	Floating Point Unit	10,000	80	550	510	440	400
VS300-BB	Battery Backup	7,000	70	385	357	308	280
VS300-RD	Customer Engineering Support Without Remote Diagnostics <sup>1</sup>	N/A	125	N/A	N/A	N/A	N/A
VS-6550	1 Line Internal TC Processor (Requires one (1) Serial Port Per Line)	2,200	20	121	113	97	88

<sup>1</sup>Maintenance prices reflect systems with Remote Diagnostics. A surcharge of \$125 Maintenance/month (VS300-RD<sup>1</sup>) will be billed for all systems without Remote Diagnostics.

NOTE: All orders for add-ons and upgrade equipment MUST include the work order numbers and serial numbers of the system components involved.

VS/ 3 - 19

COMPANY CONFIDENTIAL  
REPLACES: 02/01/84  
EFFECTIVE: 05/01/84

VS

VS

MODEL NUMBER	DESCRIPTION	PURCHASE PRICE	MONTHLY MAINTENANCE	-----MONTHLY RENTAL PRICES-----				
				1 YEAR	2 YEAR	3 YEAR	5 YEAR	

VS300 IOCsSERIAL WORKSTATIONS, PRINTERS

The maximum distance for serial devices from the CPU (IOC) is 2000 feet/609 meters. A 25 foot/7.6 meter cable is shipped with each serial peripheral device. Cable lengths MUST BE submitted with the system/peripheral order.

23V97	VS300 IOC for serial devices. Provides up to 32 serial ports	\$ 5,000	\$ 69	\$ 275	\$ 255	\$ 220	200
-------	--	----------	-------	--------	--------	--------	-----

DATA COMMUNICATIONS

The maximum distance of a communications line from the CPU (IOC) is 50 feet/15.2 meters. A 25 foot/7.6 meter cable with a RS-232 interface is provided at no charge. The maximum length 50 feet/15.3 meters is available as a substitute for the standard 25 foot/7.6 meter cable. Cable lengths MUST BE submitted with the system/peripheral order.

23V96	VS300 Multi-line TC IOC. Provides up to sixteen (16) TC lines.	\$ 10,000	\$ 152	\$ 550	\$ 510	\$ 440	400
-------	--	-----------	--------	--------	--------	--------	-----

TAPE DRIVE

23V95-1	VS300 IOC for Magnetic Tape Drive. Controls up to four 2209V series Tape Drives.	\$ 4,500	\$ 32	\$ 248	\$ 230	\$ 198	180
23V95-2	VS300 IOC for 6250 Magnetic Tape Drive. Controls up to four 2219V series Tape Drives.	5,500	42	303	281	242	220

DISK DRIVE

Controls up to four models of any supported disk drives in any combination. Supports: 2280V-3; 2265V-1; 2265V-2; 2265V-3; 2267V-1; 2375V-1. Supports all available disk switches: SM04; SM04-1; SM04-3. Maximum of eight (8) disk IOCs on VS300. (Refer to configuration guide)

23V98-1	1 Port Disk IOC, for VS300.	\$ 7,500	\$ 62	\$ 413	\$ 383	\$ 330	300
23V98-2	2 Port Disk IOC, for VS300.	8,500	77	468	434	374	340
23V98-3	3 Port Disk IOC, for VS300.	9,500	92	523	485	418	380
23V98-4	4 Port Disk IOC, for VS300.	10,500	107	578	536	462	420

NOTE: All orders for add-ons and upgrade equipment MUST include the work order numbers and serial numbers of the system components involved.

VS/ 3 - 20

COMPANY CONFIDENTIAL  
REPLACES: 02/01/84  
EFFECTIVE: 05/01/84

UPGRADE JOB #	DESCRIPTION	PURCHASE PRICE	-----R E N T A L-----	
			SINGLE CHARGE	OR MONTHLY 1 YEAR

The purchase/rental charges listed include any applicable difference in prices. For purchase systems the incremental maintenance charge is also due.

DISK DRIVE UPGRADES

UJ-3288	23V98-1 to 23V98-2	\$ 1,500	\$ 150	\$ 15
UJ-3289	23V98-1 to 23V98-3	3,000	300	30
UJ-3290	23V98-1 to 23V98-4	4,500	450	45
UJ-3291	23V98-2 to 23V98-3	1,500	150	15
UJ-3292	23V98-2 to 23V98-4	3,000	300	30
UJ-3293	23V98-3 to 23V98-4	1,500	150	15

VS300 MEMORY UPGRADES

UJ-3283	Memory Upgrade 4MB to 8MB	\$ 40,000	\$ 1,000	\$ 100
UJ-3284	Memory Upgrade 8MB to 12MB	40,000	1,000	100
UJ-3285	Memory Upgrade 12MB to 16MB	40,000	1,000	100

NOTE: All orders for add-ons and upgrade equipment MUST include the work order numbers and serial numbers of the system components involved.

VS/ 3 - 21

COMPANY CONFIDENTIAL  
REPLACES: 02/01/84  
EFFECTIVE: 05/01/84

VS

MODEL NUMBER	DESCRIPTION	PURCHASE PRICE	MONTHLY MAINTENANCE	-----MONTHLY RENTAL PRICES-----			
				1 YEAR	2 YEAR	3 YEAR	5 YEAR

WILS™ - WANG INTERACTIVE LEARNING SYSTEM

WILS orders that include any Wang hardware other than Telecommunications Cables must be submitted to Order Processing. Orders that include only WILS items (the WILS Programs, the Telecommunications Cables and/or the Sony Videodisc Player) must be submitted to the Supplies Division. Orders for component parts of the WILS Programs must also be submitted to the Supplies Division.

WILS WORD PROCESSING PROGRAM

WILS-VS/IIIS	Wang Interactive Learning System™ for VS/IIIS (200-1042) Purchase price includes software license fee 5 Videodiscs 6 VS/IIIS Software Diskettes 15 Standard Numeric Keypad Replacement Keys 1 Keypad Replacement Tool 1 Numeric Keypad Cover 1 Word Processing Learner's Guide 1 Word Processing Program Administrator's Guide	\$ 5,000	N/A	N/A	N/A	N/A	N/A
--------------	--	----------	-----	-----	-----	-----	-----

PARTS

VIDEODISCS

725-2795	WILS™ WP Disc 1	1,000	N/A	N/A	N/A	N/A	N/A
725-2796	WILS™ WP Disc 2	1,000	N/A	N/A	N/A	N/A	N/A
725-2797	WILS™ WP Disc 3	1,000	N/A	N/A	N/A	N/A	N/A
725-2798	WILS™ WP Disc 4	1,000	N/A	N/A	N/A	N/A	N/A
725-2799	WILS™ WP Disc 5	1,000	N/A	N/A	N/A	N/A	N/A

MODEL NUMBER	DESCRIPTION	INITIAL LICENSE FEE	MONTHLY LICENSE FEE	-----MONTHLY RENTAL PRICES-----			
				1 YEAR	2 YEAR	3 YEAR	5 YEAR

SOFTWARE DISKETTES

195-2554-3	Wang Interactive Learning System™ Software for VS/IIIS (6 VS/IIIS Diskettes)	500	N/A	N/A	N/A	N/A	N/A
------------	--	-----	-----	-----	-----	-----	-----

MODEL NUMBER	DESCRIPTION	PURCHASE PRICE	MONTHLY MAINTENANCE	-----MONTHLY RENTAL PRICES-----			
				1 YEAR	2 YEAR	3 YEAR	5 YEAR

WP GUIDES

700-8400	WILS™ WP Learner's Guide	50	N/A	N/A	N/A	N/A	N/A
700-8401	WILS™ WP Program Administrator's Guide	25	N/A	N/A	N/A	N/A	N/A

NOTE: All orders for add-ons and upgrade equipment MUST include the work order numbers and serial numbers of the system components involved.



MODEL NUMBER	DESCRIPTION	PURCHASE PRICE	MONTHLY MAINTENANCE	-----MONTHLY RENTAL PRICES-----				
				1 YEAR	2 YEAR	3 YEAR	5 YEAR	

WILS GLOSSARY PROGRAM

WILS-GL-PROGRAM	Wang Interactive Learning System™ Glossary Program (P/N 200-1061) Purchase price includes software license fee 3 Videodiscs 5 OIS Software Diskettes (8" media) 5 OIS Software Diskettes (5 1/4" media) 4 VS Software Diskettes (8" media) 15 Standard Numeric Keypad Replacement Keys 9 Numeric Keypad Universal Replacement Keys 1 Keypad Replacement Tool 1 Standard Numeric Keypad Cover 1 Universal Numeric Keypad Cover 1 Glossary Program Learner's Guide 1 WILS™ Administrator's Guide	\$ 2,000	N/A	N/A	N/A	N/A	N/A
-----------------	--	----------	-----	-----	-----	-----	-----

PARTS

VIDEODISCS

WILS-GL-DISC5	WILS™ Glossary Videodisc (P/N 200-1062)	2,100	N/A	N/A	N/A	N/A	N/A
WILS-GL-DISC1	WILS™ Glossary Videodisc 1 (P/N 725-2856)	700	N/A	N/A	N/A	N/A	N/A
WILS-GL-DISC2	WILS™ Glossary Videodisc 2 (P/N 725-2857)	700	N/A	N/A	N/A	N/A	N/A
WILS-GL-DISC3	WILS™ Glossary Videodisc 3 (P/N 725-2858)	700	N/A	N/A	N/A	N/A	N/A

NOTE: All orders for add-ons and upgrade equipment MUST include the work order numbers and serial numbers of the system components involved.

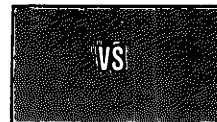

MODEL NUMBER	DESCRIPTION	INITIAL LICENSE FEE	MONTHLY LICENSE FEE	-----MONTHLY RENTAL PRICES-----			
				1 YEAR	2 YEAR	3 YEAR	5 YEAR

WILS GLOSSARY PROGRAM (continued)SOFTWARE DISKETTES

WILS-GL-DIS-SM	Glossary Software-DIS 8" (P/N 195-2903-3)	\$ 200	N/A	N/A	N/A	N/A	N/A
WILS-GL-DIS-SM9	Glossary Software-DIS 5 1/4" (P/N 195-2903-9)	200	N/A	N/A	N/A	N/A	N/A
WILS-GL-VS-SM	Glossary Software-VS/IIS 8" (P/N 195-2904-3)	200	N/A	N/A	N/A	N/A	N/A
MODEL NUMBER	DESCRIPTION	200 PURCHASE PRICE	N/A MONTHLY MAINTENANCE	-----MONTHLY RENTAL PRICES-----			
				1 YEAR	2 YEAR	3 YEAR	5 YEAR

HP GUIDES

WILS-GL-LEARNER	WILS™ Glossary Program Learner's Guide (P/N 700-8703)	50	N/A	N/A	N/A	N/A	N/A
WILS-ADMIN	WILS™ Administrator's Guide (P/N 700-8401A)	25	N/A	N/A	N/A	N/A	N/A

COMPONENT PARTS FOR WILS WORD PROCESSING AND GLOSSARY PROGRAMSKEYCAPS/KEYPAD COVER

WILS-STDKEYS	WILS™ Keycaps for standard numeric keypad (P/N 200-4057-Q6)	\$ 15	N/A	N/A	N/A	N/A	N/A
WILS-UNIKEYS	WILS™ Keycaps for universal numeric keypad (P/N 200-4101-Q6)	15	N/A	N/A	N/A	N/A	N/A
WILS-PULLER	WILS™ Keycaps Replacement Tool (P/N 725-2806)	15	N/A	N/A	N/A	N/A	N/A
WILS-STDCOVER	WILS™ Standard Numeric Keypad Cover (P/N 449-0745)	10	N/A	N/A	N/A	N/A	N/A
WILS-UNICOVER	WILS™ Universal Numeric Keypad Cover (P/N 449-0846)	10	N/A	N/A	N/A	N/A	N/A

SONY PLAYER

725-0141	SONY LDP1000A Video Disc Play- er	2,600	N/A	N/A	N/A	N/A	N/A
----------	--------------------------------------	-------	-----	-----	-----	-----	-----

NOTE: The Sony Video Disc Player is warranted by the Sony Corporation.

NOTE: All orders for add-ons and upgrade equipment MUST include the work order numbers and serial numbers of the system components involved.

MODEL NUMBER	DESCRIPTION	INITIAL LICENSE FEE	MONTHLY SUPPORT PLAN CHARGE	MONTHLY RENTAL PRICES			
				1 YEAR	2 YEAR	3 YEAR	5 YEAR

**VS SOFTWARE**

Assembler is included with all CPU's at no charge. Effective September 1, 1983, all Compilers are unbundled from CPU's, except where included in defined PACKAGES.

QUANTITY ORDERED	DISCOUNT
1 - 2	0%
3 - 5	10%
6 - 10	20%
11 - 20	30%
OVER 20	40%

NOTE: THIS DISCOUNT SCHEDULE APPLIES TO ALL VS SOFTWARE. DISCOUNTS DO NOT APPLY TO MONTHLY FEES.

Discounts are allowed for quantity purchases (sales only; no rentals except as noted on exception basis). Orders must be submitted on a single purchase order, delivery may be to multiple delivery points, but must be within six (6) months of initial order. Quantity discounts are applied per model number not on an aggregate basis except as noted on an exception basis. Products for which Wang publishes multi-unit discounts shall receive the higher of the applicable published multi-unit quantity discount, or the Annual Volume Agreement discount, but not both.

**MULTIPLE SYSTEMS LICENSE** - Customers who purchase a Wang Compiler at full price can purchase the right to reproduce the software and documentation for other VS systems that are owned by the customer, for 60% of the INITIAL LICENSE FEE for each copy.

NOTE: The Price quoted below as "MONTHLY STANDARD SUPPORT FEE" refers to Wang "Standard Support" Option. "Central Site Support" Option is available at 40% of the "MONTHLY STANDARD SUPPORT FEE", see CE Section for a complete description of compiler support options.

Billable support is charged at the current rate of \$100 per hour (two hour minimum). Compiler software updates and documentation may be purchased for \$350 per update.

**LANGUAGES**

195-2105-X	COBOL Compiler	\$ 7,000	N/A	\$ 385	\$ 357	\$ 308	280
195-2105-MSL	COBOL Multiple System License	4,200	N/A	N/A	N/A	N/A	N/A
195-2105-STD	COBOL Standard Software Support	N/A	59	N/A	N/A	N/A	N/A
195-2105-CSS	COBOL Central Site Support	N/A	24	N/A	N/A	N/A	N/A
195-2106-X	RPGII Compiler	6,000	N/A	330	306	264	240
195-2106-MSL	RPGII Multiple System License	3,600	N/A	N/A	N/A	N/A	N/A
195-2106-STD	RPGII Standard Software Support	N/A	50	N/A	N/A	N/A	N/A

NOTE: X = ALL ORDERS MUST SPECIFY THE MEDIA TYPE BY THE APPROPRIATE MODEL NUMBER SUFFIX (I.E. -3 = SINGLE SIDED SINGLE DENSITY (SSSD) FLOPPY ON VS80;  
 -5 = DUAL SIDED DOUBLE DENSITY (DSDD) ON VS25/VS45, VS85/VS90/VS100/VS300.  
 -7 = MAGNETIC TAPE (Only available for PL/I and RPG conversion Packages)

NOTE: All orders for add-ons and upgrade equipment MUST include the work order numbers and serial numbers of the system components involved.

COMPANY CONFIDENTIAL  
 REPLACES: 02/01/84  
 EFFECTIVE: 05/01/84



MODEL NUMBER	DESCRIPTION	INITIAL LICENSE FEE	MONTHLY SUPPORT PLAN CHARGE	-----MONTHLY RENTAL PRICES-----			
				1 YEAR	2 YEAR	3 YEAR	5 YEAR
195-2106-CSS	RPGII Central Site Support	N/A	\$ 20	N/A	N/A	N/A	N/A
195-2104-X	BASIC Compiler	6,000	N/A	330	306	264	240
195-2104-MSL	BASIC Multiple System License	3,600	N/A	N/A	N/A	N/A	N/A
195-2104-STD	BASIC Standard Software Support	N/A	50	N/A	N/A	N/A	N/A
195-2104-CSS	BASIC Central Site Support	N/A	20	N/A	N/A	N/A	N/A
195-2087-X	FORTRAN 77 Compiler	7,000	N/A	385	357	308	280
195-2087-MSL	Fortran 77 Multiple System License	4,200	N/A	N/A	N/A	N/A	N/A
195-2087-STD	Fortran 77 Standard Software Support	N/A	59	N/A	N/A	N/A	N/A
195-2087-CSS	Fortran 77 Central Site Support	N/A	24	N/A	N/A	N/A	N/A
195-2086-X	PL/I Compiler	6,000	N/A	330	306	264	240
195-2086-MSL	PL/I Multiple System License	3,600	N/A	N/A	N/A	N/A	N/A
195-2086-STD	PL/I Standard Software Support	N/A	50	N/A	N/A	N/A	N/A
195-2086-CSS	PL/I Central Site Support	N/A	20	N/A	N/A	N/A	N/A

- NOTE: 1. License fee schedules apply to all nonpackaged purchase or rental transactions that include a compiler, except for packaged systems which include one compiler in the prices quoted.
2. Initial license fee schedules apply to the second and subsequent compilers ordered with a packaged system.
3. Monthly support plan charges apply whenever customers elect monthly support plan coverage. When ordered, monthly support plan coverage for each compiler should be entered as a separate, billable, line item on the ordering supplement.
4. Monthly support charges for compilers ordered with VS purchased systems should be added to monthly maintenance charges.
5. Monthly support charges for compilers ordered with VS rental systems should be added to monthly rental charges.

195-2262-7	RPGII Conversion Package (9 Track Tape)	750	N/A	N/A	N/A	N/A	N/A
195-2262-X	RPGII Conversion Package (Diskettes)	750	N/A	N/A	N/A	N/A	N/A

NOTE: X = ALL ORDERS MUST SPECIFY THE MEDIA TYPE BY THE APPROPRIATE MODEL NUMBER SUFFIX  
(I.E. -3 = SINGLE SIDED SINGLE DENSITY (SSSD) FLOPPY ON VS80;  
-5 = DUAL SIDED DOUBLE DENSITY (DSDD) ON VS25/VS45, VS85/VS90/VS100/VS300.  
-7 = MAGNETIC TAPE (Only available for PL/I and RPG conversion Packages)

NOTE: All orders for add-ons and upgrade equipment MUST include the work order numbers and serial numbers of the system components involved.

UPGRADE  
JOB #

DESCRIPTION

PURCHASE  
PRICE

-----R E N T A L-----  
SINGLE OR MONTHLY  
CHARGE 1 YEAR

The purchase/rental charges listed include any applicable difference in prices. For purchase systems the incremental maintenance charge is also due.

FORTRAN 66 UPGRADE

UJ-3241-X	FORTRAN 66 to FORTRAN 77	\$ 2,500	\$ 500	\$ 50
-----------	--------------------------	----------	--------	-------

MODEL  
NUMBER

DESCRIPTION

PURCHASE  
PRICE

MONTHLY  
MAINTENANCE

-----M O N T H L Y R E N T A L P R I C E S-----  
1 YEAR 2 YEAR 3 YEAR 5 YEAR

FORTRAN LANGUAGE BOARD

No Charge Item if purchased with 195-2122-X, 195-2086-X Compilers.

177-7086	Language Board (VS-80 Only Re- quired for FORTRAN 66 optional for PL/1)	\$ 2,000	N/A	\$ 110	\$ 102	\$ 88	\$ 80
----------	---	----------	-----	--------	--------	-------	-------

VS MULTI-STATION

195-2740-X	VS MULTI-STATION Software	\$ 3,000	\$ 25	\$ 165	\$ 153	\$ 132	\$ 120
------------	---------------------------	----------	-------	--------	--------	--------	--------

NOTE: X = ALL ORDERS MUST SPECIFY THE MEDIA TYPE BY THE APPROPRIATE MODEL NUMBER SUFFIX  
(I.E. -3 = SINGLE SIDED SINGLE DENSITY (SSSD) FLOPPY ON VS80;  
-5 = DUAL SIDED DOUBLE DENSITY (DSDD) ON VS28/VS45, VS85/VS90/VS100/VS300.  
-7 = MAGNETIC TAPE (Only available for PL/1 and RPG conversion Packages)

NOTE: All orders for add-ons and upgrade equipment MUST include the work order numbers and serial numbers of the system components involved.

VS/ 3 - 27

COMPANY CONFIDENTIAL  
REPLACES: 02/01/84  
EFFECTIVE: 05/01/84

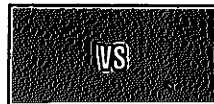



MODEL NUMBER	DESCRIPTION	INITIAL LICENSE FEE	MONTHLY LICENSE FEE	-----MONTHLY RENTAL PRICES-----			
				1 YEAR	2 YEAR	3 YEAR	5 YEAR

UVS (UNIX\* on VS)

\*UNIX IS A REGISTERED TRADEMARK OF BELL LABS.

195-2707-X	UVS (UNIX on VS) for 1 to 16 users	\$ 15,000	N/A	N/A	N/A	N/A	N/A
195-2708-X	UVS (UNIX on VS) for 17 to 32 users	25,000	N/A	N/A	N/A	N/A	N/A
195-2709-X	UVS (UNIX on VS) for 33 to 64 users	35,000	N/A	N/A	N/A	N/A	N/A
195-2710-X	UVS (UNIX on VS) for 65 to 128 users	45,000	N/A	N/A	N/A	N/A	N/A

MODEL NUMBER	DESCRIPTION	MULTIPLE SYSTEM LICENSE FEE	MONTHLY LICENSE FEE	-----MONTHLY RENTAL PRICES-----			
				1 YEAR	2 YEAR	3 YEAR	5 YEAR

NOTE: THE MULTIPLE SYSTEMS LICENSE FEE IS CHARGED ON A PER COPY BASIS. SEE GENERAL INFORMATION SECTION FOR MORE DETAIL DESCRIPTION.

THE FOLLOWING UVS MULTIPLE SYSTEM LICENSE, STANDARD SOFTWARE SUPPORT AND CENTRAL SITE SUPPORT ARE NOT QUANTITY DISCOUNTED.

MULTIPLE SYSTEMS LICENSE

195-2707-MSL	UVS (UNIX on VS) for 1 to 16 Users Multiple System License	\$ 9,000	N/A	N/A	N/A	N/A	N/A
195-2708-MSL	UVS (UNIX on VS) for 17 to 32 Users Multiple System License	15,000	N/A	N/A	N/A	N/A	N/A
195-2709-MSL	UVS (UNIX on VS) for 33 to 64 Users Multiple System License	21,000	N/A	N/A	N/A	N/A	N/A
195-2710-MSL	UVS (UNIX on VS) for 65 to 128 Users Multiple System License	27,000	N/A	N/A	N/A	N/A	N/A

NOTE: X = ALL ORDERS MUST SPECIFY THE MEDIA TYPE BY THE APPROPRIATE MODEL NUMBER SUFFIX (I.E. -3 = SINGLE SIDED SINGLE DENSITY (SSSD) FLOPPY ON VS80; -5 = DUAL SIDED DOUBLE DENSITY (DSDD) ON VS25/VS45, VS85/VS90/VS100/VS300. -7 = MAGNETIC TAPE (Only available for PL/I and RPG conversion Packages)

NOTE: All orders for add-ons and upgrade equipment MUST include the work order numbers and serial numbers of the system components involved.

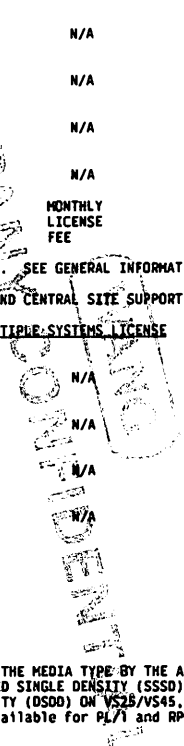

MODEL NUMBER	DESCRIPTION	INITIAL LICENSE FEE	STANDARD MONTHLY SUPPORT FEE	-----MONTHLY RENTAL PRICES-----			
				1 YEAR	2 YEAR	3 YEAR	5 YEAR

STANDARD SOFTWARE SUPPORT

NOTE: SEE GENERAL INFORMATION SECTION FOR MORE DETAIL DESCRIPTION.

195-2707-STD	UVS (UNIX on VS) for 1 to 16 Users Standard Software Support	N/A	\$ 188	N/A	N/A	N/A	N/A
195-2708-STD	UVS (UNIX on VS) for 17 to 32 Users Standard Software Support	N/A	313	N/A	N/A	N/A	N/A
195-2709-STD	UVS (UNIX on VS) for 1 to 16 users Standard Software Support	N/A	438	N/A	N/A	N/A	N/A
195-2710-STD	UVS (UNIX on VS) for 65 to 128 Users Standard Software Support	N/A	563	N/A	N/A	N/A	N/A

MODEL NUMBER	DESCRIPTION	INITIAL LICENSE FEE	CENTRAL SITE SUPPORT FEE	-----MONTHLY RENTAL PRICES-----			
				1 YEAR	2 YEAR	3 YEAR	5 YEAR

CENTRAL SITE SUPPORT (SECONDARY SITES) OPTIONS

195-1707-CSS	UVS (UNIX on VS) for 1 to 16 Users Central Site Support	N/A	\$ 76	N/A	N/A	N/A	N/A
195-2708-CSS	UVS (UNIX on VS) for 17 to 32 Users Central Site Support	N/A	126	N/A	N/A	N/A	N/A
195-2709-CSS	UVS (UNIX on VS) for 33 to 64 Users Central Site Support	N/A	175	N/A	N/A	N/A	N/A
195-2710-CSS	UVS (UNIX on VS) for 65 to 128 Users Central Site Support	N/A	226	N/A	N/A	N/A	N/A

UPGRADE JOB #	DESCRIPTION	PURCHASE PRICE	-----R E N T A L-----	
			SINGLE CHARGE	OR MONTHLY 1 YEAR

The purchase charges listed include any applicable difference in prices. For purchase systems the incremental maintenance charge is also due.

UVS UPGRADES

UJ-3212	From 1 - 16 Users to 17 - 32 Users	\$ 10,000	N/A	N/A
---------	------------------------------------	-----------	-----	-----

NOTE: X = ALL ORDERS MUST SPECIFY THE MEDIA TYPE BY THE APPROPRIATE MODEL NUMBER SUFFIX (I.E. -3 = SINGLE SIDED SINGLE DENSITY (SSSD) FLOPPY ON VS80;  
 -5 = DUAL SIDED DOUBLE DENSITY (DSDD) ON VS25/VS45, VS85/VS90/VS100/VS300.  
 -7 = MAGNETIC TAPE (Only available for PL/1 and RPG conversion Packages)

NOTE: All orders for add-ons and upgrade equipment MUST include the work order numbers and serial numbers of the system components involved.





UPGRADE JOB #	DESCRIPTION	PURCHASE PRICE	-----R E N T A L-----	
			SINGLE CHARGE	OR MONTHLY 1 YEAR

The purchase/rental charges listed include any applicable difference in prices. For purchase systems the incremental maintenance charge is also due.

VS UPGRADES (continued)

UJ-3213	From 1 - 16 Users To 33 - 64 Users	\$ 20,000	N/A	N/A
UJ-3214	From 1 - 16 Users To 65 - 128 Users	30,000	N/A	N/A
UJ-3215	From 17 - 32 Users To 33 - 64 Users	10,000	N/A	N/A
UJ-3216	From 17 - 32 Users To 65 - 128 Users	20,000	N/A	N/A
UJ-3217	From 34 - 64 Users To 65 - 128 Users	10,000	N/A	N/A

MODEL NUMBER	DESCRIPTION	INITIAL LICENSE FEE	MONTHLY LICENSE FEE	-----MONTHLY RENTAL PRICES-----			
				1 YEAR	2 YEAR	3 YEAR	5 YEAR

DOCUMENTATION FOR VS INFO FACILITY

195-2282-X	VS INFO/BASIC Language Refer- ence	\$ 250	\$ 3	N/A	N/A	N/A	N/A
195-2283-X	VS INFO/PL/1 Language Refer- ence	250	3	N/A	N/A	N/A	N/A
195-2284-X	VS INFO/FORTRAN 66 Language Reference	250	3	N/A	N/A	N/A	N/A
195-2285-X	VS INFO/COBOL Language Refer- ence	250	3	N/A	N/A	N/A	N/A
195-2286-X	VS INFO/ASSEMBLER Language Reference	250	3	N/A	N/A	N/A	N/A
195-2287-X	VS INFO/Operating System Ser- vice	250	3	N/A	N/A	N/A	N/A
195-2288-X	VS INFO/Principle of Operations	250	3	N/A	N/A	N/A	N/A

NOTE: X = ALL ORDERS MUST SPECIFY THE MEDIA TYPE BY THE APPROPRIATE MODEL NUMBER SUFFIX  
(I.E. -3 = SINGLE SIDED SINGLE DENSITY (SSSD) FLOPPY ON VS80;  
-5 = DUAL SIDED DOUBLE DENSITY (DSDD) ON VS25/VS45, VS85/VS90/VS100/VS300.  
-7 = MAGNETIC TAPE (Only available for PL/1 and RPG conversion Packages)

NOTE: All orders for add-ons and upgrade equipment MUST include the work order numbers and serial numbers of the system components involved.



MODEL NUMBER	DESCRIPTION	INITIAL LICENSE FEE	MONTHLY LICENSE FEE	-----MONTHLY RENTAL PRICES-----			
				1 YEAR	2 YEAR	3 YEAR	5 YEAR

DOCUMENTATION FOR VS INFO FACILITY (continued)

195-2289-X	VS INFO/Programmer's Package. (Includes Programmer's Introduction, Procedure Language Reference and Program Development Tools)	\$ 250	\$ 3	N/A	N/A	N/A	N/A
195-2322-X	VS INFO/System Utilities	250	3	N/A	N/A	N/A	N/A
195-2323-X	VS INFO/File Management Utilities	250	3	N/A	N/A	N/A	N/A

NOTE: X = ALL ORDERS MUST SPECIFY THE MEDIA TYPE BY THE APPROPRIATE MODEL NUMBER SUFFIX  
(I.E. -3 = SINGLE SIDED SINGLE DENSITY (SSSD) FLOPPY ON VS80;  
-5 = DUAL SIDED DOUBLE DENSITY (DSDD) ON VS25/VS45, VS85/VS90/VS100/VS300.  
-7 = MAGNETIC TAPE (Only available for PL/I and RPG conversion Packages)

NOTE: All orders for add-ons and upgrade equipment MUST include the work order numbers and serial numbers of the system components involved.



VS:

MODEL NUMBER	DESCRIPTION	INITIAL LICENSE FEE	MONTHLY LICENSE FEE	-----MONTHLY RENTAL PRICES-----			
				1 YEAR	2 YEAR	3 YEAR	5 YEAR

WANG VS TOTAL

Business Systems (VS46, VS80, VS85, VS90, VS100, VS300)

195-2667-X	Data base Management System (Full Use)	\$ 20,000	\$ 250	N/A	N/A	N/A	N/A
195-2668-X	Data Base Management System (Limited Use)	16,000	200	N/A	N/A	N/A	N/A

Users of TOTAL Version 1 will have to pay the monthly maintenance charge associated with TOTAL 2

THE STANDARD VS SOFTWARE DISCOUNT POLICY APPLIES TO WANG VS TOTAL

UPGRADE JOB #	DESCRIPTION	PURCHASE PRICE	-----RENTAL-----	
			SINGLE OR MONTHLY CHARGE	1 YEAR

The purchase/rental charges listed include any applicable difference in prices. For purchase systems the incremental maintenance charge is also due.

WANG VS TOTAL UPGRADES

UJ-3206-X	TOTAL Version 1 (Full Use) to TOTAL Version 2 (Full Use)	N/A	N/A	N/A
UJ-3207-X	TOTAL Version 1 (Limited Use) to TOTAL Version 2 (Limited Use)	N/A	N/A	N/A
UJ-3208-X	TOTAL Version 2 (Limited Use) to TOTAL Version 2 (Full Use)	\$ 4,000	N/A	N/A

Full Use versions are for sites that perform program development, modification of TOTAL software and run TOTAL applications.

Limited Use -- "Production Only" versions are for sites that run TOTAL applications. Limited use versions cannot be used to perform program development and modification. No new Data Base development can be performed with Limited Use versions.

Installation/Consultation. These services are available at \$600 per day, plus travel and living expenses. For a first time user the Installation and Consultation normally consists of two days on-site.

ISO Discounts. OEM discounts are not applicable.

NOTE: X = ALL ORDERS MUST SPECIFY THE MEDIA TYPE BY THE APPROPRIATE MODEL NUMBER SUFFIX (I.E. -3 = SINGLE SIDED SINGLE DENSITY (SSSD) FLOPPY ON VS80; -5 = DUAL SIDED DOUBLE DENSITY (DSDD) ON VS25/VS46, VS85/VS90/VS100/VS300. -7 = MAGNETIC TAPE (Only available for PL/1 and RPG conversion Packages)

NOTE: All orders for add-ons and upgrade equipment MUST include the work order numbers and serial numbers of the system components involved.

MODEL NUMBER	DESCRIPTION	INITIAL LICENSE FEE	MONTHLY LICENSE FEE	MONTHLY RENTAL PRICES			
				1 YEAR	2 YEAR	3 YEAR	5 YEAR

**WANG VS T-ASK**

Business Systems (VS45, VS80, VS85, VS90, VS100, VS300)

195-2686-X	VS TOTAL T-ASK (Query and Report)	\$ 10,000	\$ 125	N/A	N/A	N/A	N/A
------------	-----------------------------------	-----------	--------	-----	-----	-----	-----

VS T-ASK operates with the Full and Limited Use Versions of VS TOTAL.

THE STANDARD VS SOFTWARE DISCOUNT POLICY APPLIES TO WANG VS T-ASK.

**PACE**

(PROFESSIONAL APPLICATION CREATION ENVIRONMENT)

NOTE: PACE requires: VS25/45/85/90/100/300; minimum 1 Megabyte main memory. All PACE products require PACE RDBMS (Relational Database Management System)

196-0006-X	PACE PACKAGE PACE RDBMS Application Builder PACE Query PACE Report VS Graphics	\$ 34,000	N/A	\$ 1,870	\$ 1,734	\$ 1,496	\$ 1,360
------------	---	-----------	-----	----------	----------	----------	----------

195-2733-X	PACE RDBMS (Includes: Dictionary, Relational Runtime, Host Language Interface and Pace Manager)	10,000	N/A	550	510	440	400
------------	--	--------	-----	-----	-----	-----	-----

**OPTIONS TO PACE RDBMS**

195-2734-X	APPLICATION BUILDER	\$ 15,000	\$ 125	\$ 825	\$ 765	\$ 660	\$ 600
195-2736-X	PACE QUERY	4,000	N/A	220	204	176	160
195-2737-X	PACE Report	4,000	N/A	220	204	176	160

NOTE: SEE GRAPHICS SOFTWARE SECTION FOR VS GRAPHICS ASSOCIATED WITH PACE

NOTE: X = ALL ORDERS MUST SPECIFY THE MEDIA TYPE BY THE APPROPRIATE MODEL NUMBER SUFFIX (I.E., -3 = SINGLE SIDED SINGLE DENSITY (SSSD) FLOPPY ON VS80; -5 = DUAL SIDED DOUBLE DENSITY (DSDD) ON VS25/VS45, VS85/VS90/VS100/VS300. -7 = MAGNETIC TAPE (Only available for PL/I and RPG conversion Packages)

NOTE: All orders for add-ons and upgrade equipment MUST include the work order numbers and serial numbers of the system components involved.

COMPANY CONFIDENTIAL  
REPLACES: 02/01/84  
EFFECTIVE: 05/01/84





MODEL NUMBER	DESCRIPTION	MULTIPLE SYSTEM LICENSE FEE	MONTHLY LICENSE FEE	-----MONTHLY RENTAL PRICES-----				
				1 YEAR	2 YEAR	3 YEAR	5 YEAR	

NOTE: THE MULTIPLE SYSTEMS LICENSE FEE IS CHARGED ON A PER COPY BASIS. SEE GENERAL INFORMATION SECTION FOR MORE DETAIL DESCRIPTION.

THE FOLLOWING PACE MULTIPLE SYSTEM LICENSE, STANDARD SOFTWARE SUPPORT AND CENTRAL SITE SUPPORT ARE NOT QUANTITY DISCOUNTED.

MULTIPLE SYSTEMS LICENSE

196-0006-MSL	PACE Package Multiple System License	\$ 20,400	N/A	N/A	N/A	N/A	N/A
195-2733-MSL	PACE ROBMS Multiple System License	6,000	N/A	N/A	N/A	N/A	N/A
195-2734-MSL	Application Builder Multiple System License	9,000	N/A	N/A	N/A	N/A	N/A
195-2736-MSL	PACE Query Multiple System License	2,400	N/A	N/A	N/A	N/A	N/A
195-2737-MSL	PACE Report Multiple System License	2,400	N/A	N/A	N/A	N/A	N/A
VS GRAPHICS-MSL	VS Graphics Multiple System License	1,800	N/A	N/A	N/A	N/A	N/A

MODEL NUMBER	DESCRIPTION	INITIAL LICENSE FEE	STANDARD MONTHLY SUPPORT FEE	-----MONTHLY RENTAL PRICES-----				
				1 YEAR	2 YEAR	3 YEAR	5 YEAR	

STANDARD SOFTWARE SUPPORT

NOTE: SEE GENERAL INFORMATION SECTION FOR MORE DETAIL DESCRIPTION.

196-0006-STD	PACE Package Standard Software Support	N/A	\$ 302	N/A	N/A	N/A	N/A
195-2733-STD	PACE ROBMS Standard Software Support	N/A	84	N/A	N/A	N/A	N/A
195-2734-STD	Application Builder Standard Software Support	N/A	125	N/A	N/A	N/A	N/A
195-2736-STD	PACE Query Standard Software Support	N/A	34	N/A	N/A	N/A	N/A

NOTE: X = ALL ORDERS MUST SPECIFY THE MEDIA TYPE BY THE APPROPRIATE MODEL NUMBER SUFFIX  
 (I.E. -3 = SINGLE SIDED SINGLE DENSITY (SSSD) FLOPPY ON VS80;  
 -5 = DUAL SIDED DOUBLE DENSITY (DSDD) ON VS25/VS45, VS85/VS90/VS100/VS300.  
 -7 = MAGNETIC TAPE (Only available for PL/1 and RPG conversion Packages)

NOTE: All orders for add-ons and upgrade equipment MUST include the work order numbers and serial numbers of the system components involved.

MODEL NUMBER	DESCRIPTION	INITIAL LICENSE FEE	STANDARD MONTHLY SUPPORT FEE	-----MONTHLY RENTAL PRICES-----			
				1 YEAR	2 YEAR	3 YEAR	5 YEAR

STANDARD SOFTWARE SUPPORT (continued)

NOTE: SEE GENERAL INFORMATION SECTION FOR MORE DETAIL DESCRIPTION.

195-2737-STO	PACE Report Standard Software Support	N/A	\$ 34	N/A	N/A	N/A	N/A
VS GRAPHICS-STO	VS Graphics Standard Software Support	N/A	25	N/A	N/A	N/A	N/A

MODEL NUMBER	DESCRIPTION	INITIAL LICENSE FEE	CENTRAL SITE SUPPORT FEE	-----MONTHLY RENTAL PRICES-----			
				1 YEAR	2 YEAR	3 YEAR	5 YEAR

CENTRAL SITE SUPPORT (SECONDARY SITES) OPTIONS

196-0006-CSS	PACE Package Central Site Support	N/A	\$ 121	N/A	N/A	N/A	N/A
195-2733-CSS	PACE RDBMS Central Site Support	N/A	34	N/A	N/A	N/A	N/A
195-2734-CSS	Application Builder Central Site Support	N/A	50	N/A	N/A	N/A	N/A
195-2736-CSS	PACE Query Central Site Support	N/A	14	N/A	N/A	N/A	N/A
195-2737-CSS	PACE Report Standard Software Support	N/A	14	N/A	N/A	N/A	N/A
VS GRAPHICS-CSS	VS Graphics Central Site Support	N/A	10	N/A	N/A	N/A	N/A

MODEL NUMBER	DESCRIPTION	INITIAL LICENSE FEE	MONTHLY LICENSE FEE	-----MONTHLY RENTAL PRICES-----			
				1 YEAR	2 YEAR	3 YEAR	5 YEAR

EZQUERY SOFTWARE

195-2304-X	EZQUERY	\$ 4,000	\$ 34	\$ 240	\$ 220	\$ 176	\$ 160
------------	---------	----------	-------	--------	--------	--------	--------

VS/REPORT SOFTWARE

195-2617-X	VS/Report	\$ 4,000	\$ 34	\$ 240	\$ 220	\$ 176	\$ 160
------------	-----------	----------	-------	--------	--------	--------	--------

NOTE: X = ALL ORDERS MUST SPECIFY THE MEDIA TYPE BY THE APPROPRIATE MODEL NUMBER SUFFIX (I.E. -3 = SINGLE SIDED SINGLE DENSITY (SSSD) FLOPPY ON VS80;  
 -5 = DUAL SIDED DOUBLE DENSITY (DSDD) ON VS25/VS45, VS85/VS90/VS100/VS300.  
 -7 = MAGNETIC TAPE (Only available for PL/1 and RPG conversion Packages)

NOTE: All orders for add-ons and upgrade equipment MUST include the work order numbers and serial numbers of the system components involved.

VS/ 3 - 35

COMPANY CONFIDENTIAL  
 REPLACES: 02/01/84  
 EFFECTIVE: 05/01/84



VS

MODEL NUMBER	DESCRIPTION	INITIAL LICENSE FEE	MONTHLY LICENSE FEE	-----MONTHLY RENTAL PRICES-----			
				1 YEAR	2 YEAR	3 YEAR	5 YEAR

COMMUNICATIONS SOFTWARE

A 22V06, 22V26, 25V76 or 6554 is required when ordering any product designated TC.

195-2089-X	TC-3270 Emulation (Not Available on 6554)	\$ 1,500	N/A	\$ 77	\$ 69	\$ 66	60
195-2090-X	TC-2780/3780 Emulation (Not Available on 6554)	1,000	N/A	51	46	44	40
195-2169-X	3274 Model IC Emulation (Not Available on 22V06/22V26)	1,500	N/A	77	69	66	60
195-2170-X	3777 Model 3 Emulation (Not Available on 22V06/22V26)	1,500	N/A	77	69	66	60
195-2185-X	VS/TTY Emulator Facility (Not Available on 6554-X)	1,500	N/A	77	69	66	60
195-2272-X	General Asynchronous Interface (Not Available on 6554-X)	4,000	N/A	204	184	176	160
195-2275-X	Transdata 810 Emulation (Available on 22V06/22V26 ONLY)	1,500	N/A	77	69	66	60
195-2348-X	ICL 7182 Emulation (Available on 22V06/22V26 ONLY)	1,500	N/A	77	69	66	60
195-2826-X	VS HASP EMULATOR (Not available on VS-TC)	2,200	N/A	121	113	97	88

IDS SOFTWARE

THE FOLLOWING IDS SOFTWARE IS NOT QUANTITY DISCOUNTED.

VS-MSNT-IDS-X	IDS VS Transport Interface	\$ 1,000	\$ 9	\$ 55	\$ 51	\$ 44	40
---------------	----------------------------	----------	------	-------	-------	-------	----

NOTE: X = ALL ORDERS MUST SPECIFY THE MEDIA TYPE BY THE APPROPRIATE MODEL NUMBER SUFFIX (I.E. -3 = SINGLE SIDED SINGLE DENSITY (SSSD) FLOPPY ON VS80;  
 -5 = DUAL SIDED DOUBLE DENSITY (DSOD) ON VS26/VS45, VS85/VS90/VS100/VS300.  
 -7 = MAGNETIC TAPE (Only available for PL/1 and RPG conversion Packages)

NOTE: All orders for add-ons and upgrade equipment MUST include the work order numbers and serial numbers of the system components involved.

MODEL NUMBER	DESCRIPTION	INITIAL LICENSE FEE	MONTHLY LICENSE FEE	-----MONTHLY RENTAL PRICES-----			
				1 YEAR	2 YEAR	3 YEAR	5 YEAR

**IDS SOFTWARE (continued)**

THE FOLLOWING DISCOUNT IS A UNIQUE SITE DISCOUNT SCHEDULE THAT APPLIES TO THE BELOW LISTED IDS SOFTWARE ONLY.

NUMBER OF SITES	DISCOUNT
1 - 3	0 %
4 - 9	15 %
10 - 18	25 %
19 +	40 %

Discounts are allowed for quantity purchases (sales only; no rentals except as noted on exception basis). Orders must be submitted on a single purchase order, delivery may be to multiple delivery points, but must be within six (6) months of initial order. Quantity discounts are applied per model number not on an aggregate basic except as noted on an exception basis. Products for which Wang publishes multi-unit discounts shall receive the higher of the applicable published multi-unit quantity discount, or the Annual Volume Agreement discount, but not both.

HOST-WSMS-IDS1	IDS Host Services Level I	\$ 45,500	N/A	N/A	N/A	N/A	N/A
HOST-WSMS-IDS2	IDS Host Services Level II	58,000	N/A	N/A	N/A	N/A	N/A

UPGRADE JOB #	DESCRIPTION	PURCHASE PRICE	-----R E N T A L-----	
			SINGLE OR MONTHLY CHARGE	1 YEAR
<b>IDS UPGRADE</b>				
UJ-3240	IDS Host Service Level I to IDS Host Service Level II	\$ 18,300	N/A	N/A

MODEL NUMBER	DESCRIPTION	INITIAL LICENSE FEE	MONTHLY LICENSE FEE	-----MONTHLY RENTAL PRICES-----			
				1 YEAR	2 YEAR	3 YEAR	5 YEAR

**WANG SYSTEMS NETWORKING SOFTWARE**

VS-WSNT-MP-X	VS Multipoint Primary Transport	\$ 1,500	\$ 13	\$ 83	\$ 77	\$ 66	60
VS-WSNT-MS-X	VS Multipoint Secondary Transport	1,200	10	66	62	53	48
VS-WSNT-PP-X	VS Point-Point Transport	1,500	13	83	77	66	60
VS-WSNT-X25-X	VS X.25 Transport	1,500	13	83	77	66	60
VS-WSNT-WB-X	VS Wang Band Transport	N/A	N/A	N/A	N/A	N/A	N/A

NOTE: X = ALL ORDERS MUST SPECIFY THE MEDIA TYPE BY THE APPROPRIATE MODEL NUMBER SUFFIX (I.E. -3 = SINGLE SIDED SINGLE DENSITY (SSSD) FLOPPY ON VS80;  
 -5 = DUAL SIDED DOUBLE DENSITY (DSDD) ON VS25/VS45, VS85/VS90/VS100/VS300.  
 -7 = MAGNETIC TAPE (Only available for PL/1 and RPG conversion Packages)

NOTE: All orders for add-ons and upgrade equipment MUST include the work order numbers and serial numbers of the system components involved.





MODEL NUMBER	DESCRIPTION	INITIAL LICENSE FEE	MONTHLY LICENSE FEE	-----M O N T H L Y R E N T A L P R I C E S-----			
				1 YEAR	2 YEAR	3 YEAR	5 YEAR

WANG SYSTEMS NETWORKING SOFTWARE (continued)

VS-WSNS-LGN-X	VS Terminal Emulation	\$ 400	\$ 4	\$ 22	\$ 21	\$ 18	16
VS-WSNS-FT-X	VS File Transfer Service	600	5	33	31	27	24
VS-WSNS-VTI-X	VS Virtual Terminal Interface	600	5	33	31	27	24

WORD PROCESSING

195-2078-X	Word Processing (Requires 256KB Memory)	\$ 8,000	\$ 67	\$ 440	\$ 408	\$ 352	320
------------	---	----------	-------	--------	--------	--------	-----

OPTIONAL IIS SOFTWARE

NOTE: WP is required for IIS Software (195-2078-X)

QUANTITY DISCOUNTS ARE AVAILABLE FOR THE PURCHASE OF MULTIPLE COPIES OF EACH SOFTWARE PACKAGE. THE DISCOUNT COVERS THE INITIAL LICENSE FEE. TO QUALIFY, THEY MUST BE ORDERED ON A SINGLE WORK ORDER FOR DELIVERY TO A SINGLE ADDRESS.

IIS-LISTMGHT-X	List Management Software	\$ 2,000	\$ 9	\$ 110	\$ 102	\$ 88	80
IIS-SPELL-X	Spelling Verifier (Requires 256KB Memory)	1,000	120	47	46	44	40
IIS-READ-X	Readability Analysis (Requires 256KB Memory)	3,000	360	141	138	132	120

MODEL NUMBER	DESCRIPTION	INITIAL LICENSE FEE	MONTHLY LICENSE FEE	-----M O N T H L Y R E N T A L P R I C E S-----			
				1 YEAR	2 YEAR	3 YEAR	5 YEAR

EDITOR PACKAGES

IIS-WP-PLUS-X	Optional advance Word Processing package for VS/IIS Systems	\$ 10,000	\$ 84	\$ 550	\$ 510	\$ 440	400
---------------	---	-----------	-------	--------	--------	--------	-----

UPGRADE JOB #	DESCRIPTION	PURCHASE PRICE	-----R E N T A L-----	
			SINGLE OR MONTHLY CHARGE	MONTHLY 1 YEAR
UJ-3249-X	Advanced Word Processing package for VS/IIS System	2,000	400	40

NOTE: X = ALL ORDERS MUST SPECIFY THE MEDIA TYPE BY THE APPROPRIATE MODEL NUMBER SUFFIX (I.E. -3 = SINGLE SIDED SINGLE DENSITY (SSSD) FLOPPY ON VS80;  
 -5 = DUAL SIDED DOUBLE DENSITY (DSDD) ON VS25/VS45, VS85/VS90/VS100/VS300.  
 -7 = MAGNETIC TAPE (Only available for PL/I and RPG conversion Packages)

NOTE: All orders for add-ons and upgrade equipment MUST include the work order numbers and serial numbers of the system components involved.



MODEL NUMBER	DESCRIPTION	INITIAL LICENSE FEE	MONTHLY LICENSE FEE	-----MONTHLY RENTAL PRICES-----			
				1 YEAR	2 YEAR	3 YEAR	5 YEAR

VS ALLIANCE SOFTWARE

Purchase customers must pay both the initial license fee and the annual license fee.

VS Alliance requires: VS45, 85, 90 or 100, minimum 1 Megabyte Main Memory, minimum 75MB Disk Drive for the Alliance software (It is recommended that this not be the system drive), 64K C Workstations, one (1) 64K Archiving Workstation, and 64K Printers. See Alliance upgrade section for upgrading printers to 64K. See VS upgrade charts for upgrading workstation to 64K. Alliance on a VS45 requires a 64K Archiving workstation that supports hard sector (2276C-1 or 2276C-3).

VS-ALLIANCE-5	VS-Alliance Base Level	\$ 11,000	\$ 84	\$ 605	\$ 561	\$ 484	440
VS-AL-VH-5	VS Alliance Visual Memory Autodial*	6,000	50	282	276	264	240
VS-AL-TIME-5	VS Alliance Time Management Calendar Directory Autodial* Messaging Voicegrams*	2,000	17	94	92	88	80
VS-AL-NOTES-5	VS Alliance Notebook	1,000	9	47	46	44	40
VS-AL-VOICE-5	AS Alliance Voice Documents* Dictation Transcription	2,000	17	94	92	88	80

\* Requires an Audio Workstation.

NOTE: VS-ALLIANCE BASE LEVEL SOFTWARE IS REQUIRED IN ORDER TO RUN ANY OF THE ALLIANCE PACKAGES.

UPGRADE JOB #	DESCRIPTION	PURCHASE PRICE	-----R E N T A L-----		
			SINGLE CHARGE	OR	MONTHLY 1 YEAR

The purchase/rental charges listed include any applicable difference in prices. For purchase systems the incremental maintenance charge is also due.

SOFTWARE UPGRADE

NOTE: The Annual Usage Fee is also due.

UJ-3163	Upgrade VS/IIS software to VS/ ALLIANCE BASE-LEVEL Software	ANNUAL LICENSE FEE			
		\$ 5,500	\$ 1,200	\$ 500	\$ 50

NOTE: All orders for add-ons and upgrade equipment MUST include the work order numbers and serial numbers of the system components involved.





MODEL NUMBER	DESCRIPTION	INITIAL LICENSE FEE	MONTHLY LICENSE FEE	-----MONTHLY RENTAL PRICES-----			
				1 YEAR	2 YEAR	3 YEAR	5 YEAR

**EDITOR PACKAGES**

VS-AL-WP-PLUS-5	Optional advance Word Processing package for VS-ALLIANCE Systems (Includes VS-ALLIANCE-5)	\$ 13,000	\$ 17	\$ 715	\$ 663	\$ 572	\$ 520
-----------------	---	-----------	-------	--------	--------	--------	--------

UPGRADE JOB #	DESCRIPTION	PURCHASE PRICE	-----R E N T A L-----	
			SINGLE OR MONTHLY CHARGE	MONTHLY 1 YEAR
UJ-3250-X	Advanced Word Processing package for VS-Alliance	2,000	400	40

MODEL NUMBER	DESCRIPTION	INITIAL LICENSE FEE	MONTHLY LICENSE FEE	-----MONTHLY RENTAL PRICES-----			
				1 YEAR	2 YEAR	3 YEAR	5 YEAR

VSX-1-X	VS EXPRESS Network, Messaging and Desk Top Management	\$ 6,000	\$ 50	\$ 330	\$ 306	\$ 264	\$ 240
---------	---	----------	-------	--------	--------	--------	--------

**GRAPHIC SOFTWARE**

VS GRAPHICS-X	VS Graphics Facility for VS-25/45/90/100 (Requires 6300 workstation to view graph)	\$ 3,000	\$ 30	\$ 153	\$ 138	\$ 132	\$ 120
VS/IIS-CHRTER-X	Business Graphics Menus for all Models of VS/IIS (Requires 64K workstation to run the menus or 6300 workstation to run menus and view the graph)	2,000	20	94	92	88	80

NOTE: X = ALL ORDERS MUST SPECIFY THE MEDIA TYPE BY THE APPROPRIATE MODEL NUMBER SUFFIX (I.E. -3 = SINGLE SIDED SINGLE DENSITY (SSSD) FLOPPY ON VS80;  
 -5 = DUAL SIDED DOUBLE DENSITY (DSDD) ON VS25/VS45, VS85/VS90/VS100/VS300.  
 -7 = MAGNETIC TAPE (Only available for P/1 and RPG conversion Packages)

NOTE: All orders for add-ons and upgrade equipment MUST include the work order numbers and serial numbers of the system components involved.

MODEL  
NUMBER

DESCRIPTION

INITIAL  
LICENSE  
FEE

MONTHLY  
LICENSE  
FEE

-----MONTHLY RENTAL PRICES-----  
1 YEAR 2 YEAR 3 YEAR 5 YEAR

The following discount schedule applies to the Wang Office:

WANG OFFICE SOFTWARE

QUANTITY ORDERED	DISCOUNT
1 - 2	0%
3 - 5	10%
6 - 10	20%
11 - 20	30%
OVER 20	40%

Discounts are allowed for quantity purchases (sales only; no rentals except as noted on exception basis). Orders must be submitted on a single purchase order, delivery may be to multiple delivery points, but must be within six (6) months of initial order. Quantity discounts are applied per model number not on an aggregate basis except as noted on an exception basis. Products for which Wang publishes multi-unit discounts shall receive the higher of the applicable published multi-unit quantity discount, or the Annual Volume Agreement discount, but not both.

VS OFFICE-1-X	WANG OFFICE for VS	\$ 6,000	\$ 50	\$ 330	\$ 306	\$ 264	\$ 240
OFM-1-X	Office File Manager Option (not for VS25)	5,000	42	275	255	220	200
VSOFFICE-2-X	WANG OFFICE for VS, IIS WP and Office File Manager	18,000	150	990	918	792	720
VSOFFICE-3-X	WANG OFFICE for VS, ALLIANCE BASE LEVEL, GRAPHICS, EZQUERY, and VS REPORT	30,000	250	1,650	1,530	1,320	1,200

UPGRADE JOB #	DESCRIPTION	PURCHASE PRICE	-----R E N T A L-----	
			SINGLE CHARGE	OR MONTHLY 1 YEAR

The purchase/rental charges listed include any applicable difference in prices. For purchase systems the incremental maintenance charge is also due.

UPGRADES

UJ-3224-X	VSEXRESS to VSOFFICE-1	N/A	N/A	N/A
UJ-3227-X	MAILWAY <sup>R</sup> LEVEL 3 to VSOF- FICE-1	N/A	N/A	N/A
UJ-3230-X	MAILWAY <sup>R</sup> POINT to VSOFFICE-1	\$ 4,000	\$ 800	\$ 80

NOTE: X = ALL ORDERS MUST SPECIFY THE MEDIA TYPE BY THE APPROPRIATE MODEL NUMBER SUFFIX  
(I.E. -3 = SINGLE SIDED SINGLE DENSITY (SSSD) FLOPPY ON VS80;  
-5 = DUAL SIDED DOUBLE DENSITY (DSDD) ON VS25/VS45, VS85/VS90/VS100/VS300.  
-7 = MAGNETIC TAPE (Only available for PL/1 and RPG conversion Packages)

NOTE: All orders for add-ons and upgrade equipment MUST include the work order numbers and serial numbers of the system components involved.



VS.

MODEL NUMBER	DESCRIPTION	INITIAL LICENSE FEE	MONTHLY LICENSE FEE	----- MONTHLY RENTAL PRICES -----			
				1 YEAR	2 YEAR	3 YEAR	5 YEAR
<u>APPLICATION SOFTWARE</u>							
NOTE: Monthly License Fees for HRMS software apply 12 months after the initial purchase.							
HRMS-02	Super Payroll (Customer Generated)	\$ 40,000	\$ 420	N/A	N/A	N/A	N/A
HRMS-04	Super Personnel	40,000	420	N/A	N/A	N/A	N/A
HRMS-05	Super Pension	37,000	420	N/A	N/A	N/A	N/A
HRMS-06	Super Payroll/Personnel (HRMS-02 & HRMS-04 Bundled)	72,000	840	N/A	N/A	N/A	N/A
<u>MATHPLANNER MODELING SYSTEM</u>							
MAPL-1-X	Wang Mathplanner (Single Unit) Modeling and Simulation Software Package	\$ 3,000	17	\$ 165	\$ 153	\$ 132	\$ 120

COMPANY CONFIDENTIAL  
 VS/3

NOTE: X = ALL ORDERS MUST SPECIFY THE MEDIA TYPE BY THE APPROPRIATE MODEL NUMBER SUFFIX (I.E. -3 = SINGLE SIDED SINGLE DENSITY (SSSD) FLOPPY ON VS80;  
 -5 = DUAL SIDED DOUBLE DENSITY (DSDD) ON VS25/VS45, VS85/VS90/VS100/VS300.  
 -7 = MAGNETIC TAPE (Only available for PL/I and RPG conversion Packages)

NOTE: All orders for add-ons and upgrade equipment MUST include the work order numbers and serial numbers of the system components involved.

MODEL NUMBER	DESCRIPTION	PURCHASE PRICE	MONTHLY MAINTENANCE	-----MONTHLY RENTAL PRICES-----			
				1 YEAR	2 YEAR	3 YEAR	5 YEAR

COMMUNICATIONS PROCESSORS AND OPTIONS

Specify required components individually, i.e., a front panel and connector must be ordered for each DLP board required for the external chassis.

VS-6554	External chassis for VS	\$ 2,500	\$ 50	\$ 138	\$ 128	\$ 110	100
---------	-------------------------	----------	-------	--------	--------	--------	-----

It is necessary that there be an available port for each DLP board installed in the chassis.

VS-TC	64K Communications Controller	2,000	25	110	102	88	80
VS-TC1	128K Communications Controller	2,500	30	138	128	110	100
VS-FP6554	Front panel/external chassis	200	N/A	N/A	N/A	N/A	N/A

Provides the front housing for the DLP board status light indicators and appropriate switches.

TCP-RS232	Connector for RS-232 or CCITT V.24 modem support for external chassis	200	N/A	N/A	N/A	N/A	N/A
TCP-RS366	Connector for RS366 or CCITT V.25 auto dial support for external chassis	200	N/A	N/A	N/A	N/A	N/A
TCP-X21	Connector for X.21 support for external chassis	200	N/A	N/A	N/A	N/A	N/A
2247V-4	4 Port Modem Sharing Unit Maximum cable length is 2000 feet/609 meters between 2247V-4 and any Remote Workstation using special cables. A 25'/7.6 meter cable is provided. See Cables section.	700	25	39	36	31	28

WORKSTATIONS

ALL WORKSTATIONS ARE UPPER/LOWER CASE 12 INCH (80 CHARACTER BY 24 LINES)

The maximum distance for serial device from the CPU is 2000 feet/609 meters. A 25 foot/7.6 meter cable is shipped with each serial peripheral device. Cables cannot be interconnected or spliced. Cable lengths must be submitted with the system/peripheral order.

WORKSTATION SWITCHES

SW16	Serial Device Switch capable of switching 32 serial devices between two VS systems (16 on each system)	\$ 3,500	\$ 20	\$ 179	\$ 161	\$ 154	140
------	--	----------	-------	--------	--------	--------	-----

NOTE: All orders for add-ons and upgrade equipment MUST include the work order numbers and serial numbers of the system components involved.



VS

MODEL NUMBER	DESCRIPTION	PURCHASE PRICE	MONTHLY MAINTENANCE	-----MONTHLY RENTAL PRICES-----			
				1 YEAR	2 YEAR	3 YEAR	5 YEAR

COMBINED WP/DP WORKSTATIONS

Combined Workstations are capable of alternately performing WP or DP functions. These workstations connect to an appropriate IDP for local use only via coaxial cable. Workstations with 64K memory are required for some IIS applications and for Remote WangNet operations to other systems.

2256C	Combined WP/DP 64K VS Workstation.	\$ 4,200	\$ 24	\$ 250	\$ 184	\$ 176	\$ 160
-------	------------------------------------	----------	-------	--------	--------	--------	--------

ARCHIVING WORKSTATIONS

Archiving Workstations with HS (Hard-sector) diskette controllers allow the use of WANG WP formatted diskettes. SS (Soft-sector) diskette controllers allow the use of Industry Compatible DP formatted diskettes (including 2200 MVP diskettes). The diskettes are 8 inches in diameter.

2276C-1	64K VS-AWS with Combined Keyboard, includes HS Controller. Stores up to 300K Bytes.	\$ 8,300	\$ 66	\$ 424	\$ 382	\$ 366	\$ 332
2276C-3	64K VS-AWS with Combined Keyboard, includes HS and SS Controller. Stores up to 1.2 megabytes.	9,300	68	475	428	410	372

ERGO 2 ARCHIVING WORKSTATIONS

2860-6	Ergonomic 64K Combined WP/DP VS-AWS, Includes HS Controller	\$ 8,600	\$ 66	\$ 473	\$ 439	\$ 405	\$ 370
2860-7	Ergonomic 64K Combined WP/DP VS-AWS, Includes HS and SS Controllers	9,600	68	528	490	452	413

4200 SERIES WORKSTATIONS

4200 Series Workstations consist of three components: a display monitor, an electronics unit, and a universal keyboard. Each model is upgradable within the series to a model of greater functionality or to a WANG Professional Computer.

Discounts are allowed for quantity purchases (sales only; no rentals except as noted on exception basis). Orders must be submitted on a single purchase order, delivery may be to multiple delivery points, but must be within six (6) months of initial order. Quantity discounts are applied per model number not on an aggregate basis except as noted on an exception basis\*. Products for which Wang publishes multi-unit discounts shall receive the higher of the applicable published multi-unit quantity discount, or the Annual Volume Agreement discount, but not both.

\* 4200 Series Workstations that are eligible for quantity discounts (model numbers 4205, 4210, 4220 and 4230) can also be aggregated to qualify for discounts. The 4250 has its own discount schedule and cannot be aggregated.

4205-VS	32K VS DP Workstation, CRT, Keyboard, Base						
	Quantities of 1 to 9 (-)	\$ 2,750	\$ 20	\$ 165	\$ 152	\$ 121	\$ 110
	Quantities of 10 to 29 (5%)	2,615	20	165	152	121	110
	Quantities of 30 to 49 (10%)	2,475	20	165	152	121	110
	Quantities of 50 and up (15%)	2,340	20	165	152	121	110

NOTE: All orders for add-ons and upgrade equipment MUST include the work order numbers and serial numbers of the system components involved.

MODEL NUMBER	DESCRIPTION	PURCHASE PRICE	MONTHLY MAINTENANCE	-----MONTHLY RENTAL PRICES-----			
				1 YEAR	2 YEAR	3 YEAR	5 YEAR

**4200 SERIES WORKSTATIONS (continued)**

4200 Series Workstations consist of three components: a display monitor, an electronics unit, and a universal keyboard. Each model is upgradable within the series to a model of greater functionality or to a WANG Professional Computer.

4210-VS	32K VS DP/MP/GPM Workstation, CRT, Keyboard, Base						
	Quantities of 1 to 9	\$ 3,400	\$ 20	\$ 204	\$ 187	\$ 150	136
	Quantities of 10 to 29	3,230	20	204	187	150	136
	Quantities of 30 to 49	3,060	20	204	187	150	136
	Quantities of 50 and up	2,890	20	204	187	150	136
4230-VS	64K VS DP/MP Workstation, CRT, Keyboard, Base						
	Quantities of 1 to 9	3,800	24	228	209	168	152
	Quantities of 10 to 29	3,610	24	228	209	168	152
	Quantities of 30 to 49	3,420	24	228	209	168	152
	Quantities of 50 and up	3,230					

Remote workstations include communications controllers allowing operation as a remote standalone workstation. A parallel printer may be attached directly to any Wang Remote workstation.

A 25 foot/7.6 meter modem cable is provided with each unit (please refer to cable section). Maximum distance from the modem is 50 feet/15.2 meters. If a 2247V-4 Modem Sharing Unit (MSU) is used then the maximum distance is 2000 feet/609 meters from the MSU.

4220-VS*	Remote VS Workstation, CRT, Keyboard, Base						
	Quantities of 1 to 9 (-)	2,500	18	150	138	110	100
	Quantities of 10 to 29 (5%)	2,375	18	150	138	110	100
	Quantities of 30 to 49 (10%)	2,250	18	150	138	110	100
	Quantities of 50 and up (15%)	2,125	18	150	138	110	100

\*Note: 4250 has unique discounts.

4250-VS	WPC VS Workstation						
	Quantities of 1 to 19 (-)	5,265	29	343	290	253	N/A
	Quantities of 20 to 49 (12%)	4,635	29	343	290	253	N/A
	Quantities of 50 to 149 (16%)	4,425	29	343	290	253	N/A
	Quantities of 150 to 249 (20%)	4,215	29	343	290	253	N/A

4200-AC001	4200 Series Monitor Arm Includes required 8 foot cable						
	Quantities of 1 to 9	225	N/A	14	13	10	9
	Quantities of 10 to 29	215	N/A	14	13	10	9
	Quantities of 30 to 49	205	N/A	14	13	10	9
	Quantities of 50 and up	195	N/A	14	13	10	9

4200-AC002	Desk Clamp (requires version 2 of the workstation base)						
	Quantities of 1 to 9	125	N/A	8	7	6	5
	Quantities of 10 to 29	120	N/A	8	7	6	5
	Quantities of 30 to 49	115	N/A	8	7	6	5
	Quantities of 50 and up	110	N/A	8	7	6	5

NOTE: All orders for add-ons and upgrade equipment MUST include the work order numbers and serial numbers of the system components involved.



VS

MODEL NUMBER	DESCRIPTION	PURCHASE PRICE	MONTHLY MAINTENANCE	-----MONTHLY RENTAL PRICES-----			
				1 YEAR	2 YEAR	3 YEAR	5 YEAR
<u>5300 ERGONOMIC WORKSTATIONS (ERGO 3)</u>							
Ergo 3 workstations have three components: order one display monitor, one electronics package and one keyboard to complete a proper configuration. Electronics packages may be configured with any Display Monitor. The 5300 Series workstations use the same language options as Ergo 2 terminals.							
5310	Green Display Audio (Alliance only)	\$ 1,150	\$ 20	\$ 72	\$ 51	\$ 49	44
5320	Green Display	1,050	20	66	46	44	40
5330	Black/White Audio (Alliance only)	1,250	20	77	56	53	48
5340	Black on White Display	1,150	20	72	51	49	44
<u>ELECTRONICS PACKAGE</u>							
5300/VS-IIS64	64K Combined Workstation Electronics for WP/DP application	\$ 3,050	\$ 15	\$ 198	\$ 134	\$ 128	116
5300H/VS	64K Combined Workstation Electronics for WP/DP application with WangNet Interface (Peripheral Band)	3,650	20	198	161	154	140
5300/VS-AL-AUD	64K Audio Combined 5300 Series Electronics Package (VS Alliance ONLY)	3,800	32	248	166	159	144
5300H/VS-AUD	64K Audio Combined 5300 Series Electronics Package (VS Alliance ONLY) with WangNet Interface (Peripheral Band)	4,400	37	240	194	185	168
<u>KEYBOARD</u>							
5300KBD/IIS-STD	Combined Keyboard for WP/DP application (For WangNet Ergos)	\$ 525	N/A	\$ 28	\$ 26	\$ 24	22
<u>OPTIONS</u>							
HEADSET	Headset for Audio Transcription (Audio only)	\$ 20	N/A	N/A	N/A	N/A	N/A
FOOTPEDAL	Footpedal for Audio Transcription (Audio only)	50	N/A	N/A	N/A	N/A	N/A
TELSET	Auxiliary Telephone Set (AUDID ONLY) Required for use in situations where the customer telephone instrument cannot be used. A TELSET MUST accompany all Int'l Audio Workstation orders.	100	N/A	N/A	N/A	N/A	N/A

NOTE: All orders for add-ons and upgrade equipment MUST include the work order numbers and serial numbers of the system components involved.



MODEL NUMBER	DESCRIPTION	PURCHASE PRICE	MONTHLY MAINTENANCE	-----MONTHLY RENTAL PRICES-----			
				1 YEAR	2 YEAR	3 YEAR	5 YEAR

6300 SERIES GRAPHIC WORKSTATIONS

6300 Series Workstations consist of three components. The Display Monitor includes the CRT only. The Electronics Package consists of all the workstation boards, power supply and packaging. The Keyboard includes a specific Wang Keyboard, all are standard with numeric keypad. The 6300 Graphics Workstation can be attached to an OIS, VS or VS/UIS system. The printer for Graphics is the 5577 high-density Matrix Printer.

DISPLAY MONITOR

6340	Black and White Graphic Display	\$ 1,350	\$ 20	\$ 90	\$ 63	\$ 60	\$ 54
------	---------------------------------	----------	-------	-------	-------	-------	-------

ELECTRONICS PACKAGE

6300/VS-64	VS Graphic Electronics for VS with 64K.	\$ 3,900	\$ 20	\$ 258	\$ 180	\$ 172	\$ 156
------------	---	----------	-------	--------	--------	--------	--------

KEYBOARD

UNI/KBD-US	United States Low Profile Serial Keyboard	\$ 525	N/A	\$ 32	\$ 30	\$ 26	\$ 24
------------	---	--------	-----	-------	-------	-------	-------

MASS STORAGE

DISK SWITCHES

SW04	Disk Switch Option for 2265V-1 for secondary access of disk resource (price is per disk).	\$ 4,500	\$ 25	\$ 230	\$ 207	\$ 198	\$ 180
SW04-1	Disk Switch Option on 2265V-2 for secondary access of disk resource (price is per disk).	4,500	25	230	207	198	180
SW04-3	Disk Switch Option for 2265V-3 for secondary access of disk resource (price is per disk)	4,500	25	230	207	198	180

DISK DRIVES

NOTE: The 2280V-3 has 15M bytes of removable disk storage, the remainder is fixed.

NO DISK CABLES ARE BUNDLED WITH THE DISKS. YOU MUST ORDER DISK CABLES AS SEPARATE LINE ITEMS.

2280V-3	90MB F/R Disk Drive	\$ 13,000	\$ 186	\$ 715	\$ 663	\$ 572	\$ 520
2265V-1	75MB Removable Disk Drive	12,000	160	660	612	528	480
2265V-2	288MB Removable Disk Drive.	18,000	255	990	918	792	720

NOTE: The disk drives listed above are available with the high altitude option. In altitudes above 5,000 feet this option MUST be ordered. When ordering these options, add an "HA" to the end of the model number and \$350 to the purchase price.

NOTE: All orders for add-ons and upgrade equipment MUST include the work order numbers and serial numbers of the system components involved.

VS/ 3 - 47

COMPANY CONFIDENTIAL  
REPLACES: 02/01/84  
EFFECTIVE: 05/01/84

VS

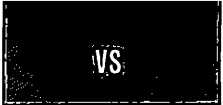

MODEL NUMBER	DESCRIPTION	PURCHASE PRICE	MONTHLY MAINTENANCE	MONTHLY RENTAL PRICES			
				1 YEAR	2 YEAR	3 YEAR	5 YEAR

**DISK DRIVES (continued)**

NO DISK CABLES ARE BUNDLED WITH THE DISKS. YOU MUST ORDER DISK CABLES AS SEPARATE LINE ITEMS.

2265V-3	640MB Fixed Disk Drive. Requires: 25V50-X For VS45 22V78-X For VS80 22V88-X For VS85/90/100	\$ 28,000	\$ 180	\$ 1,540	\$ 1,428	\$ 1,232	\$ 1,120
---------	---	-----------	--------	----------	----------	----------	----------

NOTE: DISK DRIVES LISTED BELOW AVAILABLE ON VS300 ONLY.

2375V-C1	364MB Fixed Disk Drive with Data Storage Cabinet.	28,000	134	1,540	1,428	1,232	1,120
2375V-1	364MB Fixed Add-On Disk Drive. (Requires 2375V-C1)	25,000	124	1,375	1,275	1,100	1,000
2267V-1	76MB Removable Add-On Disk Drive. (Requires 2375V-C1)	12,000	160	660	612	528	480

MAGNETIC TAPE DRIVES WITHOUT IQP'S

2529V	Four Track 6400 BPI 14 Megabyte, 30 inches-per-second Tape Cartridge	\$ 4,500	\$ 53	\$ 248	\$ 230	\$ 198	\$ 180
2209V	Magnetic Tape Drive (9-track, 1600 bpi, 75 ips, 120KB per second)	13,000	103	715	663	572	520
2209V-B	9-track, 1600 bpi Magnetic Tape Drive (75 ips, 120KB per second) Pre-requisite is a 2209V. Used for drive 2 through 4.	12,000	92	660	612	528	480
2209V-2	Dual Density Magnetic Tape Drive (9 track, 800/1600 bpi densities, 75 ips, 60/120KB per second)	14,000	114	770	714	616	560
2209V-2B	Magnetic Tape Drive. (9 track, 800/1600 bpi densities, 75 ips) Pre-requisite is a 2209V-2. Used for drive 2 through 4.	13,000	103	715	663	572	520

NOTE: All orders for add-ons and upgrade equipment MUST include the work order numbers and serial numbers of the system components involved.

COMPANY CONFIDENTIAL  
REPLACES: 02/01/84  
EFFECTIVE: 06/01/84

COMPANY CONFIDENTIAL  
 VS  
 COMPANY CONFIDENTIAL

MODEL NUMBER	DESCRIPTION	PURCHASE PRICE	MONTHLY MAINTENANCE	-----MONTHLY RENTAL PRICES-----			
				1 YEAR	2 YEAR	3 YEAR	5 YEAR
<b>6250 BPI MAGNETIC TAPE DRIVES WITHOUT TOP'S</b>							
2219V-1	Dual Density (1600/6250 bpi) Tape Subsystem consisting of tape transport mechanism and formatter	\$ 50,900	\$ 427	\$ 2,800	\$ 2,596	\$ 2,240	2,036
2219V-1B	Dual Density Add-on Drive (up to three can be attached to 2219V-1)	25,500	209	1,403	1,301	1,122	1,020
2219V-3	Tridensity Tape Subsystem (800/1600/6250 BPI) consisting of tape transport mechanism and formatter	56,000	444	3,080	2,856	2,464	2,240
2219V-3B	Tridensity Add-on Drive (up to three can be attached to 2219V-3)	31,000	227	1,705	1,581	1,364	1,240
<b>PRINTERS</b>							
<b>PARALLEL</b>							
Parallel Printers are available for attachment to Remote Workstation ONLY							
2233R	Bidirectional Remote Matrix Printer 100/120 CPS, 10/12.2 Pitch.	\$ 2,500	\$ 35	\$ 128	\$ 115	\$ 110	100
2235R	Bidirectional Remote Matrix Printer 181/222 CPS, 10/12.2 Pitch.	3,500	48	179	161	154	140
2273V-1	Remote W/S Low Speed Band Printer with 1 Utility B Print Band. See General Information Section of VS Price List for Print Band Alternatives.	9,500	103	485	437	418	380
2281WCR	30 CPS Remote Wide Carriage Parallel Daisy Printer.	6,000	44	306	276	264	240
2281WR	30 CPS Remote Parallel Daisy Printer.	4,500	44	230	207	198	180

NOTE: All orders for add-ons and upgrade equipment MUST include the work order numbers and serial numbers of the system components involved.

VS

MODEL NUMBER	DESCRIPTION	PURCHASE PRICE	MONTHLY MAINTENANCE PRINTERS (continued)	MONTHLY RENTAL PRICES-----			
				1 YEAR	2 YEAR	3 YEAR	5 YEAR
<b>SERIAL</b>							
The maximum distance for serial device from the CPU is 2000 feet/609 meters. A 25 foot/7.6 meter cable is shipped with each serial peripheral device. Cables cannot be interconnected or spliced. Cable lengths <u>must</u> be submitted with the system/peripheral order. Printers required for VS Alliance must be 64K Printers.							
5533	120 CPS Bidirectional Matrix Printer 12.2 Pitch ONLY, 158 Columns OIS ONLY	\$ 3,500	\$ 46	\$ 165	\$ 161	\$ 154	140
5535	180/222 CPS Bidirectional Matrix Printer, 10 Pitch ONLY, 132 Columns ONLY	4,500	64	212	207	198	180
5573	Low Speed Band Printer with 1 Utility B Print Band. See General Information section of VS Price List for Print Band Alternatives.	9,500	103	485	437	418	380
5574	Medium Speed Band Printer with 1 Utility C Print Band. See General Information Section of VS Price List for Print Band Alternatives.	13,250	145	623	610	583	530
5575	High Speed Band Printer with Powered Paper Stacker and 1 print band. See General Information section of VS Price List for print band alternatives.	29,500	330	1,505	1,357	1,298	1,180
5577V	192/40 CPS High Density Matrix Printer for Vs Systems only	5,975	55	281	275	263	239
DM/DS-55	55 CPS, Bidirectional Daisy Wheel Printer (OIS, Alliance)	5,000	43	295	255	220	200
6581W-1	35 CPS Daisy Wheel Printer	6,000	49	282	255	220	200
6581WC-1	35 CPS Wide Carriage Daisy Wheel Printer	7,000	49	329	322	308	280
DM/DS-20	20 CPS, Bidirectional Daisy Wheel Printer (OIS, Alliance)	2,695	37	127	124	119	108
LPS-12V	Laser Printer System - 12 For VS Systems Monthly per page charges after 5,000 pages 1.5 cents purchase 3.2 cents rental	20,000	275	920	820	760	N/A

NOTE: All orders for add-ons and upgrade equipment MUST include the work order numbers and serial numbers of the system components involved.

MODEL NUMBER	DESCRIPTION	PURCHASE PRICE	MONTHLY MAINTENANCE	-----MONTHLY RENTAL PRICES-----			
				1 YEAR	2 YEAR	3 YEAR	5 YEAR
<u>PRINTERS (continued)</u>							
<u>SERIAL (continued)</u>							
LIS-12V	Laser Imaging System For Wang VS Systems Monthly per page charges after 5,000 pages 1.5 cents purchase 3.2 cents rental.	\$ 26,000	\$ 300	\$ 1,196	\$ 1,066	988	N/A
<u>ALLIANCE</u>							
DW/DS-55	55 CPS, Bidirectional Daisy Wheel Printer (DIS, Alliance)	\$ 5,000	\$ 43	\$ 295	\$ 255	\$ 220	200
6581W-1	35 CPS Daisy Wheel Printer	6,000	49	282	255	220	200
6581WC-1	35 CPS Wide Carriage Daisy Wheel Printer	7,000	49	329	322	308	280
5533-1	120 CPS Bidirectional Matrix Printer. 12.2 Pitch ONLY, 158 Columns DIS ONLY	3,500	46	165	161	154	140
5535-1	180 CPS Bidirectional Matrix Printer. 10 Pitch ONLY, 132 Columns ONLY	4,500	64	212	207	198	180
5577A	192/40 CPS High Density Matrix Printer for Alliance Systems only	5,975	55	281	275	263	239
5581WD-1	Twinhead Daisy Wheel Printer	9,750	104	459	449	429	390
LPS-12A	Laser Printing System - 12 for Alliance 250 Systems Monthly per page charges after 5,000 pages 1.5 cents purchase, 3.2 cents rental	20,000	275	920	820	760	N/A
LIS-12A	Laser Imaging System for Wang Alliance 250 Systems Monthly per page charges after 5,000 pages 1.5 cents purchase, 3.2 cents rental	26,000	300	1,196	1,066	988	N/A
<u>PRINTERS OPTIONS</u>							
<u>FORMS TRACTORS</u>							
FT-1	Mono-Directional Forms Tractor For 5577	\$ 250	N/A	N/A	N/A	N/A	N/A

NOTE: All orders for add-ons and upgrade equipment MUST include the work order numbers and serial numbers of the system components involved.





MODEL NUMBER	DESCRIPTION	PURCHASE PRICE	MONTHLY MAINTENANCE	-----MONTHLY RENTAL PRICES-----				
				1 YEAR	2 YEAR	3 YEAR	5 YEAR	

PRINTERS OPTIONS (continued)  
FORMS TRACTORS (continued)

FT-2	Mono-Directional Forms Tractor for DM-20	\$ 250	N/A	N/A	N/A	N/A	N/A
BFT-1	Bidirectional Forms Tractor for 2281W, 5541W, 5577, 6581W and DM/22-20	300	N/A	N/A	N/A	N/A	N/A
BFT-2	Bidirectional Forms Tractor for 2281WC, 5541WC and 6581WC	300	N/A	N/A	N/A	N/A	N/A
BFT-55	Bidirectional forms tractor for DM/OS-55 printer	300	N/A	N/A	N/A	N/A	N/A

TWIN SHEET FEEDERS

The following Twin Sheet Feeders use paper sizes:  
8 1/2 " x 11 " to 8 1/2 " x 14 " or  
21.59 cm x 27.94 cm to 21.59 cm x 35.56 cm

TSF-31	Twin Sheet Feeder for 6581W	\$ 2,000	\$ 21	\$ 110	\$ 102	\$ 88	\$ 80
TSF-41	Twin Sheet Feeder for 6581WC	2,000	21	110	102	88	80
TSF-51	Twin Sheet Feeder for DM/OS-20 DM/22-20	2,000	21	110	102	88	80
TSF-61	Twin Sheet Feeder for 5577	2,000	21	110	102	88	80

The following Twin Sheet Feeders for Int'l use paper sizes:  
8 1/4 " x 11 3/4" to 8 1/4 " x 14 " or  
20.95 cm x 29.70 cm to 20.95 cm x 35.56 cm

TSF-33	Twin Sheet Feeder for 6581W	\$ 2,000	\$ 21	\$ 110	\$ 102	\$ 88	\$ 80
TSF-43	Twin Sheet Feeder for 6581WC	2,000	21	110	102	88	80
TSF-53	Twin Sheet Feeder for DM/OS-20 DM/22-20	2,000	21	110	102	88	80
TSF-63	Twin Sheet Feeder for 5577	2,000	21	110	102	88	80
DSF-55	Dual Sheet Feeder for DM/OS-55 8 1/2" X 11" paper size	2,000	21	110	102	88	80

NOTE: All orders for add-ons and upgrade equipment MUST include the work order numbers and serial numbers of the system components involved.

MODEL NUMBER	DESCRIPTION	PURCHASE PRICE	MONTHLY MAINTENANCE	-----MONTHLY RENTAL PRICES-----			
				1 YEAR	2 YEAR	3 YEAR	5 YEAR
<b>ENVELOPE FEEDERS</b>							
EF-1	Envelope Feeder for 6581W 115 VAC 60HZ (U.S. sized business envelopes; (#7 3/4, 9, 10)	\$ 2,000	\$ 33	\$ 110	\$ 102	\$ 88	\$ 80
EF-21	Envelope Feeder for DW-20 Printer. 115 VAC 60hz (U.S. sized business envelopes; #7 3/4, 9, 10)	2,000	33	110	102	88	80
EF-2	Envelope Feeder for 6581W 220 VAC 50hz (U.S. sized business envelopes; (#7 3/4, 9, 10)	2,000	33	110	102	88	80
EF-22	Envelope Feeder for DW-20 Printer. 220 VAC 50hz (U.S. sized business envelopes; #7 3/4, 9, 10)	2,000	33	110	102	88	80
EF-3	Envelope Feeder for 6581W 220 VAC 50z (Int. sized business envelopes; min. 98.4 x 190.5mm max. 108 x 222.4mm)	2,000	33	110	102	88	80
EF-23	Envelope Feeder for DW-20 Printer 220 VAC 50hz (Int'l sized business envelopes; min. 98.4 x 190.5 mm max. 108 x 222.4 mm)	2,000	33	110	102	88	80

NOTE: All orders for add-ons and upgrade equipment MUST include the work order numbers and serial numbers of the system components involved.

VS/ 3 - 53

COMPANY CONFIDENTIAL  
 REPLACES: 02/01/84  
 EFFECTIVE: 05/01/84



VS

PART NUMBER	CABLE LENGTH	DESCRIPTION	PRICE
-------------	--------------	-------------	-------

VS DISK CABLES

When configuring VS disk cables, two types of cables are required: "A" cables for data transfer and "B" cables for disk status. An "A" CPU to disk cable connects the first drive to the disk IOP while the "A" daisy chain cables link the first through fourth drives. "B" disk to CPU cables connect a drive to a port on the disk IOP. Both "A" and "B" cables are required for disk interfacing to the disk IOP. A dual ported disk drive must be "A" and "B" cabled to both CPU's. VS system and drive type must be considered when selecting the appropriate cables. Further information is provided in the configuration guide section of this manual.

VS 80 DISK CABLES"A" CABLES - CPU TO DISK

220-3041-6	15ft.	2280V-1,2,3	\$ 315
220-3041-14	25ft.	2280V-1,2,3	410
220-3041-15	50ft.	2280V-1,2,3	540
220-3041-3	15ft.	2265V-1	315
220-3041-10	25ft.	2265V-1	410
220-3041-11	50ft.	2265V-1	540
220-3041-4	15ft.	2265V-2A, 2A1	315
220-3041-12	25ft.	2265V-2A, 2A1	410
220-3041-13	50ft.	2265V-2A, 2A1	540
220-3041-26	15ft.	2265V-3	315
220-3041-27	25ft.	2265V-3	410
220-3041-28	50ft.	2265V-3	540

"B" CABLES - DISK TO CPU

220-3033-18	15ft.	2280V-1,2,3	315
220-3033-19	25ft.	2280V-1,2,3	410
220-3033-30	50ft.	2280V-1,2,3	540
220-3033-12	15ft.	2265V-1	315
220-3033-13	25ft.	2265V-1	410
220-3033-32	50ft.	2265V-1	540
220-3033-14	15ft.	2265V-2A, 2A1, 2B	315
220-3033-15	25ft.	2265V-2A, 2A1, 2B	410
220-3033-31	50ft.	2265V-2A, 2A1, 2B	540
220-3033-40	15ft.	2265V-3	315
220-3033-41	25ft.	2265V-3	410
220-3033-42	50ft.	2265V-3	540

"A" CABLES - DAISY CHAIN

220-3031-1	10ft.	2280V's	220
220-3031-2	10ft.	2265V-2's	220
220-3031-3	10ft.	2265V-1's	220
220-3031-4	10ft.	2265V-1 & 2265V-2's	220
220-3031-5	10ft.	2280V's & 2265V-2's	220
220-3031-6	10ft.	2265V-1 & 2280V's	220
220-3031-10	10ft.	2265V-3 to 2265V-1	220
220-3031-11	10ft.	2265V-3 to 2265V-2	220
220-3031-12	10ft.	2265V-3 to 2280V's	220
220-3031-13	10ft.	2265V-3 to 2265V-3	220

NOTE: All orders for add-ons and upgrade equipment MUST include the work order numbers and serial numbers of the system components involved.



PART NUMBER	CABLE LENGTH	DESCRIPTION	PRICE
<u>VS DISK CABLES (continued)</u>			
<u>VS 48/85/90/100 DISK CABLES</u>			
<u>"A" CABLES - CPU TO DISK</u>			
220-3309-07	15ft.	2280V-1, 2, 3	\$ 315
220-3309-20	25ft.	2280V-1, 2, 3	410
220-3309-21	50ft.	2280V-1, 2, 3	540
220-3041-9	15ft.	2265V-1	315
220-3041-16	25ft.	2265V-1	410
220-3041-17	50ft.	2265V-1	540
220-3041-8	15ft.	2265V-2A, 2A1	315
220-3041-18	25ft.	2265V-2A, 2A1	410
220-3041-19	50ft.	2265V-2A, 2A1	540
220-3041-23	15ft.	2265V-3	315
220-3041-24	25ft.	2265V-3	410
220-3041-25	50ft.	2265V-3	540
<u>"B" CABLES - DISK TO CPU</u>			
220-3308-21	15ft.	2280V-1, 2, 3	315
220-3308-22	25ft.	2280V-1, 2, 3	410
220-3308-33	50ft.	2280V-1, 2, 3	540
220-3033-25	15ft.	2265V-1	315
220-3033-26	25ft.	2265V-1	410
220-3033-35	50ft.	2265V-1	540
220-3033-23	15ft.	2265V-2A, 2A1, 2B	315
220-3033-24	25ft.	2265V-2A, 2A1, 2B	410
220-3033-34	50ft.	2265V-2A, 2A1, 2B	540
220-3033-37	15ft.	2265V-3	315
220-3033-38	25ft.	2265V-3	410
220-3033-39	50ft.	2265V-3	540
<u>"A" CABLES - DAISY CHAIN</u>			
220-3031-1	10ft.	2280V's	220
220-3031-2	10ft.	2265V-2's	220
220-3031-3	10ft.	2265V-1's	220
220-3031-4	10ft.	2265V-1 & 2265V-2's	220
220-3031-5	10ft.	2280V's & 2265V-2's	220
220-3031-6	10ft.	2265V-1 & 2280V's	220
220-3031-10	10ft.	2265V-3 to 2265V-1	220
220-3031-11	10ft.	2265V-3 to 2265V-2	220
220-3031-12	10ft.	2265V-3 to 2280V's	220
220-3031-13	10ft.	2265V-3 to 2265V-3	220

NOTE: All orders for add-ons and upgrade equipment MUST include the work order numbers and serial numbers of the system components involved.

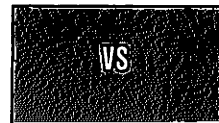

PART NUMBER	CABLE LENGTH	DESCRIPTION	PRICE
<u>VS300 DISK CABLES</u>			
<u>"A" CABLES - CPU TO DATA STORAGE CABINET</u>			
220-3041-29	15ft.	2375V-C1 Data Storage Cabinet Cable \$	315
220-3041-30	25ft.	2375V-C1 Data Storage Cabinet Cable	410
220-3041-31	50ft.	2375V-C1 Data Storage Cabinet Cable	540
<u>"B" CABLES - DATA STORAGE CABINET TO CPU</u>			
220-3033-43	15ft.	2375V-C1 Data Storage Cabinet Cable	315
220-3033-44	25ft.	2375V-C1 Data Storage Cabinet Cable	410
220-3033-45	50ft.	2375V-C1 Data Storage Cabinet Cable	540
<u>EXIT "A" CABLE</u>			
220-3390	6ft.	2375V-C1 Data Storage Cabinet Cable	220

VS UPGRADE GENERAL INFORMATION

1. The Sales Representative must submit the appropriate Upgrade Job Number whenever ordering upgrade equipment. There is a unique Upgrade Job number for each upgrade. Upgrading printers and workstations, if necessary, require separate, unique Upgrade Job numbers.
2. All Upgrade Job numbers have been listed in this pricing manual.
3. Equipment being considered for field conversion must be inspected by Customer Engineering to determine that its condition will permit such conversion. This inspection is a prerequisite to accepting a customer conversion order. All CPUs MUST BE INSPECTED BY CUSTOMER ENGINEERING PRIOR TO ENTERING A MEMORY UPGRADE ORDER.
4. A customer who has purchased hardware pays the amount listed under the column "Purchase Single Charge." This includes both the "upgrade" charge and the difference, if any, in the list price of the items. Maintenance on the upgraded unit is also due.
5. All prices include total charges within the standard service area of 50 miles from a service office. An additional one hour (service labor rate) travel charge per 25 miles will be added to all calls beyond the standard service area.
6. Trade in credit will be given on the 2260V 10 MB Disk Drive if the customer decides to purchase a large capacity disk drive. (Consult the Sales Policy Manual, trade-in equipment section.)
7. Submission of "upgrades" must be accompanied by the serial number of the pieces of serialized hardware affected (e.g., memory is being added to a workstation, the serial number of that workstation must be noted). Reference must be made to the purchase and work order numbers on which the equipment was originally ordered.
8. "Upgrade" charges apply to both purchased and rented equipment.
9. A customer with rented hardware must pay the "Rental Single Charge". The incremental difference in the monthly rental rates is also due. If the "upgrade" is to a CPU, a new minimum rental period, the same as the initial rental period, will commence upon CPU upgrade completion. If the "upgrade" is to a workstation, communications, printer, or other peripheral, its rental term will be made coterminous with the CPU.

NOTE: All orders for add-ons and upgrade equipment MUST include the work order numbers and serial numbers of the system components involved.

**QUANTITY DISCOUNTS FOR WORKSTATION UPGRADES**

Discounts are allowed for quantity purchases (sales only; no rentals except as noted on exception basis\*). Orders must be submitted on a single purchase order, delivery may be to multiple delivery points, but must be within six (6) months of initial order. Quantity discounts are applied per model number not on an aggregate basis except as noted on an exception basis. Products for which Wang publishes multi-unit discounts shall receive the higher of the applicable published multi-unit quantity discount, or the Annual Volume Agreement discount, but not both.

\* Quantity discounts for the General Workstation Upgrade Discount apply to both purchase and rental (Single Charge) prices. Discounts apply only to delivery at a single location, not to multiple delivery points.

QUANTITY ORDERED	DISCOUNT
1 - 19	0%
20 - 39	10%
40 +	15%

Computation of the discount for upgrades is calculated on either the full purchase price or the rental single charge. It does not affect the actual rental or maintenance due.

COMPANY CONFIDENTIAL  
WANG

NOTE: All orders for add-ons and upgrade equipment MUST include the work order numbers and serial numbers of the system components involved.

COMPANY CONFIDENTIAL  
REPLACES: 02/01/84  
EFFECTIVE: 05/01/84





UPGRADE JOB #	DESCRIPTION	PURCHASE PRICE	-----R E N T A L-----		
			SINGLE CHARGE	OR	MONTHLY 1 YEAR

The purchase/rental charges listed include any applicable difference in prices. For purchase systems the incremental maintenance charge is also due.

WORKSTATIONS

UJ-500	5526 to 2246C (Upgrade involves a trade-in of hardware)	\$ 4,750	\$ 100	\$ 10
UJ-501	5536-1 to 2246C	1,100	700	70
UJ-3039	2246S to 2246C	2,050	300	30
UJ-503	5536-2 to 2246C	550	500	50
UJ-3011	2246S to 2256C	2,700	300	30
UJ-3012	2246C to 2256C	1,150	450	45
UJ-3013	5536-4 to 2256C	725	650	65
UJ-3020	5536-1 to 2256C	1,700	650	65
UJ-3021	5536-2 to 2256C	1,375	650	65
UJ-3022	5536-3 to 2256C	1,050	650	65
UJ-3127	2246S to 2246S-1	550	200	20
UJ-3128	2246S to 2246S-2	550	200	20
UJ-3129	2246S to 2246S-3	550	200	20
UJ-3138	UPG. 2246S 2BD to 32K Memory (For 2BD Workstations)	825	450	45
UJ-3162	UPG 2246S 3BD to 32K Memory (For 3BD Workstation)	825	450	45
UJ-3242	4205-VS to 4210-VS	1,400	450	45
UJ-3251	4210-VS to 4230-VS	1,500	450	45
UJ-3252	4220-VS to 4230-VS	2,050	450	45
UJ-3253	4205-VS to 4230-VS	1,500	450	45

COMPANY CONFIDENTIAL  
 WANG

NOTE: All orders for add-ons and upgrade equipment MUST include the work order numbers and serial numbers of the system components involved.

UPGRADE JOB #	DESCRIPTION	PURCHASE PRICE	-----R E N T A L-----		
			SINGLE CHARGE	OR	MONTHLY 1 YEAR

The purchase/rental charges listed include any applicable difference in prices. For purchase systems the incremental maintenance charge is also due.

WORKSTATIONS (continued)

UJ-3254	4205-VS, 4210-VS, 4220-VS, or 4230-VS to Wang PC- includes: PC CPU w/5 slot chassis, Monochrome Monitor Card, Local Communications Option, 5 1/4" Diskette drive	\$ 4,425	\$ 500	\$ 50
UJ-3255	4220-VS to Wang PC- includes: PC CPU w/5 slot chassis, Monochrome Monitor Card, Remote Communications Option, 5 1/4" Diskette drive	3,425	500	50

ARCHIVING WORKSTATIONS

UJ-3038	2266S-3 to 2266C-3	\$ 275	\$ 250	\$ 25
UJ-3096	2266S-2 to 2266C-3	1,450	300	30
UJ-3095	2266S-1 to 2266C-3	1,450	300	30
UJ-3041	2266C-1 to 2266C-3 2266S-1 to 2266S-3 2276C-1 to 2276C-3	1,450	300	30
UJ-3042	2266S-2 to 2266S-3	1,450	300	30
UJ-3094	2266S-1 to 2266C-1	275	250	25
UJ-3135	2266C-1 to 2276C-1	825	N/A	N/A
UJ-3136	2266C-1 to 2276C-3	1,750	N/A	N/A
UJ-3137	2266C-3 to 2276C-3	825	N/A	N/A

TOP'S

UJ-504	22V06-1 to 22V06-2	\$ 1,050	\$ 150	\$ 15
UJ-505	22V06-1 to 22V06-3	1,925	150	15
UJ-506	22V06-2 to 22V06-3	1,050	150	15
UJ-507	22V07-1 to 22V07-2	725	150	15

NOTE: All orders for add-ons and upgrade equipment MUST include the work order numbers and serial numbers of the system components involved.

VS/ 3 - 59

COMPANY CONFIDENTIAL  
REPLACES: 02/01/84  
EFFECTIVE: 05/01/84

VS



UPGRADE JOB #	DESCRIPTION	PURCHASE PRICE	-----R E N T A L-----	
			SINGLE OR CHARGE	MONTHLY 1 YEAR

The purchase/rental charges listed include any applicable difference in prices. For purchase systems the incremental maintenance charge is also due.

IDP'S (continued)

UJ-3043	22V07-1 to 22V17-1	\$ 150	\$ 150	\$ 15
UJ-3044	22V07-1 to 22V17-2	725	150	15
UJ-3045	22V07-2 to 22V17-2	175	150	15
UJ-3067	22V17-1 to 22V17-2	650	150	15
UJ-3062	22V27-1 to 22V27-2	725	150	15
UJ-3104	22V26-1 to 22V26-2	950	150	15
UJ-3105	22V26-1 to 22V26-3	1,750	150	15
UJ-3106	22V26-2 to 22V26-3	950	150	15

TAPE DRIVES  
AND CPU'S

UJ-508	2209V to 2209V-2	\$ 2,150	\$ 1,150	\$ 115
UJ-524	2209A to 2209V	250	160	15

VS DISK DRIVES

UJ-3156	2280V-2 to 2280V-3	\$ 2,400	\$ 1,400	\$ 140
UJ-3157	2280V-1 to 2280V-3	3,400	1,400	140

2200 OR DIS TO VS UPGRADES

These disk upgrades permit 2200 (2280N-X) and DIS (6580-X) disk drives (26.8, 53.6 and 80.4MB) to be upgraded to VS45/80/90/100 (30, 60, 90, 75MB) disk drives and DIS (6565 275MB) to a VS 288MB disk drive. The VS disks must be configured with the appropriate disk IDP's.

VS-80

UJ-3103	6565 to 2265V-2	\$ 3,000	\$ 3,000	\$ 300
UJ-3153	2280N-3 to 2280V-3, (2200 to VS-80)			
	6580-3 to 2280V-3 (DIS to VS-80)	250	250	25

NOTE: All orders for add-ons and upgrade equipment MUST include the work order numbers and serial numbers of the system components involved.

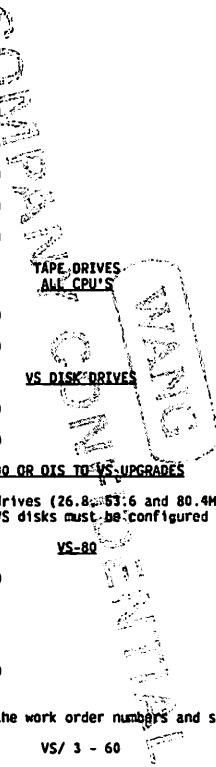

UPGRADE JOB #	DESCRIPTION	PURCHASE PRICE	-----R E N T A L-----		
			SINGLE CHARGE	OR	MONTHLY 1 YEAR

The purchase/rental charges listed include any applicable difference in prices. For purchase systems the incremental maintenance charge is also due.

VS45/85/90/100

UJ-3110	6565 to 2265V-2	\$ 3,000	\$ 3,000	\$ 300
UJ-3154	2280N-3 to 2280V-3, (2200 to VS-45/90/100)			
	2280V-3 to 2280V-3, (VS-80 to VS-45/90/100)			
	6580-3 to 2280V-3, (OIS to VS-45/90/100)	250	250	25

NOTE: MUST be of like capabilities (e.g. 2280N-3 to 2280V-3)

PRINTERS

UJ-509	2221W to 2221V	\$ 550	\$ 150	\$ 15
UJ-510	2231W-2 to 2231V-2	150	150	15
UJ-3049	2273-1/2273V-1 to 5573	2,200	2,000	200
UJ-3050	2273-2 to 5574	2,200	2,000	200

NOTE: UJ-2158 CURRENT CUSTOMERS (INSTALLED OR BOOKED) AS OF OCTOBER 4, 1983 UNTIL JANUARY 31, 1984 WILL BE CHARGED \$4,300 FOR UPGRADE. NEW CUSTOMERS AFTER OCTOBER 4, 1983 UNTIL JUNE 1, 1984 WILL BE CHARGED \$6,000 FOR UPGRADE.

UJ-2158	LPS-12 to LIS-12 (For OIS 100, Alliance, and VS Systems)	7,750	2,000	200
---------	--	-------	-------	-----

TCP UPGRADES

UJ-3088	6554-1 to 6554-2	\$ 2,375	\$ 150	\$ 15
UJ-3089	6554-1 to 6554-3	4,675	250	25
UJ-3090	6554-1 to 6554-4	6,975	325	32
UJ-3091	6554-2 to 6554-3	2,375	150	15
UJ-3092	6554-2 to 6654-4	4,675	250	25
UJ-3093	6554-3 to 6554-4	2,575	325	32

NOTE: All orders for add-ons and upgrade equipment MUST include the work order numbers and serial numbers of the system components involved.



VS

UPGRADE JOB #	DESCRIPTION	PURCHASE PRICE	-----R E N T A L-----	
			SINGLE CHARGE	OR MONTHLY 1 YEAR

The purchase/rental charges listed include any applicable difference in prices. For purchase systems the incremental maintenance charge is also due.

ENVELOPE & TWIN SHEET FEEDER UPGRADES

UJ-1071	Envelope Feeder upgrade for 6581W	\$ 250	N/A	N/A
UJ-1096	Twin Sheet Feeder upgrade for 6581W (Electronics only)	500	N/A	N/A
UJ-1195	Twin Sheet Feeder	250	N/A	N/A
UJ-1196	TSF & EF Upgrade for all DW-20	275	N/A	N/A
UJ-1226	Paper Tensioner for FT-1	125	100	10
UJ-1257	Dual Sheet Feeder Upgrade for 6581W	500	N/A	N/A

NOTE: All orders for add-ons and upgrade equipment MUST include the work order numbers and serial numbers of the system components involved.



TRADE-IN POLICY

Below is an adaptation of the current trade-in policy indicating the allowances:

Wang Laboratories, Inc. will accept certain Wang-manufactured items for trade-in credit when accompanied by a customer order for the purchase of new equipment as specified below. The trade-in allowance provides for the following percentage of credit on the equipment being traded in which can be applied to the current list price of the new equipment being purchased.

1. ALLOWANCE FROM BASE PURCHASE PRICE OF OLD EQUIPMENT				
IN THE	BETWEEN FIRST	BETWEEN SECOND	BEYOND THREE	
FIRST YEAR	AND SECOND YEAR	AND THIRD YEAR	YEARS	
40%	30%	20%		\$ 60/item

- Trade-in credit cannot exceed 50% of the purchase price of the new equipment ordered.
- The trade-in schedule covers serialized equipment, including options, memory, and upgrades which are an integral part of the system.
- Trade-in credit applies only to equipment purchased from Wang Laboratories, Inc. or a duly authorized agent. The order must be accompanied by a copy of the original purchase order or other proof of ownership of the equipment to be traded in.
- Age of equipment is determined by the date the new order is received at Wang from the date of the original shipment of the traded-in equipment.
- Trade-in credit does not apply to the following items:

Cables.  
Furniture.  
Supplies.  
Software.  
Demonstration equipment.  
Inoperative damaged items.  
Equipment that has been modified by unauthorized persons.  
Stolen equipment.  
Rental equipment.  
Refurbished equipment.

NOTE: All orders for add-ons and upgrade equipment MUST include the work order numbers and serial numbers of the system components involved.

VS.

GENERAL INFORMATION

**PRINT BANDS FOR 2273-1, 2273-2, 2273V-1, 5573 and 5574:**

Customer may select additional bands or another band in lieu of the utility band based on the desired character set. Each additional band is available only on a purchase basis. For each different character sets a Factory installed PROM is required and should be ordered with the printer. The price is \$80 each. SEE SUPPLIES CATALOG for pricing and specifications for selection of additional bands and PROMS. Unless otherwise specified, a utility B Band will be shipped with the printer. Refer to the Wang Supplies Catalog for a full listing of bands and proms.

**PRINT BANDS FOR 5575:**

Customer may select additional bands or another band in lieu of the utility B band based on the desired character set. Additional character set PROMS are not required. SEE SUPPLIES CATALOG for pricing and specifications for selection of additional/alternated bands. Unless otherwise specified, a 64 character Utility B band will be shipped with the printer. Refer to the Wang supplies catalog for a full listing of bands.

**OPERATING SYSTEM SOFTWARE**

Wang software is designed to operate at maximum efficiency with a minimum of overhead. The operating system and the host central processor are inseparable and will not function properly if not used together in an unmodified state. Therefore, customer modification to the operating system are not allowed. Wang supported utilities, compilers, sorts, data management modules, telecommunications protocols, word processing programs and other licensed programs should not be modified.

Should program changes be made contrary to this policy, the customer should be notified in writing that Wang Laboratories will be unable to maintain the installed system, or to apply program fixes until said software is returned to its unmodified state or until an unmodified, new release is installed. Customer Engineering service performed to diagnose, localize, and repair modified software is not included in the Wang maintenance contract and will be billed separately.

The Multiple Systems License is available for PURCHASE ONLY.

The Multiple System License (195-yyyy-MSL) is available to all customers that have purchased or rented at least one copy of a specific software product at the full Initial License Fee price (195-yyyy-3 or -5 or -7). The customer must supply the work order number (s) and CPU serial number (s) on which the software product was booked at the Full License Fee Price. By purchasing this option the customer is entitled to make and install ONE additional copy of the specified software PER MULTIPLE SYSTEMS LICENSE purchased. Wang DOES NOT supply the customer with the media or additional copies of the software. The customer is responsible for copying the software at the central site, distributing and installing the software at the secondary locations (s).

Wang Standard Software Support (195-yyyy-STD) is available to all customers purchasing applicable software. This coverage affords the customer the following services for a basic fee:

- Telephone support.
- On-site support for product problem determination,
- automatic customer updates.

Wang Central Site Support (195-yyyy-CSS) is available for customers secondary sites that have at least one site with Wang Standard Software Support (195-yyyy-STD). The customer MUST reference the work order number (s) and CPU serial number (s) on which this support plan has been ordered to be eligible for this coverage. Wang Central Site Support services listed below:

- Telephone support.
- On-site support for product problem determination and automatic customer updates at the CENTRAL SITE that is covered by the Wang
- Standard Software Support agreement.

**NOTE:** All orders for add-ons and upgrade equipment MUST include the work order numbers and serial numbers of the system components involved.

**VS25**

The VS25 and VS45 are the most recent additions to Wang's family of information processing systems. They are based on newly implemented system architecture, and are especially suited to the office environment. The VS25 is an entry-level system that accommodates up to 10 workstations, and houses either 1 or 2 fixed 34 MB disks or 1 fixed 76MB disk within its compact cabinet. Extensive data communications and network access are supported by up to 4 data communications controllers. The Remote Diagnostic feature (under user security control) enhances Wang's ability to diagnose system problems and make timely repairs. The VS25 can be ordered with 512K, 768K, or 1024K bytes of main memory, and is field upgradable to a VS45.

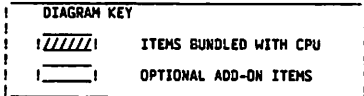
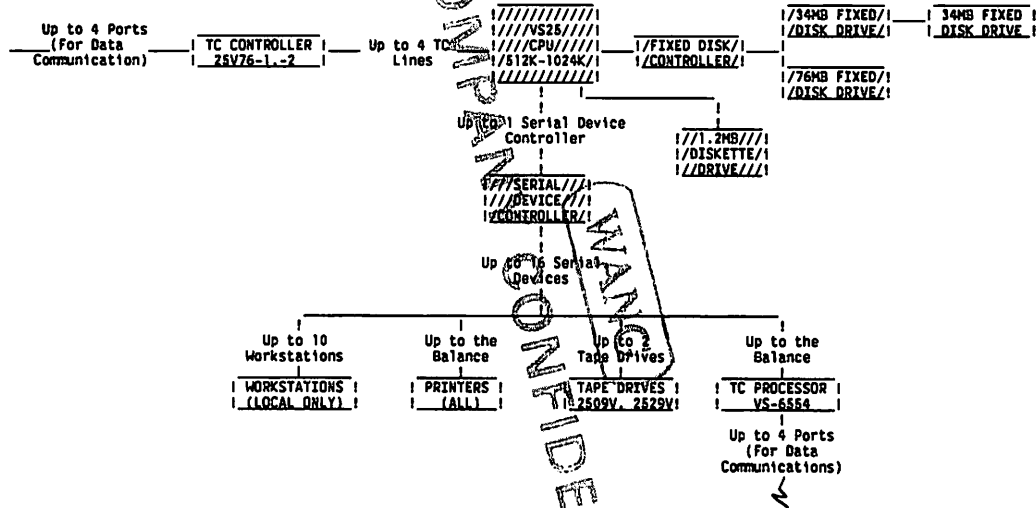

NOTE: All orders for add-ons and upgrade equipment MUST include the work order numbers and serial numbers of the system components involved.

COMPANY CONFIDENTIAL  
 REPLACES: 02/01/84  
 EFFECTIVE: 05/01/84





VS45

Wang's VS45 offers extended capabilities over the VS25 for those users who require more memory, workstations, and on-line storage. The VS45 can be configured with up to 1 Mb of main memory, 32 serial devices (20 workstations, maximum), and over 2.5 billion bytes of on-line disk storage. A fixed disk controller that supports one or two 34 MB fixed disks, one 76MB fixed disk, and/or an external disk drive controller that supports up to 4 external disk drives is available. In addition, up to 4 communications controllers permit extensive communications and networking. The Remote Diagnostic feature helps to facilitate troubleshooting and to diagnose system problems. Main memory for the VS45 can be ordered in several increments, from 512K to a maximum of 1024K bytes.

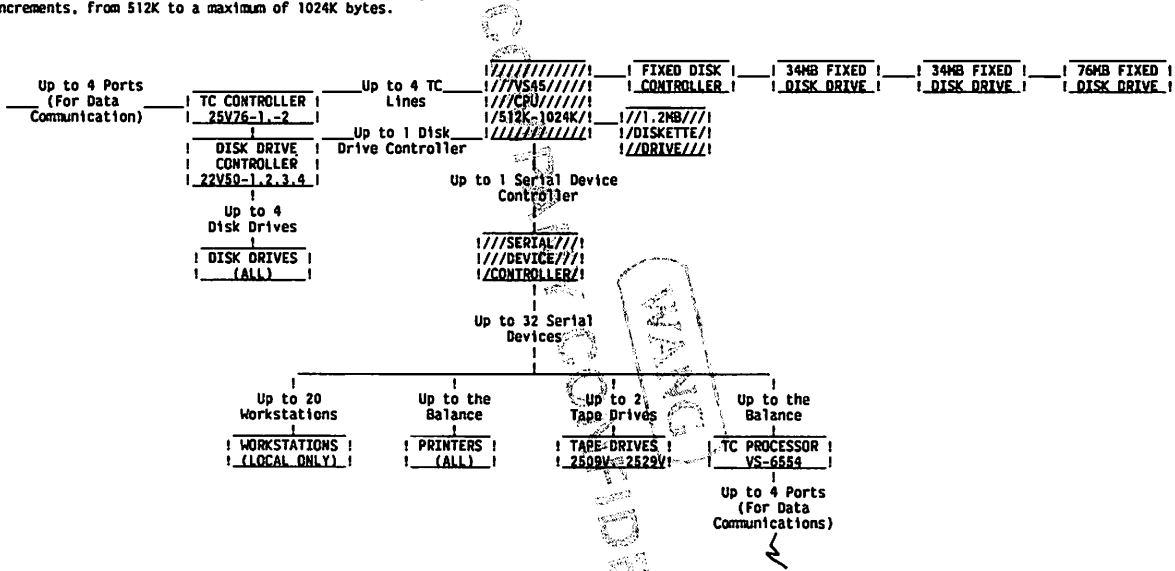

DIAGRAM KEY

▨ ITEMS BUNDLED WITH CPU

▭ OPTIONAL ADD-ON ITEMS

NOTE: All orders for add-ons and upgrade equipment MUST include the work order numbers and serial numbers of the system components involved.

VS80

The VS80 with appropriate Input/Output Processors (IOPs) supports up to 8 disk drives, providing over 5.0 billion bytes of on-line storage. In addition, up to 32 serial devices can be physically attached. VS80 main memory is available in 256K, 384K, or 512K byte increments.

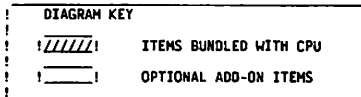
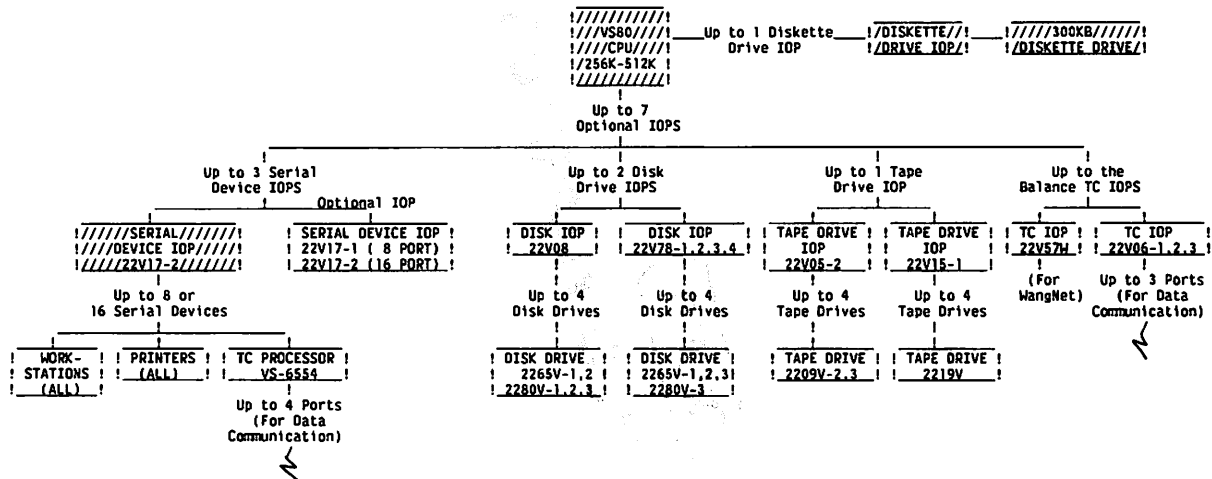

NOTE: All orders for add-ons and upgrade equipment MUST include the work order numbers and serial numbers of the system components involved.



**VS85**

The VS85 is the entry level member of the 32-bit family of VS Systems. Main memory on a basic model is 1 MB, expandable to 4 MB in 1 MB increments and an optional 32 KB of cache memory. Up to 6 Input/Output Processors (IOPs) are supported by the VS85. The VS85 with cache is field upgradable to a VS100. For systems without the cache option, the VS85 supports over 1.2 billion bytes on-line disk storage and up to 32 workstations. For system with the cache option, the VS85 supports over 2.4 billion bytes of on-line disk storage and up to 64 workstations.

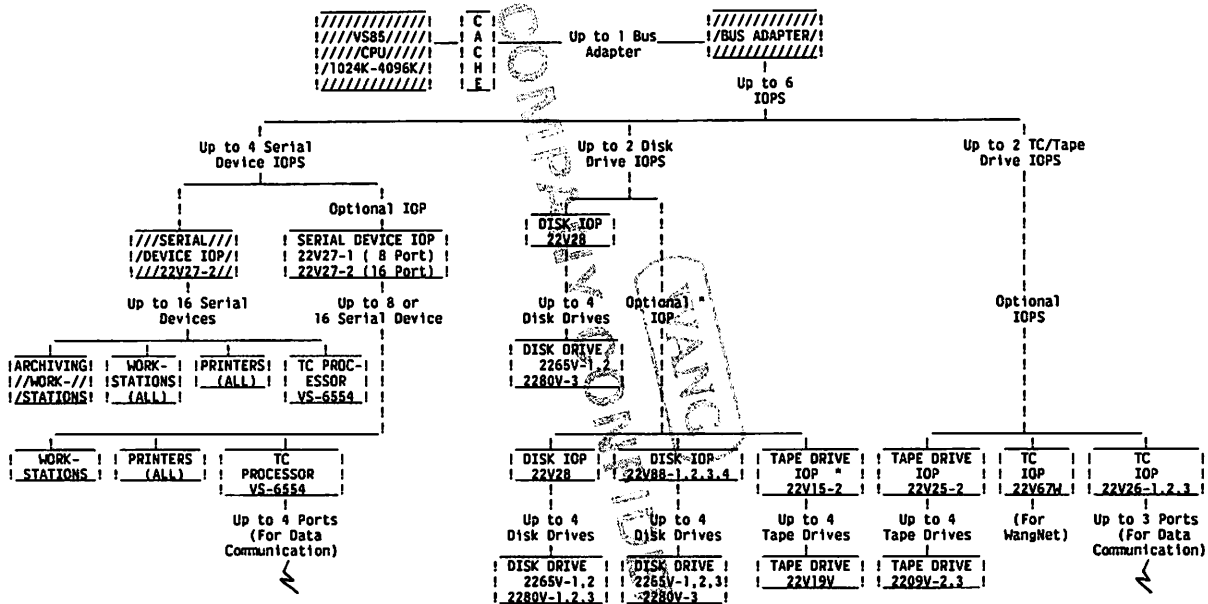

\*VS85 with cache option may have an optional second disk IOP or a 22V15-2 Tape IOP

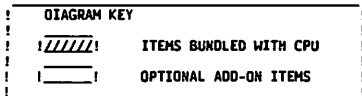

NOTE: All orders for add-ons and upgrade equipment MUST include the work order numbers and serial numbers of the system components involved.

**VS90**

The VS90, stands between the VS85 and VS100 in terms of price and upgradability. Up to 8 Input/Output Processors (IOPs) and over 5 billion bytes of on-line storage are supported by the VS90. Up to 48 workstations are supported by the VS90. Main memory on a basic model is 1 MB, expandable to 4 MB in 1 MB increments. Because of similar architecture, the VS90 is easily upgradable to a VS100.

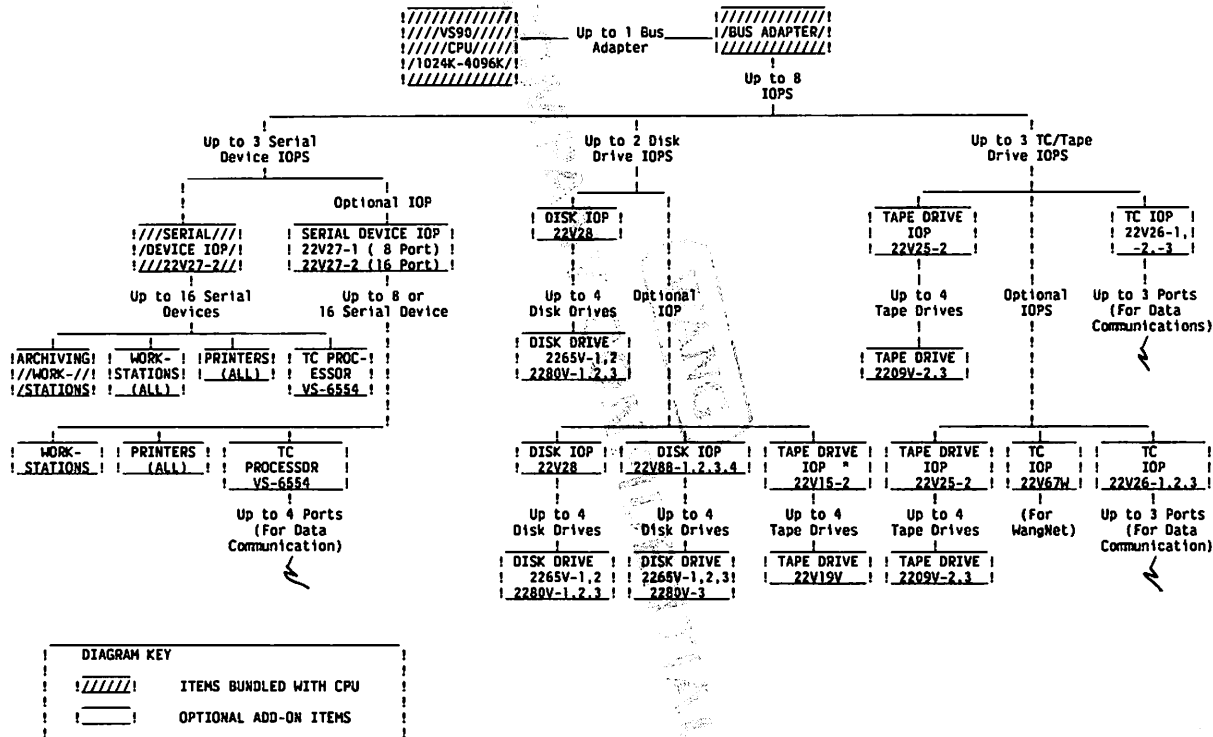

NOTE: All orders for add-ons and upgrade equipment MUST include the work order numbers and serial numbers of the system components involved.



## VS100

The VS100 is Wang's most powerful 32-bit processor. VS100 architecture includes main memory (1.0 MB to 8.0 MB), cache memory, and 2 bus adapters (1 standard, 1 optional) that interface with up to 16 Input/Output Processors. Up to 128 workstations are supported, and over 10 billion bytes of on-line storage can be configured.

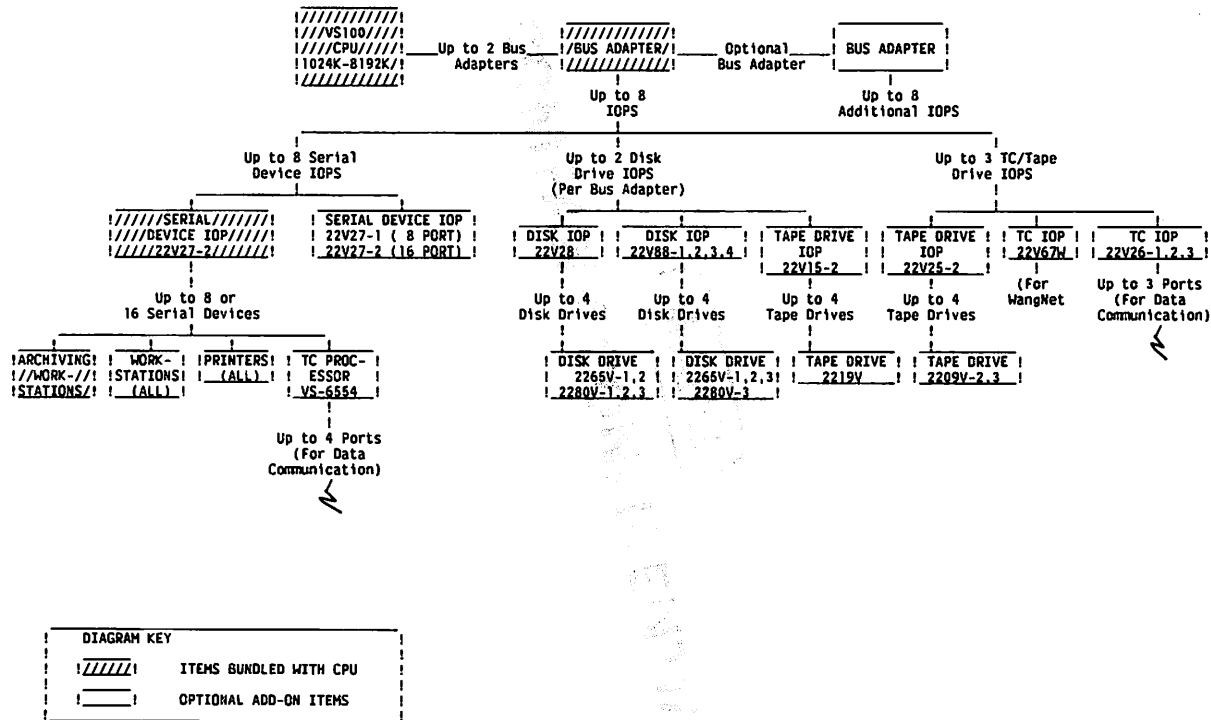

NOTE: All orders for add-ons and upgrade equipment MUST include the work order numbers and serial numbers of the system components involved.



**VS300**

The VS300 is Wang's newest and most powerful 32-Bit processor. The VS300 architecture includes main memory (4MB to 16MB), 32KB of Cache memory, support for up to 15 Input Output Controllers (one 32 port serial IOC is standard), and a Support Control Unit providing a system console, remote diagnostics and remote administration. The VS300 can support up to 192 workstations, and over 20.4 billion bytes of on line storage. Optionally, the VS300 can be equipped with a hardware floating point unit and battery backup.

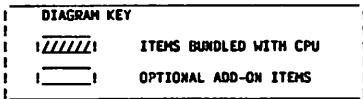
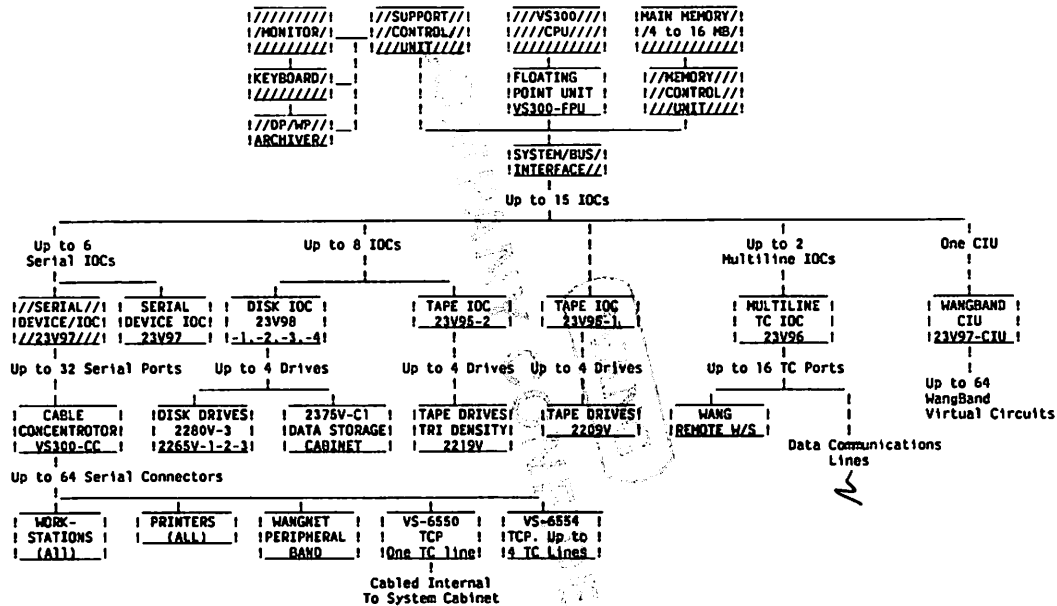

**NOTE:** All orders for add-ons and upgrade equipment **MUST** include the work order numbers and serial numbers of the system components involved.



## VS DISK CABLES

When configuring VS disk cables, two types of cables are required: "A" cables for data transfer and "B" cables for disk status. An "A" CPU to disk cable connects the first drive to the disk IOP while the "A" daisy chain cables link the first through fourth drives. "B" disk to CPU cables connect a drive to a port on the disk IOP. Both "A" and "B" cable types are required for disk interfacing to the disk IOP. A dual ported disk drive must be "A" and "B" cabled to both CPU's. VS system and drive type must be considered when selecting the appropriate cables. Examples of disk cabling are provided below.

## EXAMPLE 1: DISK CABLING FOR SINGLE SYSTEM

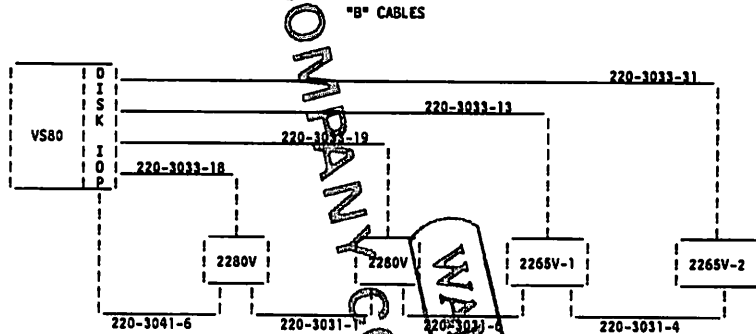

IN THIS EXAMPLE, THE CABLES THAT WOULD BE ORDERED ARE:

220-3041-6	VS80 "A" CABLE	15'
220-3033-18	VS80 "B" CABLE	15'
220-3033-19	VS80 "B" CABLE	25'
220-3033-13	VS80 "B" CABLE	25'
220-3033-11	VS80 "B" CABLE	50'
220-3031-1	"A" DAISY CHAIN	10'
220-3031-6	"A" DAISY CHAIN	10'
220-3031-4	"A" DAISY CHAIN	10'

NOTE: All orders for add-ons and upgrade equipment MUST include the work order number and serial numbers of the system components involved.

VS DISK CABLES

EXAMPLE 2: DISK CABLING FOR DUAL PORT OPTION

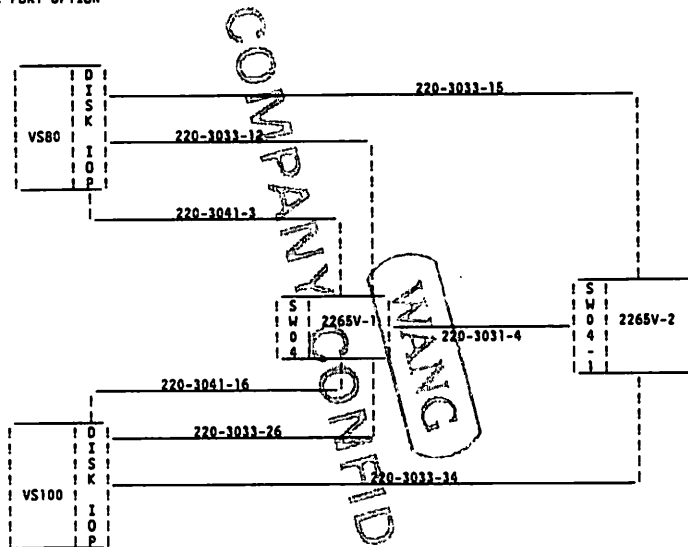

IN THIS EXAMPLE, THE CABLES THAT WOULD BE ORDERED ARE:

220-3041-3	VS80 "A" CABLE	15'
220-3041-16	VS100 "A" CABLE	25'
220-3033-12	VS80 "B" CABLE	15'
220-3033-15	VS80 "B" CABLE	25'
220-3033-26	VS100 "B" CABLE	25'
220-3033-34	VS100 "B" CABLE	50'
220-3031-4	"A" DAISY CHAIN	10'

NOTE: All orders for add-ons and upgrade equipment MUST include the work order numbers and serial numbers of the system components involved.



DISK CABLE CONFIGURATIONS

The following examples provide the necessary guidelines to configure disk cables for the new Data Storage Cabinet.

EXAMPLE 1: Daisy Chain from VS300 CPU to Data Storage Cabinet to a freestanding VS Disk Drive.

"B" CABLES

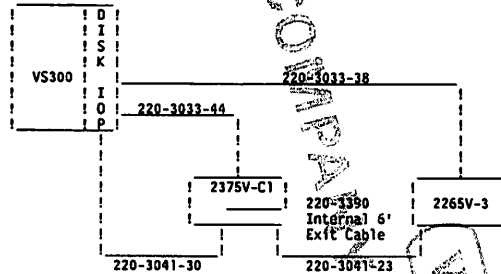

If the Data Storage Cabinet is to contain more than one drive the customer must order a 220-3033-44 "B" Cable for each additional internal drive. The additional drives are shipped with an internal "A" Daisy Cable.

IN THIS EXAMPLE, THE CABLES THAT WOULD BE ORDERED ARE:

220-3033-38	VS100 "B" CABLE	25'
220-3033-44	VS300 "B" CABLE	25'
220-3041-30	VS300 "A" CABLE	25'
220-3390	VS300 EXIT "A" CABLE	6'
220-3041-23	VS100 "A" CABLE	15'

NOTE: All orders for add-ons and upgrade equipment MUST include the work order numbers and serial numbers of the system components involved.

**EXAMPLE 2:** Daisy Chain from VS300 CPU to a freestanding VS Disk Drive to Data Storage Cabinet.

"B" CABLES

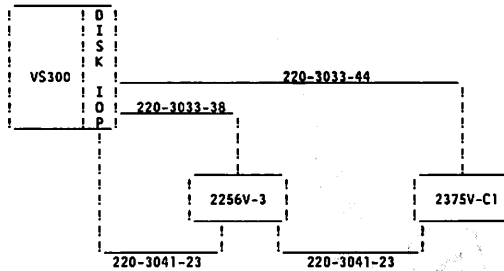

"A" CABLES

If the Data Storage Cabinet is to contain more than one drive the customer must order a 220-3033-44 "B" Cable for each additional internal drive. The additional drives are shipped with an internal "A" Daisy Cable.

IN THIS EXAMPLE, THE CABLES THAT WOULD BE ORDERED ARE:

220-3033-44	VS300 "B" CABLE	25'
220-3033-38	VS100 "B" CABLE	25'
220-3041-23	VS100 "A" CABLE	15'
220-3041-23	VS100 "A" CABLE	15'

NOTE: All orders for add-ons and upgrade equipment MUST include the work order numbers and serial numbers of the system components involved.



**EXAMPLE 3:** Daisy Chain from VS300 CPU to Data Storage Cabinet to a second Data Storage Cabinet.

"B" CABLES

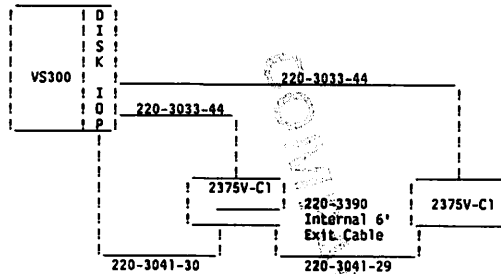

"A" CABLES

If the Data Storage Cabinet is to contain more than one drive the customer must order a 220-3033-44 "B" Cable for each additional internal drive. The additional drives are shipped with an internal "A" Daisy Cable.

IN THIS EXAMPLE, THE CABLES THAT WOULD BE ORDERED ARE:

220-3033-44	VS300 "B" CABLE	25'
220-3033-44	VS300 "B" CABLE	25'
220-3041-30	VS300 "A" CABLE	25'
220-3390	VS300 EXIT "A" CABLE	6'
220-3041-29	VS100 "A" CABLE	15'

NOTE: All orders for add-ons and upgrade equipment MUST include the work order numbers and serial numbers of the system components involved.

VS SYSTEMS  
ENTITLED SUPPORT SERVICES SUMMARY

Check Here if Acquired	SUPPORT DESCRIPTION	Activity Codes	Support Hours Up to-	Site Loc. Wang/Cust
—	<u>VS 25/45</u>			
*	Pre-Installation Meeting	<u>EP01</u>	<u>4 hrs.</u>	<u>X or X</u>
	Shared Access System Time	<u>EP03</u>	<u>8 hrs.**</u>	<u>X</u>
	Installation & Initial Testing	<u>ET 01</u>	<u>4 hrs.</u>	<u>X</u>
	Technical Consultation	<u>EC01</u>	<u>4 hrs.</u>	<u>X</u>
—	<u>VS 80</u>			
*	Pre-Installation Meeting	<u>EP01</u>	<u>4 hrs.</u>	<u>X or X</u>
*	Conversion Consultation	<u>EP02</u>	<u>16 hrs.</u>	<u>X or X</u>
	Shared Access System Time	<u>EP03</u>	<u>32 hrs.**</u>	<u>X</u>
	Installation & Initial Testing	<u>ET 01</u>	<u>4 hrs.</u>	<u>X</u>
	Technical Consultation	<u>EC01</u>	<u>4 hrs.</u>	<u>X</u>
—	<u>VS 85/90/100</u>			
	Pre-Installation Meeting	<u>EP01</u>	<u>8 hrs.</u>	<u>X or X *</u>
	Conversion Consultation	<u>EP02</u>	<u>24 hrs.</u>	<u>X or X *</u>
	Shared Access System Time	<u>EP03</u>	<u>64 hrs.**</u>	<u>X</u>
	Installation & Initial Testing	<u>ET 01</u>	<u>8 hrs.</u>	<u>X</u>
	Technical Consultation	<u>EC01</u>	<u>8 hrs.</u>	<u>X</u>

ENTITLED SUPPORT SERVICES DOCUMENTATION: Wang will provide one complete set of user reference and/or training documentation per system.

The support service specified here is Entitled Support to be delivered within 90 days of installation in accordance with Wang Policy and is provided at no additional charge with the equipment procurement. If support services not specified here are requested, the service may be provided in accordance with Wang Policies and at Wang's per call rates and terms then in effect.

\* Location of pre-install meeting and conversion consultation will be determined by Wang in order to best utilize Wang and customer resources.

\*\* These hours are machine time hours on Wang equipment (not Support time for consultation). Shared access system time is to be used for developmental purposes only on an as available basis.

NOTE: All orders for add-ons and upgrade equipment MUST include the work order numbers and serial numbers of the system components involved.

VS

VS UPGRADES/EXCHANGES  
ENTITLED SUPPORT SERVICES SUMMARY

Check Here if Acquired	<u>SUPPORT DESCRIPTION</u>	Activity <u>Codes</u>	Support Hours <u>Up to</u>	Site Loc. <u>Wang/Cust</u>
—	<u>VS 25/45 to VS 80</u>			
	Installation & Initial Testing	<u>EI 01</u>	<u>4 hrs.</u>	— <u>X</u>
	Technical Consultation	<u>EC01</u>	<u>2 hrs.</u>	— <u>X</u>
—	<u>VS 25/45 to VS 85/90/100</u>			
	Installation & Initial Testing	<u>EI 01</u>	<u>8 hrs.</u>	— <u>X</u>
	Technical Consultation	<u>EC01</u>	<u>4 hrs.</u>	— <u>X</u>
—	<u>VS 50/80 to VS 85/90/100</u>			
	Installation & Initial Testing	<u>EI 01</u>	<u>8 hrs.</u>	— <u>X</u>
	Technical Consultation	<u>EC01</u>	<u>4 hrs.</u>	— <u>X</u>

WANG  
 COMPANY CONFIDENTIAL

ENTITLED SUPPORT SERVICES DOCUMENTATION: Wang will provide one complete set of user reference and/or training documentation per system.

The support service specified here is Entitled Support to be delivered within 90 days of installation in accordance with Wang Policy and is provided at no additional charge with the equipment procurement. If support services not specified here are requested, the service may be provided in accordance with Wang Policies and at Wang's per call rates and terms then in effect.

NOTE: All orders for add-ons and upgrade equipment MUST include the work order numbers and serial numbers of the system components involved.

VS



SOFTWARE  
ENTITLED SUPPORT SERVICES SUMMARY

<u>SUPPORT DESCRIPTION</u>	<u>Activity Codes</u>	<u>Support Hours Up to</u>	<u>Site Loc. Wang/Cust</u>	<u>Class Training Up to</u>	<u># of Class Attendees at No Charge</u>
ATMS/WPS Pre-Installation Meeting	EP01	2 hrs.	X		
Technical Consultation	EC01	6 hrs.	X		
2200/WP Technical Consultation	EC01	4 hrs.	X		
VISUAL MEMORY Class Training	ET06		X	8 Hours	2 Operators
Technical Consultation	EC01	6 hrs.	X		
Pre-Installation Meeting	EP01	6 hrs.	X		
TIME MANAGEMENT Class Training	ET07		X	4 Hours	2 Operators
Technical Consultation	EC01	3 hrs.	X		
VOICE DOCUMENT Class Training	ET08		X	4 Hours	2 Operators
Technical Consultation	EC01	3 hrs.	X		
VS/WP Pre-Installation Meeting	EP01	2 hrs.	X		
Basic Word Processing Training	ET01		X	16 Hours	2 Operators*
Mathpak Training	ET05		X	4 Hours	1 Operator
Glossary Training	ET09		X	4 Hours	1 Operator
Technical Consultation	EC01	2 hrs.	X		
VS ALLIANCE Pre-Installation Meeting	EP01	12 hrs.	X		
Pre-Installation Consultation	ET01	4 hrs.	X		
Technical Consultation	EC01	8 hrs.	X		
Pre-Installation Seminar	ET02	3 hrs.	X		
Basic Word Processing Training	ET01		X	16 Hours	2 Operators
System Administration Course	ET01			40 Hours	2 Contacts
Glossary Training	ET09		X	4 Hours	1 Operator
Mathpak Training	ET05		X	4 Hours	1 Operator
VS EXPRESS Pre-Installation Meeting	EP01	2 hrs.	X		
Installation Consultation	ET01	2 hrs.	X		

ENTITLEMENT DOCUMENTATION: For each of the above software products purchased by the customer, Wang will provide one complete set of user reference and/or training documentation per system.

The support service specified here is Entitled Support to be delivered within 90 days of installation in accordance with Wang Policy and is provided at no additional charge with the software procurement. If support services not specified here are requested, the service may be provided in accordance with Wang Policies and at Wang's per call rates and terms then in effect.

\* The customer is entitled to Basic Word Processing training for one operator for every ten workstations procured with the initial system order.

NOTE: All orders for add-ons and upgrade equipment MUST include the work order numbers and serial numbers of the system components involved.

REMOTE WANGNET  
ENTITLED SUPPORT SERVICES SUMMARY

<u>SUPPORT DESCRIPTION</u>	<u>Activity Codes</u>	<u>Hours Up to-</u>	<u>Support Site Loc. Wang/Cust</u>
<b>Pre-Installation:</b>			
- Network Planning and Management Consultation Primary and Secondary Sites (Jointly)	<u>EP01</u>	<u>4 hrs.</u>	<u>— X</u>
<b>Installation:</b>			
- Installation and Checkout (Primary Site)	<u>EI 01</u>	<u>2 hrs.*</u>	<u>— X</u>
- Installation and Checkout (Secondary Site) ___ sites X 2 hours =	<u>EI 02</u>	<u>hrs.**</u>	<u>— X</u>
<b>Post-Installation:</b>			
- Network Management Consultation (Primary Site)	<u>EC 01</u>	<u>2 hrs.</u>	<u>— X</u>

**Other Deliverables:**

- One set of pre-installation materials
- One set of software and user reference documentation per system

**WANG**  
**COMPANY CONFIDENTIAL**

The support service specified above is Entitled Support in accordance with Wang Policy and is provided at no additional charge with the equipment procurement. If support services not specified here are requested, the service may be provided in accordance with Wang Policies and at Wang's per call rates and terms then in effect.

\* One (1) hour of testing (at the primary site) for each secondary site.

\*\* The two (2) hours per secondary site pertains to the Remote Wangnet software, regardless of which Wang system it is running on.

NOTE: All orders for add-ons and upgrade equipment MUST include the work order numbers and serial numbers of the system components involved.

TELECOMMUNICATIONS PROTOCOLS  
ENTITLED SUPPORT SERVICES SUMMARY

<u>SUPPORT DESCRIPTION</u>	<u>Activity Codes</u>	<u>Support Hours Up to</u>	<u>Site Loc. Wang/Cust</u>
<u>Technical Consultation</u>			
--for Emulator Products	<u>EC01</u>	<u>4 hrs.</u>	<u>___ X</u>
--for Networking Products	<u>EC01</u>	<u>6 hrs.</u>	<u>___ X</u>

STANDARD NETWORKING PRODUCTS\*

ASYNCHRONOUS PROTOCOLS

Teletype Emulation (TTY/TTE)  
2741  
2741  
RCH (2200)  
BURROUGHS TC 500/700

BISYNCHRONOUS PROTOCOLS

2780/3780/WPS, VSCOPY  
HASP (IBM 360/20)  
U 100/200 (UNIVAC)  
UT 200 (CDC)  
2200-2200

STANDARD NETWORKING PRODUCTS\*

3270 Bisynch products  
3270 SMA/SDLC products  
3777 SMA/SDLC  
X.21 (Packet Switching)  
X.25 (Packet Switching)  
Teletex

WANG

COMPANY CONFIDENTIAL

\*Note: All telecommunications products, as they relate to the Professional Computer, are supported under the generic "Professional Computer Support Policy". No Entitled Support hours are provided.

ENTITLED SUPPORT SERVICES DOCUMENTATION: Wang will provide one complete set of user reference documentation for user reference for each product.

The support service specified here is Entitled Support to be delivered within 90 days of installation in accordance with Wang Policy and is provided at no additional charge with the equipment procurement. If support services not specified here are requested, the service may be provided in accordance with Wang Policies and at Wang's per call rates and terms then in effect.

NOTE: All orders for add-ons and upgrade equipment MUST include the work order numbers and serial numbers of the system components involved.



Charter Business Graphics  
ENTITLED SUPPORT SERVICES SUMMARY

<u>SUPPORT DESCRIPTION</u>	<u>Activity Codes</u>	<u>Support Hours Up to-</u>	<u>Site Loc. Wang/Cust</u>	<u>Class Training Up to-</u>	<u># of Class Attendees at No Charge</u>
<u>Installation</u>					
— Seminar	<u>ETQ1</u>	<u>2 hrs.</u>	<u>X X*</u>	—	<u>1 Contact</u>

VS

WANG

COMPANY CONFIDENTIAL

\* Based on availability of hardware

ENTITLED SUPPORT SERVICES DOCUMENTATION: Wang will provide one complete set of user reference documentation per system.

The support service specified here is Entitled Support to be delivered within 90 days of installation in accordance with Wang Policy and is provided at no additional charge with the equipment procurement. If support services not specified here are requested, the service may be provided in accordance with Wang Policies and at Wang's per call rates and terms then in effect.

NOTE: All orders for add-ons and upgrade equipment MUST include the work order numbers and serial numbers of the system components involved.

VS Graphics Facility  
ENTITLED SUPPORT SERVICES SUMMARY

<u>SUPPORT DESCRIPTION</u>	<u>Activity Codes</u>	<u>Support Hours Up to-</u>	<u>Site Loc. Wang/Cust</u>	<u>Class Training Up to-</u>	<u># of Class Attendees at No Charge</u>
<u>Installation</u>					
_____ Seminar	<u>F101</u>	<u>2 hrs.</u>	<u>X X</u>	_____	<u>1 Contact</u>



ENTITLED SUPPORT SERVICES DOCUMENTATION: Wang will provide one complete set of user reference documentation per system.

The support service specified here is Entitled Support to be delivered within 90 days of installation in accordance with Wang Policy and is provided at no additional charge with the equipment procurement. If support services not specified here are requested, the service may be provided in accordance with Wang Policies and at Wang's per call rates and terms then in effect.

NOTE: All orders for add-ons and upgrade equipment MUST include the work order numbers and serial numbers of the system components involved.

WANG

COMPANY CONFIDENTIAL

COMPANY CONFIDENTIAL

Effective Date: MAY 1, 1984

- Prices and equipment availability subject to change without notice-

WANG OFFICE PRODUCT LINE PRICE LIST

TABLE OF CONTENTS

<u>DESCRIPTION</u>	<u>PAGE</u>	<u>EFFECTIVE DATE</u>
WANG OFFICE		
- Software	2	05/01/84
- Upgrades	2	05/01/84
- Packages	3	05/01/84
- Packages Upgrade	3	05/01/84

WANG  
COMPANY CONFIDENTIAL

WANG OFFICE

**INSTALLATION CHARGE**

There is no installation charge for initial installation of system(s). For add-on equipment or upgrade that are not designated customer-installable there is an installation charge of 3% of the purchase price - minimum charge \$100 per order.

**NOTE:** All orders for add-ons and upgrade equipment **MUST** include the work order numbers and serial numbers of the system components involved.

WANG

COMPANY CONFIDENTIAL



MODEL  
NUMBER

DESCRIPTION

INITIAL  
LICENSE  
FEE

MONTHLY  
LICENSE  
FEE

----- MONTHLY RENTAL PRICES -----  
1 YEAR 2 YEAR 3 YEAR 5 YEAR

The following discount schedule applies to the Wang Office:

WANG OFFICE SOFTWARE

		Quantity Ordered	Discount					
		1 - 5		0%				
		6 - 10		10%				
		11 - 20		20%				
		OVER 20		30%				
				40%				
VSOFFICE-1-X	WANG OFFICE for VS	\$ 6,000	\$ 50	\$	330	\$ 306	\$ 264	\$ 240
DFM-1-X	Office File Manager Option (not for VS25)	5,000	42		275	255	220	200
VSOFFICE-2-X	Wang Office for VS, IIS WP and Office File Manager (not for VS25)	18,000	150		990	918	792	720
VSOFFICE-3-X	WANG OFFICE for VS, ALLIANCE BASE LEVEL, GRAPHICS, EZQUERY and VS REPORT (not for VS25 or VS80)	30,000	250		1,650	1,530	1,320	1,200
OIS-OFFICE	Wang Office on the OIS	1,000			55	51	44	40
OIS-OFFICE-9	Wang Office on the OIS 40/50	1,000			55	51	44	40
AL-OFFICE	Wang Office on the Alliance	1,000			55	51	44	40
PC-AS009	PC OFFICE							
	Quantities 1 to 19	495	N/A		N/A	N/A	N/A	N/A
	Quantities 20 to 49	440	N/A		N/A	N/A	N/A	N/A
	Quantities 50 to 149	420	N/A		N/A	N/A	N/A	N/A
	Quantities 150 to 249	400	N/A		N/A	N/A	N/A	N/A

UPGRADE  
JOB #

DESCRIPTION

PURCHASE  
PRICE

----- R E N T A L -----  
SINGLE OR MONTHLY  
CHARGE 1 YEAR

The purchase/rental charges listed include any applicable difference in prices. For purchase systems the incremental maintenance charge is also due.

UPGRADES

UJ-3224-X	VSEXRESS to VSOFFICE-1	N/C			N/C	N/C		
UJ-3227-X	MAILWAY <sup>®</sup> LEVEL 3 to VSOFFICE-1	N/C			N/C	N/C		
UJ-3230-X	MAILWAY <sup>®</sup> POINT to VSOFFICE-1	\$ 4,000		\$	800	\$ 80		

NOTE: X = ALL ORDERS MUST SPECIFY THE MEDIA TYPE BY THE APPROPRIATE MODEL NUMBER SUFFIX  
(I.E. -3 = SINGLE SIDED SINGLE DENSITY (SSSD) FLOPPY ON VS80;  
-5 = DUAL SIDED DOUBLE DENSITY (DSDD) ON VS25/VS45, VS85/VS90/VS100/VS300.

NOTE: All orders for add-ons and upgrade equipment MUST include the work order numbers and serial numbers of the system components involved.

WO/ 4 - 2

COMPANY CONFIDENTIAL  
REPLACES: 02/01/84  
EFFECTIVE: 05/01/84



# WANG OFFICE

MODEL NUMBER	DESCRIPTION	PURCHASE PRICE	MONTHLY MAINTENANCE	-----MONTHLY RENTAL PRICES-----			
				1 YEAR	2 YEAR	3 YEAR	5 YEAR

### WANG OFFICE PACKAGES

OFFICECONTROL45	WANG OFFICE SYSTEM which includes 1MB of Main Memory, a diskette drive, 75MB of fixed/removable disk storage, a workstation and 2 communications ports. Software includes WANG OFFICE for VS and Office File Manager.	\$ 65,000	\$ 481	\$ 3,575	\$ 3,315	\$ 2,860	\$ 2,600
OFFICECONTROL85	WANG OFFICE SYSTEM which includes 1MB of Main Memory, a diskette drive, (2) 75MB of removable disk storage, a workstation and 2 communications ports. Software includes WANG OFFICE for VS and Office File Manager.	95,000	755	5,225	4,845	4,180	3,800

UPGRADE JOB #	DESCRIPTION	PURCHASE PRICE	-----R E N T A L-----		
			SINGLE CHARGE	OR	MONTHLY 1 YEAR

The purchase/rental charges listed include any applicable difference in prices. For purchase systems the incremental maintenance charge is also due

UJ-3239-X	Operation System and Program Development Utilities. Upgrade for OFFICECONTROL45 to VS-45 or OFFICECONTROL85 to VS-85	\$ 20,000	\$ 4,000	\$ 400
-----------	--	-----------	----------	--------

COMPANY CONFIDENTIAL

WANG

NOTE: X = ALL ORDERS MUST SPECIFY THE MEDIA TYPE BY THE APPROPRIATE MODEL NUMBER SUFFIX (I.E. -3 = SINGLE SIDED SINGLE DENSITY (SSSD) FLOPPY ON VS80; -5 = DUAL SIDED DOUBLE DENSITY (OSDD) ON VS25/VS45, VS85/VS90/VS100/VS300.

NOTE: All orders for add-ons and upgrade equipment MUST include the work order numbers and serial numbers of the system components involved.

COMPANY CONFIDENTIAL

Effective Date: MAY 1, 1984

- Prices and equipment availability subject to change without notice-

MAILWAY<sup>®</sup> PRODUCT LINE PRICE LIST

TABLE OF CONTENTS

<u>DESCRIPTION</u>	<u>PAGE</u>	<u>EFFECTIVE DATE</u>
LEVEL 1		
- Software	1	05/01/84
LEVEL 2		
- Software	2	05/01/84
- Upgrades	3	05/01/84
LEVEL 3		
- Software	4	05/01/84
ENTITLEMENT SUMMARY	5	05/01/84

THE MAILWAY<sup>®</sup> SYSTEM IS AVAILABLE IN U.S. LANGUAGE ONLY  
NO OTHER LANGUAGES ARE AVAILABLE AT THIS TIME

WANG  
COMPANY CONFIDENTIAL



**INSTALLATION CHARGE**

There is no installation charge for initial installation of system(s). For add-on equipment or upgrade that are not designated customer-installable there is an installation charge of 3% of the purchase price - minimum charge \$100 per order.

NOTE: All orders for add-ons and upgrade equipment MUST include the work order numbers and serial numbers of the system components involved.

WANG

COMPANY CONFIDENTIAL

MODEL NUMBER	DESCRIPTION	INITIAL LICENSE FEE	MONTHLY LICENSE FEE	-----MONTHLY RENTAL PRICES-----			
				1 YEAR	2 YEAR	3 YEAR	5 YEAR
<u>MAILWAY<sup>®</sup> LEVEL 1</u>							
MOIS-1	Level 1 Distribution Point software for DIS systems. (195-2123-3)	\$ 200	N/A	N/A	N/A	N/A	N/A
MWPS-1	Level 1 Distribution Point software for WPS Systems 20, 25, 30 (195-2124-3)	200	N/A	N/A	N/A	N/A	N/A
MSYS-1	Level 1 Distribution Point software for System 5 (195-2125-3)	200	N/A	N/A	N/A	N/A	N/A

**NOTE:** FOR MAILWAY<sup>®</sup> Level 1  
 Communications protocol requires a communications workstation in each WPS/DIS system, and a communications controller in each System 5. See appropriate WP/DIS price list.

<u>MAILWAY<sup>®</sup> LEVEL 2</u>							
MDC-2	Level 2 MAILWAY <sup>®</sup> Distribution Center Software. Requires MOIS-2, MWPS-2 or MSYS-2 at each office system. Requires MDC 50. (195-2133-4)	\$ 9,000	\$ 130	\$ 459	\$ 414	\$ 396	\$ 360
MPWPI-2	Level 2 Word Processing Interface, (MDC50). (195-2135-4)	9,345	64	477	430	412	374
MOIS-2	Level 2 Distribution Point Glossaries for DIS systems. (195-2136-3)	400	N/A	N/A	N/A	N/A	N/A
OIS-50 MOIS-2	OIS-50 MOIS-2 Level 2 Distribution Point Glossaries (195-2136-9)	400	N/A	N/A	N/A	N/A	N/A
MPOIS-2	Level 2 Distribution Point software for OIS Systems. (195-2141-3)	600	N/A	N/A	N/A	N/A	N/A
OIS-50 MPOIS-2	OIS-50 MPOIS-2 Level 2 Distribution Point Software (195-2139-9)	600	N/A	N/A	N/A	N/A	N/A
MPWPS-2	Level 2 Distribution Point software for WP systems 20, 25, 30. (195-2137-3)	400	N/A	N/A	N/A	N/A	N/A
MPSYS-2	Level 2 Distribution Point software for System 5. (195-2138-3)	200	N/A	N/A	N/A	N/A	N/A

**NOTE:** All orders for add-ons and upgrade equipment MUST include the work order numbers and serial numbers of the system components involved.





MODEL NUMBER	DESCRIPTION	PURCHASE PRICE	MONTHLY MAINTENANCE	-----MONTHLY RENTAL PRICES-----			
				1 YEAR	2 YEAR	3 YEAR	5 YEAR
MDC50	MAILWAY <sup>®</sup> Distribution Controller	\$ 56,100	\$ 722	\$ 2,862	\$ 2,581	\$ 2,469	\$ 2,244

NOTE: MAILWAY<sup>®</sup> Level 2 requires a communications controller on a WP System 5 and a system based communications controller on other WP and DIS systems. See appropriate WP/DIS Price List.

MDC50 - Mailway<sup>®</sup> Distribution Center System includes 256KB Memory, Diskette Drive, 60MB Fixed/Removable Disk Drive, Workstation, Printer, and 3 Communications ports. Five more combined workstations or serial printers may be connected to available ports in the MDC50 without the need for an additional memory increment. Current WP guidelines suggest 1 printer for every 2 workstations. Workstations and printers beyond these five (5) requires the installation of an additional Workstation/Printer Interface, and additional memory (20KB per workstation). Additional disk capacity may be required for the storage of WP documents and mail items that may now be received by MAILWAY<sup>®</sup> users resident at the Distribution Center.

MPMPI-2 includes WP Software, 2246C Workstation, 50' coax cable. Requires 512K of memory.

UPGRADE JOB #	DESCRIPTION	PURCHASE PRICE	-----R E N T A L-----	
			SINGLE OR CHARGE	MONTHLY 1 YEAR

The purchase/rental charges listed include any applicable difference in prices. For purchase systems the incremental maintenance charge is also due.

UPGRADES FOR MAILWAY<sup>®</sup> HARDWARE  
MEMORY UPGRADES, MAILWAY<sup>®</sup> MDC50

UJ-542	VS-4B to VS-8B VS-4C to VS-8C	\$ 6,500	\$ 1,000	\$ 100
UJ-543	VS-4B to VS-12B VS-4C to VS-12C	10,500	1,000	100
UJ-544	VS-4B to VS-16B VS-4C to VS-16C	14,500	1,000	100
UJ-545	VS-8B to VS-12B VS-8C to VS-12C	6,500	1,000	100
UJ-546	VS-8B to VS-16B VS-8C to VS-16C	10,500	1,000	100
UJ-547	VS-12B to VS-16B VS-12C to VS-16C	6,500	1,000	100

NOTE: All orders for add-ons and upgrade equipment MUST include the work order numbers and serial numbers of the system components involved.

MODEL NUMBER	DESCRIPTION	INITIAL LICENSE FEE	MONTHLY LICENSE FEE MAILWAY <sup>®</sup> LEVEL 3	-----MONTHLY RENTAL PRICES-----			
				1 YEAR	2 YEAR	3 YEAR	5 YEAR
MCVS-3	Level 3 Distribution Center software for VS systems. Includes Enhanced Delivery Services and MAILWAY <sup>®</sup> interface to Word Processing Software. Requires MPOIS-3, MPMP-3, or MPSYS-3 at each office system (195-2143-4)	\$ 6,000	\$ 130	\$ 330	\$ 306	\$ 264	\$ 240
MOIS-3	Level 3 Distribution Point Glossaries for OIS systems. (195-2146-3)	400	N/A	N/A	N/A	N/A	N/A
OIS-50 MOIS-3	OIS-50 MOIS-3 Level 3 Distribution Point Glossaries (195-2146-9)	400	N/A	N/A	N/A	N/A	N/A
MFOIS-3	Level 3 Distribution Point software for OIS systems. (195-2151-3)	600	N/A	N/A	N/A	N/A	N/A
OIS-50 MPOIS-3	OIS-50 MPOIS-3 Level 3 Distribution Point Software (195-2151-9)	600	N/A	N/A	N/A	N/A	N/A
MPMP-3	Level 3 Distribution Point software for WP systems 20, 25, 30. (195-2147-3)	400	N/A	N/A	N/A	N/A	N/A
MPSYS-3	Level 3 Distribution Point software for System 5. (195-2148-3)	200	N/A	N/A	N/A	N/A	N/A
MPVS-3	Level 3 Distribution Point software for VS System	1,200	N/A	N/A	N/A	N/A	N/A
MPALL	Level 3 Distribution Point Software for Alliance 250 systems. Mailway <sup>®</sup> requires TC-SC-2, TC-AC-2 or TCP. (195-2516-3)	600	N/A	N/A	N/A	N/A	N/A

**NOTE:**

**FOR MCVS-3**

A data communications port on the VS computer should be dedicated to MAILWAY<sup>®</sup> so that a higher degree of unattended operation is available. If Multi-Zone or Priority 0 features are utilized, a minimum of two additional data communications ports must be reserved for MAILWAY<sup>®</sup>. This may be accomplished by a field upgrade of a 22V06-1 to a -3, or may require the purchase and installation of another 22V06-x. Additionally, the VS must have both the TCCOPY and VSCOPY utilities. 40-80KB of memory, depending on configuration guidelines, must be available.

**FOR MPMP-3, MPOIS-3, and MPSYS-3**

MAILWAY<sup>®</sup> Level 3 requires a communications controller on a WP System 5 and a system based communications controller on other WP and OIS systems. See appropriate WP/OIS price list.

NOTE: All orders for add-ons and upgrade equipment MUST include the work order numbers and serial numbers of the system components involved.



MAILWAY™  
ENTITLED SUPPORT SERVICES SUMMARY

<u>SUPPORT DESCRIPTION</u>	<u>Support Activity Codes</u>	<u>Hours Up to-</u>	<u>Class Site Loc. Wang/Cust</u>	<u># of Class Training Up to-</u>	<u>Attendees at No Charge **</u>
<b>Pre-Installation</b>					
--Pre-Installation Meeting	<u>EP01</u>	<u>4 hrs.</u>	<u>   </u> <u>X</u>	<u>   </u>	<u>   </u>
<b>Installation</b>					
--Consultation plus 2 hours for each point	<u>EI 01</u>	<u>6 hrs.</u>	<u>   </u> <u>X</u>	<u>   </u>	<u>   </u>
	<u>   </u>	<u>   </u> <u>hrs.</u>	<u>   </u> <u>X</u>	<u>   </u>	<u>   </u>
<b>Post-Installation</b>					
System Administration Course	<u>ET01</u>	<u>   </u>	<u>X</u> <u>   </u>	<u>40 hrs.</u>	<u>2 Contacts</u>
Technical Consultation	<u>EC01</u>	<u>8 hrs.</u>	<u>   </u> <u>X</u>	<u>   </u>	<u>   </u>

ENTITLED SUPPORT SERVICES DOCUMENTATION: Wang will provide one complete set of user reference documentation for each MAILWAY Distribution Center and point.

The support service specified here is Entitled Support to be delivered within 90 days of installation in accordance with Wang Policy and is provided at no additional charge with the equipment procurement. If support services not specified here are requested, the service may be provided in accordance with Wang Policies and at Wang's per call rates and terms then in effect.

\* Location of the pre-install seminar will be determined by Wang in order to best utilize Wang and customer resources.

\*\* K = Key Operator  
A = System Administrator

\*\*\* The customer is entitled to Basic Word Processing training for one Key Operator for every ten workstations procured with the initial system order.

NOTE: All orders for add-ons and upgrade equipment MUST include the work order numbers and serial numbers of the system components involved.



COMPANY CONFIDENTIAL

Effective Date: MAY 1, 1984

-Prices and equipment availability subject to change without notice-

7500T SYSTEMS  
PRODUCT LINE PRICE LIST

"THIS DOCUMENT IS THE PROPERTY OF WANG LABORATORIES, INC., AND IS INTENDED FOR INTERNAL USE ONLY. THE INFORMATION CONTAINED HEREIN IS COMPANY CONFIDENTIAL INFORMATION. THIS DOCUMENT MAY NOT BE REPRODUCED OR IT'S CONTENTS DISCLOSED WITHOUT EXPRESS AUTHORIZATION FROM THE ORIGINATOR. ADDITIONALLY IT MAY ONLY BE DISCUSSED WITH CUSTOMERS HAVING A VALID REQUIREMENT FOR THE EQUIPMENT REPRESENTED HEREIN."

WANG 7500T Series products are controlled by the Office of Munitions Control, U.S. Department of State. Any export or re-export of this equipment and its associated parts, accessories or related technical data must have an approved export license from the Department of State.

TABLE OF CONTENTS

DESCRIPTION	PAGE	EFFECTIVE DATE
Stand-Alone	2	05/01/84
Masters	2	05/01/84
OIS/Alliance Disk Drives	3	05/01/84
Optional 7500T/PC Software	4	05/01/84
Optional 7500T/MP Software	8	05/01/84
Optional 7500T/OIS Software	9	05/01/84
Optional Alliance Software	11	05/01/84
Input Peripherals	13	05/01/84
Workstations	13	05/01/84
Printers	13	05/01/84
Telecommunications Options	14	05/01/84
Communications Workstations	15	05/01/84
Upgrades/Exchanges Charts	16	05/01/84
Upgrades/Exchanges Prices	17	05/01/84
Trade-In Policy	20	05/01/84
Notes	21	05/01/84
Configuration Guides	22	05/01/84
Entitlement Summaries	25	05/01/84

INSTALLATION CHARGE

There is no installation charge for initial installation of system(s). For add-on equipment or upgrade that are not designated customer-installable there is an installation charge of 3% of the purchase price - minimum charge \$100 per order.

NOTE: All orders for add-ons and upgrade equipment MUST include the work order numbers and serial numbers of the system components involved.

WANG

COMPANY CONFIDENTIAL

MODEL  
NUMBER

DESCRIPTION

PURCHASE  
PRICE

MONTHLY  
MAINTENANCE

-----MONTHLY RENTAL PRICES-----  
1 YEAR 2 YEAR 3 YEAR 5 YEAR

**STAND-ALONE**

WP ONLY

7520T	7520T Master, Dual Diskettes, 7536-4TM Workstation, 7582T-MPS Printer	\$ 16,000	\$ 139	\$ 752	\$ 736	\$ 704	\$ 640
-------	---	-----------	--------	--------	--------	--------	--------

DIS ONLY

7505T	7505T 4 port Master, Single Diskette, 7511T 5MB Disk Drive 7536-4TM Workstation, 7582T Printer	\$ 26,500	\$ 288	\$ 1,352	\$ 1,246	\$ 1,219	\$ 1,113
-------	---	-----------	--------	----------	----------	----------	----------

7505TA	7505T 4 port Master, Single Diskette, 7510T 10MB Disk Drive, 7536-4TM Workstation, 7582T Printer	28,000	288	1,428	1,288	1,232	1,120
--------	---	--------	-----	-------	-------	-------	-------

**MASTERS**

WP ONLY

7525-3T	7525-3T Master, 7511T 5 Mega- byte Disk, Single Diskette	\$ 17,700	\$ 228	\$ 1,031	\$ 1,008	\$ 965	\$ 877
---------	---	-----------	--------	----------	----------	--------	--------

7530T	7530T Master, 7510T 10 Mega- byte Disk, Single Diskette	18,400	240	1,128	1,106	1,058	961
-------	--	--------	-----	-------	-------	-------	-----

PC ONLY

75PC-01T	PC with eight slots, 128K single diskette drive, monitor, keyboard, MS-DOS and Interpretive BASIC	\$ 4,900	\$ 26	\$ 319	\$ 270	\$ 236	N/A
----------	--	----------	-------	--------	--------	--------	-----

75PC-02T	PC with eight slots, 128K two diskette drives, monitor, key- board, MS-DOS and Interpretive BASIC	5,585	46	364	308	269	N/A
----------	--	-------	----	-----	-----	-----	-----

DIS ONLY

7515T	7515T 8 port Master, Single Diskette	\$ 9,500	\$ 86	\$ 485	\$ 447	\$ 437	\$ 399
-------	---	----------	-------	--------	--------	--------	--------

7535T	7535T 16 port Master, Single Diskette	18,000	108	918	846	828	756
-------	--	--------	-----	-----	-----	-----	-----

NOTE: All orders for add-ons and upgrade equipment MUST include the work order numbers and serial numbers of the system components involved.





MODEL NUMBER	DESCRIPTION	PURCHASE PRICE	MONTHLY MAINTENANCE	-----MONTHLY RENTAL PRICES-----			
				1 YEAR	2 YEAR	3 YEAR	5 YEAR
<u>MASTERS (continued)</u>							
<u>DIS ONLY (continued)</u>							
7540T	7540T 32 port Master, Single Diskette	\$ 21,000	\$ 144	\$ 1,071	\$ 987	\$ 966	882
<u>ALLIANCE ONLY</u>							
7550T	Alliance 7550T 32 port Master, including 128K memory, Single Diskette, Alliance operating system Software	\$ 24,000	\$ 165	\$ 1,224	\$ 1,128	\$ 1,104	1,008

DIS/ALLIANCE DISK DRIVES

All ALLIANCE 7500T systems must utilize at least one 7565-1T 80MB Drive. Please consult the configuration guide to determine master/disk compatibility and individual master drive limitations.

7510T	7510T 10MB fixed-removable disk drive	\$ 11,000	\$ 119	\$ 561	\$ 517	\$ 506	462
7511T	7511T 5MB fully removable disk drive	9,500	119	485	447	437	399
7565-1T	7565-1T 80MB fully removable disk drive (7535T, 7540T and 7550T ONLY)	18,000	199	918	846	828	756
7510TA	Second 10MB fixed-removable disk drive	11,000	119	561	517	506	462
7511TA	Second 5MB fully removable disk drive	9,500	119	485	447	437	399
7565-1TA	Additional 80MB fully removable disk drive	18,000	197	918	846	828	756

NOTE: The 7565-1T and 7565-1TA are available with the high altitude option. When ordering these options, add an "HA" to the end of the model number and \$350 to the purchase price.

7500T/PC OPTIONS

75PC-PH02T	Graphics Card	\$ 315	\$ 4	\$ 21	\$ 18	16	N/A
75PC-PH20T	Diskette Drive (5 1/4", 360K)	685	10	45	38	33	N/A
75PC-PH30T	Memory Expansion Card (128K)	660	6	43	37	32	N/A
75PC-PH31T	Memory Expansion Card (256K)	1,090	12	71	60	53	N/A
75PC-PH32T	Memory Expansion Card (512K)	2,190	18	143	121	106	N/A

NOTE: All orders for add-ons and upgrade equipment MUST include the work order numbers and serial numbers of the system components involved.

MODEL NUMBER	DESCRIPTION	PURCHASE PRICE	MONTHLY MAINTENANCE	-----MONTHLY RENTAL PRICES-----			
				1 YEAR	2 YEAR	3 YEAR	5 YEAR
7500T/PC OPTIONS (continued)							
75PC-PM40T	Remote Telecommunications Option	\$ 1,215	\$ 10	\$ 79	\$ 67	59	N/A
75PC-PM41T	Local Communications Card (including software)	2,600	10	169	143	125	N/A
75PC-PM42T	Multipoint Communications Option	675	10	44	38	33	N/A

MODEL NUMBER	DESCRIPTION	INITIAL LICENSE FEE	MONTHLY LICENSE FEE	-----MONTHLY RENTAL PRICES-----			
				1 YEAR	2 YEAR	3 YEAR	5 YEAR

OPTIONAL 7500T/PC SOFTWARE

NOTE: SOFTWARE CANNOT BE RENTED

PC-SS001	System Software Diskette Wang Menu Enhanced MS-DOS Operating System, Plus Interpretive BASIC (Included with all Systems)						
	Quantities of 1 to 19	\$ 200	N/A	N/A	N/A	N/A	N/A
	Quantities of 20 to 49	180	N/A	N/A	N/A	N/A	N/A
	Quantities of 50 to 149	170	N/A	N/A	N/A	N/A	N/A
	Quantities of 150 to 249	160	N/A	N/A	N/A	N/A	N/A
PC-SS002	UCSD-p Runtime System						
	Quantities of 1 to 19	100	N/A	N/A	N/A	N/A	N/A
	Quantities of 20 to 49	90	N/A	N/A	N/A	N/A	N/A
	Quantities of 50 to 149	85	N/A	N/A	N/A	N/A	N/A
	Quantities of 150 to 249	80	N/A	N/A	N/A	N/A	N/A
PC-SS005	CP/M 80 Emulation Software						
	Quantities of 1 to 19	240	N/A	N/A	N/A	N/A	N/A
	Quantities of 20 to 49	215	N/A	N/A	N/A	N/A	N/A
	Quantities of 50 to 149	205	N/A	N/A	N/A	N/A	N/A
	Quantities of 150 to 249	195	N/A	N/A	N/A	N/A	N/A
PC-SS010	MS-Compiled BASIC						
	Quantities of 1 to 19	295	N/A	N/A	N/A	N/A	N/A
	Quantities of 20 to 49	260	N/A	N/A	N/A	N/A	N/A
	Quantities of 50 to 149	250	N/A	N/A	N/A	N/A	N/A
	Quantities of 150 to 249	240	N/A	N/A	N/A	N/A	N/A
PC-SS011	MS-PASCAL						
	Quantities of 1 to 19	295	N/A	N/A	N/A	N/A	N/A
	Quantities of 20 to 49	260	N/A	N/A	N/A	N/A	N/A
	Quantities of 50 to 149	250	N/A	N/A	N/A	N/A	N/A
	Quantities of 150 to 249	240	N/A	N/A	N/A	N/A	N/A

NOTE: All orders for add-ons and upgrade equipment MUST include the work order numbers and serial numbers of the system components involved.





MODEL NUMBER	DESCRIPTION	INITIAL LICENSE FEE	MONTHLY LICENSE FEE	-----MONTHLY RENTAL PRICES-----			
				1 YEAR	2 YEAR	3 YEAR	5 YEAR
OPTIONAL 7500T/PC SOFTWARE (continued)							
NOTE: SOFTWARE CANNOT BE RENTED							
PC-SS012	MS-FORTRAN						
	Quantities of 1 to 19	\$ 245	N/A	N/A	N/A	N/A	N/A
	Quantities of 20 to 49	305	N/A	N/A	N/A	N/A	N/A
	Quantities of 50 to 149	290	N/A	N/A	N/A	N/A	N/A
	Quantities of 150 to 249	280	N/A	N/A	N/A	N/A	N/A
PC-SS013	MS-COBOL						
	Quantities of 1 to 19	695	N/A	N/A	N/A	N/A	N/A
	Quantities of 20 to 49	615	N/A	N/A	N/A	N/A	N/A
	Quantities of 50 to 149	585	N/A	N/A	N/A	N/A	N/A
	Quantities of 150 to 249	560	N/A	N/A	N/A	N/A	N/A
PC-SS015	PC Advanced BASIC Compiler						
	Quantities of 1 to 19	295	N/A	N/A	N/A	N/A	N/A
	Quantities of 20 to 49	260	N/A	N/A	N/A	N/A	N/A
	Quantities of 50 to 149	250	N/A	N/A	N/A	N/A	N/A
	Quantities of 150 to 249	240	N/A	N/A	N/A	N/A	N/A
PC-SS016	PC BASIC 2						
	Quantities of 1 to 19	395	N/A	N/A	N/A	N/A	N/A
	Quantities of 20 to 49	350	N/A	N/A	N/A	N/A	N/A
	Quantities of 50 to 149	335	N/A	N/A	N/A	N/A	N/A
	Quantities of 150 to 249	320	N/A	N/A	N/A	N/A	N/A
PC-SS020	PC Asynchronous Communications Option (Includes 22360W Emulation)						
	Quantities of 1 to 19	100	N/A	N/A	N/A	N/A	N/A
	Quantities of 20 to 49	90	N/A	N/A	N/A	N/A	N/A
	Quantities of 50 to 149	85	N/A	N/A	N/A	N/A	N/A
	Quantities of 150 to 249	80	N/A	N/A	N/A	N/A	N/A
PC-SS022	MICRO FOCUS, Level II COBOL Compiler						
	Quantities of 1 to 19	1,500	N/A	N/A	N/A	N/A	N/A
	Quantities of 20 to 49	1,320	N/A	N/A	N/A	N/A	N/A
	Quantities of 50 to 149	1,260	N/A	N/A	N/A	N/A	N/A
	Quantities of 150 to 249	1,200	N/A	N/A	N/A	N/A	N/A
PC-SS023	MICRO FOCUS, FORMS-2 (Requires PC-SS022)						
	Quantities of 1 to 19	150	N/A	N/A	N/A	N/A	N/A
	Quantities of 20 to 49	135	N/A	N/A	N/A	N/A	N/A
	Quantities of 50 to 149	130	N/A	N/A	N/A	N/A	N/A
	Quantities of 150 to 249	120	N/A	N/A	N/A	N/A	N/A

NOTE: All orders for add-ons and upgrade equipment MUST include the work order numbers and serial numbers of the system components involved.

MODEL NUMBER	DESCRIPTION	INITIAL LICENSE FEE	MONTHLY LICENSE FEE	-----MONTHLY RENTAL PRICES-----			
				1 YEAR	2 YEAR	3 YEAR	5 YEAR
OPTIONAL 7500T/PC SOFTWARE (continued)							
NOTE: SOFTWARE CANNOT BE RENTED							
PC-SS035	PC OIS and VS/IIS File Sharer						
	Quantities of 1 to 19	\$ 500	N/A	N/A	N/A	N/A	N/A
	Quantities of 20 to 49	440	N/A	N/A	N/A	N/A	N/A
	Quantities of 50 to 149	420	N/A	N/A	N/A	N/A	N/A
PC-SS060	2780/3780/HPS Option For PC						
	Quantities of 1 to 19	200	N/A	N/A	N/A	N/A	N/A
	Quantities of 20 to 49	180	N/A	N/A	N/A	N/A	N/A
	Quantities of 50 to 149	170	N/A	N/A	N/A	N/A	N/A
PC-SS062	3276/3275 BSC						
	Quantities of 1 to 19	400	N/A	N/A	N/A	N/A	N/A
	Quantities of 20 to 49	355	N/A	N/A	N/A	N/A	N/A
	Quantities of 50 to 149	340	N/A	N/A	N/A	N/A	N/A
PC-SS063	3276 SNA/SDLC Emulation						
	Quantities of 1 to 19	400	N/A	N/A	N/A	N/A	N/A
	Quantities of 20 to 49	355	N/A	N/A	N/A	N/A	N/A
	Quantities of 50 to 149	340	N/A	N/A	N/A	N/A	N/A
PC-WSNT-MS	PC WSN Multipoint Secondary Transport						
	Quantities of 1 to 19	\$ 250	N/A	N/A	N/A	N/A	N/A
	Quantities of 20 to 49	220	N/A	N/A	N/A	N/A	N/A
	Quantities of 50 to 149	210	N/A	N/A	N/A	N/A	N/A
PC-WSNT-PP	PC WSN Point-Point Transport						
	Quantities of 1 to 19	250	N/A	N/A	N/A	N/A	N/A
	Quantities of 20 to 49	220	N/A	N/A	N/A	N/A	N/A
	Quantities of 50 to 149	210	N/A	N/A	N/A	N/A	N/A
PC-WSNT-X25	PC WSN X.25 Transport						
	Quantities of 1 to 19	250	N/A	N/A	N/A	N/A	N/A
	Quantities of 20 to 49	220	N/A	N/A	N/A	N/A	N/A
	Quantities of 50 to 149	210	N/A	N/A	N/A	N/A	N/A
PC-WSNT-X25	PC WSN X.25 Transport						
	Quantities of 1 to 19	250	N/A	N/A	N/A	N/A	N/A
	Quantities of 20 to 49	220	N/A	N/A	N/A	N/A	N/A
	Quantities of 50 to 149	210	N/A	N/A	N/A	N/A	N/A
PC-WSNT-X25	PC WSN X.25 Transport						
	Quantities of 1 to 19	250	N/A	N/A	N/A	N/A	N/A
	Quantities of 20 to 49	220	N/A	N/A	N/A	N/A	N/A
	Quantities of 50 to 149	210	N/A	N/A	N/A	N/A	N/A
PC-WSNT-X25	PC WSN X.25 Transport						
	Quantities of 1 to 19	250	N/A	N/A	N/A	N/A	N/A
	Quantities of 20 to 49	220	N/A	N/A	N/A	N/A	N/A
	Quantities of 50 to 149	210	N/A	N/A	N/A	N/A	N/A
PC-WSNT-X25	PC WSN X.25 Transport						
	Quantities of 1 to 19	250	N/A	N/A	N/A	N/A	N/A
	Quantities of 20 to 49	220	N/A	N/A	N/A	N/A	N/A
	Quantities of 50 to 149	210	N/A	N/A	N/A	N/A	N/A

WANG SYSTEMS NETWORKING SOFTWARE

NOTE: All orders for add-ons and upgrade equipment MUST include the work order numbers and serial numbers of the system components involved.

7500T/ 6 - 6

COMPANY CONFIDENTIAL  
REPLACES: 02/01/84  
EFFECTIVE: 05/01/84





MODEL NUMBER	DESCRIPTION	INITIAL LICENSE FEE	MONTHLY LICENSE FEE	-----MONTHLY RENTAL PRICES-----			
				1 YEAR	2 YEAR	3 YEAR	5 YEAR
WANG SYSTEMS NETWORKING SOFTWARE (continued)							
PC-WSNS-BSS	PC BASIC Support Services for WSN file transfer and VS DP Terminal Emulation						
	Quantities of 1 to 19	\$ 100	N/A	N/A	N/A	N/A	N/A
	Quantities of 20 to 49	90	N/A	N/A	N/A	N/A	N/A
	Quantities of 50 to 149	85	N/A	N/A	N/A	N/A	N/A
	Quantities of 150 to 249	80	N/A	N/A	N/A	N/A	N/A
195-2781-9	PC VT-100 Emulation						
	Quantities of 1 to 19	200	N/A	N/A	N/A	N/A	N/A
	Quantities of 20 to 49	180	N/A	N/A	N/A	N/A	N/A
	Quantities of 50 to 149	170	N/A	N/A	N/A	N/A	N/A
	Quantities of 150 to 249	160	N/A	N/A	N/A	N/A	N/A
OPTIONAL 7500T PC APPLICATION SOFTWARE							
NOTE: SOFTWARE CANNOT BE RENTED							
PC-AS001	PC Multiplan						
	Quantities of 1 to 19	\$ 245	N/A	N/A	N/A	N/A	N/A
	Quantities of 20 to 49	220	N/A	N/A	N/A	N/A	N/A
	Quantities of 50 to 149	210	N/A	N/A	N/A	N/A	N/A
	Quantities of 150 to 249	200	N/A	N/A	N/A	N/A	N/A
PC-AS002	PC Word Processing						
	Quantities of 1 to 19	400	N/A	N/A	N/A	N/A	N/A
	Quantities of 20 to 49	355	N/A	N/A	N/A	N/A	N/A
	Quantities of 50 to 149	340	N/A	N/A	N/A	N/A	N/A
	Quantities of 150 to 249	320	N/A	N/A	N/A	N/A	N/A
PC-AS002-2	PC Advanced Word Processing						
	Quantities of 1 to 19	500	N/A	N/A	N/A	N/A	N/A
	Quantities of 20 to 49	440	N/A	N/A	N/A	N/A	N/A
	Quantities of 50 to 149	420	N/A	N/A	N/A	N/A	N/A
	Quantities of 150 to 249	400	N/A	N/A	N/A	N/A	N/A
PC-AS003	PC Business Graphics						
	Quantities of 1 to 19	300	N/A	N/A	N/A	N/A	N/A
	Quantities of 20 to 49	265	N/A	N/A	N/A	N/A	N/A
	Quantities of 50 to 149	255	N/A	N/A	N/A	N/A	N/A
	Quantities of 150 to 249	240	N/A	N/A	N/A	N/A	N/A
PC-AS004	PC Data Base						
	Quantities of 1 to 19	650	N/A	N/A	N/A	N/A	N/A
	Quantities of 20 to 49	575	N/A	N/A	N/A	N/A	N/A
	Quantities of 50 to 149	550	N/A	N/A	N/A	N/A	N/A
	Quantities of 150 to 249	520	N/A	N/A	N/A	N/A	N/A

NOTE: All orders for add-ons and upgrade equipment MUST include the work order numbers and serial numbers of the system components involved.



MODEL NUMBER	DESCRIPTION	INITIAL LICENSE FEE	MONTHLY LICENSE FEE	-----MONTHLY RENTAL PRICES-----			
				1 YEAR	2 YEAR	3 YEAR	5 YEAR

OPTIONAL 7500T PC APPLICATION SOFTWARE (continued)

NOTE: SOFTWARE CANNOT BE RENTED

PC-AS005	PC Notebook						
	Quantities of 1 to 19	\$ 200	N/A	N/A	N/A	N/A	N/A
	Quantities of 20 to 49	180	N/A	N/A	N/A	N/A	N/A
	Quantities of 50 to 149	170	N/A	N/A	N/A	N/A	N/A
PC-AS009	PC OFFICE						
	Quantities of 1 to 19	495	N/A	N/A	N/A	N/A	N/A
	Quantities of 20 to 49	440	N/A	N/A	N/A	N/A	N/A
	Quantities of 50 to 149	420	N/A	N/A	N/A	N/A	N/A
PC-AS012	PC Multistation						
	Quantities of 1 to 19	295	N/A	N/A	N/A	N/A	N/A
	Quantities of 20 to 49	260	N/A	N/A	N/A	N/A	N/A
	Quantities of 50 to 149	250	N/A	N/A	N/A	N/A	N/A
PC-CS001	Software Productivity Package- PC Multiplan (PC-AS001), PC Word Processing (PC-AS002), and Asynchronous Communica- tions (PC-SS020)						
	Quantities of 1 to 19	650	N/A	N/A	N/A	N/A	N/A
	Quantities of 20 to 49	575	N/A	N/A	N/A	N/A	N/A
	Quantities of 50 to 149	550	N/A	N/A	N/A	N/A	N/A
PC-CS003	MICRO FOCUS, Level II COBOL Programming Environment (In- cludes MICRO FOCUS, Level II COBOL, FORMS-2 and ANIMATOR)						
	Quantities of 1 to 19	1,750	N/A	N/A	N/A	N/A	N/A
	Quantities of 20 to 49	1,540	N/A	N/A	N/A	N/A	N/A
	Quantities of 50 to 149	1,470	N/A	N/A	N/A	N/A	N/A
PC-CS003	MICRO FOCUS, Level II COBOL Programming Environment (In- cludes MICRO FOCUS, Level II COBOL, FORMS-2 and ANIMATOR)						
	Quantities of 1 to 19	1,750	N/A	N/A	N/A	N/A	N/A
	Quantities of 20 to 49	1,540	N/A	N/A	N/A	N/A	N/A
	Quantities of 50 to 149	1,470	N/A	N/A	N/A	N/A	N/A

OPTIONAL 7500T/WP SOFTWARE WITHOUT QUANTITY DISCOUNTS

S0-1	Sort Option (701-2395)	\$ 1,000	N/A	\$ 47	\$ 46	\$ 44	\$ 40
S0-2	Math Support Package(701-2396)	1,000	N/A	47	46	44	40
S0-3	System Security (Not an op- tional Software Package for WPS 7524-3T) (701-2397)	2,000	N/A	94	92	88	80

NOTE: All orders for add-ons and upgrade equipment MUST include the work order numbers and serial numbers of the system components involved.





MODEL NUMBER	DESCRIPTION	INITIAL LICENSE FEE	MONTHLY LICENSE FEE	-----MONTHLY RENTAL PRICES-----			
				1 YEAR	2 YEAR	3 YEAR	5 YEAR
<u>OPTIONAL 7500T/OIS SOFTWARE WITHOUT QUANTITY DISCOUNTS</u>							
S0-6	Office BASIC Compiler (195-2118-3)	\$ 3,000	N/A	\$ 141	\$ 138	\$ 132	120
195-2116-3	OIS Advanced Functions	N/A	N/A	N/A	N/A	N/A	N/A
195-2172-3	Management Statistics System - WP Productivity (OIS 140/145A, 7535T/7540T with 80MB drive only) (195-2172-3)	1,000	N/A	47	46	44	40
OIS-MULTI	Multiplan Electronic Spread Sheet Program for OIS (Requires OIS-CPM) (64K CRT required) (195-2340-3)	600	N/A	N/A	N/A	N/A	N/A
<u>7500T/OIS EDITOR PACKAGE</u>							
OIS-WP-PLUS	Optional Advanced Word Processing Package for OIS 115-2, -3, -4, 140, 145A (Not available on OIS 105, 125, 125A, 130 and 130A) (195-2760-3)	\$ 2,000	17	\$ 110	\$ 102	\$ 88	80

COMPANY CONFIDENTIAL  
 WANG

NOTE: All orders for add-ons and upgrade equipment MUST include the work order numbers and serial numbers of the system components involved.

MODEL  
NUMBER

DESCRIPTION

INITIAL  
LICENSE  
FEE

MONTHLY  
LICENSE  
FEE

-----MONTHLY RENTAL PRICES-----  
1 YEAR 2 YEAR 3 YEAR 5 YEAR

OPTIONAL 7500T/OIS SOFTWARE WITH QUANTITY DISCOUNTS

THIS DISCOUNT SCHEDULE APPLIES TO THE FOLLOWING OPTIONAL 7500T/OIS AND OPTIONAL ALLIANCE SOFTWARE:

	DESCRIPTION	QUANTITY ORDERED		DISCOUNT						
		1 - 2	3 - 5	6 - 10	11 - 20	OVER 20	1 YEAR	2 YEAR	3 YEAR	5 YEAR
OIS-READ	Readability Analysis System (48K or 64K CRT required) (195-2173-3)	\$ 3,000	\$ 30	\$ 141	\$ 138	\$ 132	\$ 120			
DIS-CPM	CP/M Software for OIS (Re- quires 64K CRT) (195-2316-3)	1,000	10	47	46	44	40			
OIS-DOCBUILDER	Paragraph Retrieval Software (Requires 64K CRT)(195-2320-3)	1,000	10	47	46	44	40			
SO-8	List Processing for OIS (48K or 64K required) (English Only) (195-2156-3)	1,300	10	62	60	58	52			
OIS-SPELL	Software for spelling verifi- cation (OIS 115-3/-4, 140/ 145A, 7515T/7535T/7540T only.) (Requires 64K workstation) (195-2207-3)	1,000	10	47	46	44	40			
OIS-SMSPELL	Spelling verification software based on 30,000 word dictio- nary. Runs on OIS 105, 115-2, 7505T/7515T (Requires 64K workstation) (195-2391-3)	500	5	24	23	22	20			
OIS-SLP	Small List Processing for OIS (48K or 64K CRT required) (English Only) (195-2438-3)	750	5	36	35	33	30			
OIS-3271E	3271 Emulation Software (Re- quires OIS-TC for OIS Systems or TC-SC/AC-2 for 7500T Sys- tems) (195-2243-3)	2,500	25	118	115	110	100			
OIS-BATCH	2780/3780/MPS Communications (Requires OIS-TC for OIS Sys- tems or TC-SC/AC-2T for 7500T Systems) (195-2619-3)	1,300	13	71	65	56	52			

NOTE: All orders for add-ons and upgrade equipment MUST include the work order numbers and serial numbers of the system components involved.



# 7500T SYSTEMS

MODEL NUMBER	DESCRIPTION	INITIAL LICENSE FEE	MONTHLY LICENSE FEE	-----MONTHLY RENTAL PRICES-----			
				1 YEAR	2 YEAR	3 YEAR	5 YEAR
<u>OPTIONAL 7500T/OIS SOFTWARE WITH QUANTITY DISCOUNTS</u> (continued)							
OIS-TTE	Teletype Emulation Software (Requires OIS-TC for OIS Systems or TC-SC/AC-2T for 7500T Systems) (195-2618-3)	\$ 1,200	\$ 12	\$ 65	\$ 60	\$ 52	48
OIS-MSMT-MS	OIS Multipoint Secondary Transport	1,000	10	55	51	44	40
OIS-MSMT-PP	OIS Point-Point Transport	1,500	15	83	77	66	60
OIS-MSNS-LGN	OIS VS Terminal Emulation Service	400	4	22	21	18	16
OIS-MSNS-FT	OIS File Transfer Service	600	6	33	31	27	24

### OPTIONAL ALLIANCE SOFTWARE WITH QUANTITY DISCOUNTS

An Audio Workstation is not available for the 7500T ALLIANCE Systems, for this reason the AL-VH Autodial feature and AL-TIME Autodial feature are not functional on these systems. AL-VOICE is not available in any form.

AL-VH	Visual Memory Autodial (Requires audio workstation) (195-2334-3)	\$ 6,000	\$ 60	\$ 282	\$ 276	\$ 264	240
AL-TIME	Time Management Calendar Directory Autodial (Requires audio workstation) Messaging Voicegrams (Requires audio workstation) (195-2235-3)	2,000	20	94	92	88	80
AL-NOTES	Notebook (195-2236-3)	1,000	10	47	46	44	40
AL-CPM	Alliance CP/M (195-2238-3)	1,000	10	47	46	44	40
AL-BASIC	Alliance Basic (195-2239-3)	3,000	30	141	138	132	120
AL-3271E	3271 Emulation Software (Requires OIS-TC) (195-2243-3)	2,500	25	118	115	110	100
AL-BATCH	2780/3780/MPS Emulation Software (Requires OIS-TC for Alliance Systems or TC-SC/AC-2T for 7500T Systems)(195-2244-3)	1,500	15	71	69	66	60

NOTE: All orders for add-ons and upgrade equipment MUST include the work order numbers and serial numbers of the system components involved.

MODEL NUMBER	DESCRIPTION	INITIAL LICENSE FEE	MONTHLY LICENSE FEE	-----MONTHLY RENTAL PRICES-----			
				1 YEAR	2 YEAR	3 YEAR	5 YEAR

OPTIONAL ALLIANCE SOFTWARE WITH QUANTITY DISCOUNTS (continued)

An Audio Workstation is not available for the 7500T ALLIANCE Systems, for this reason the AL-VM Autodial feature and AL-TIME Autodial feature are not functional on these systems. AL-VOICE is not available in any form.

AL-TTE	Software package providing asynchronous communication facilities on Alliance and Teletypewriter emulation. (Requires OIS-TC for Alliance Systems or TC-SC/AC-2T for 7500T Systems (195-2454-3))	\$ 1,500	\$ 15	\$ 71	\$ 69	\$ 66	\$ 60
AL-LOGON	Alliance Security Logon II (195-2514-3)	500	5	24	23	22	20

The following Alliance Software is NOT quantity discounted.

AL-MULTI	Multiplan Electronic Spread Sheet for Alliance 250, 7550T Quantity discounts not offered on this model (195-2341-3)	600	N/A	N/A	N/A	N/A	N/A
----------	--	-----	-----	-----	-----	-----	-----

7500T/ALLIANCE EDITOR PACKAGE

AL-WP-PLUS	Optional Advanced Word Processing Package for Alliance Systems (195-2761-3)	\$ 2,000	\$ 17	\$ 110	\$ 102	\$ 88	\$ 80
------------	---	----------	-------	--------	--------	-------	-------

7500T/ALLIANCE NETWORKING

ALI-W5NT-MS	Alliance Multipoint Secondary Transport	\$ 1,000	\$ 10	\$ 55	\$ 51	\$ 44	\$ 40
ALI-W5NT-PP	Alliance Point-Point Transport	1,500	15	83	77	66	60

Quantity Discounts for Software

Multiple copies of each optional software package will qualify for a quantity discount if they are ordered on a single workorder for delivery to a single address. Customers taking advantage of the quantity discount will be entitled to a single training class for the software ordered.

NOTE: All orders for add-ons and upgrade equipment MUST include the work order numbers and serial numbers of the system components involved.

7500T/ 6 - 12

COMPANY CONFIDENTIAL  
REPLACES: 02/01/84  
EFFECTIVE: 05/01/84



# 7500T SYSTEMS

MODEL NUMBER	DESCRIPTION	PURCHASE PRICE	MONTHLY MAINTENANCE	-----MONTHLY RENTAL PRICES-----			
				1 YEAR	2 YEAR	3 YEAR	5 YEAR
<u>INPUT PERIPHERALS</u>							
WP/OIS ONLY							
OCR-T	Optical Character Reader Interface	\$ 2,500	\$ 32	\$ 128	\$ 118	\$ 115	105
<u>WORKSTATIONS</u>							
(All Include Horizontal Scroll)							
WP/OIS/ALLIANCE							
This workstation may be upgraded to a TC configuration.							
7536-4TN	64K CRT/Keyboard Workstation with Numeric Keypad	\$ 5,700	\$ 35	\$ 291	\$ 263	\$ 251	228
OIS ONLY							
7501T	Archiving workstations, eight slots, Local Communications Option (including software), 128K, single disk, monitor, and keyboard	\$ 7,500	\$ 36	\$ 488	\$ 413	\$ 360	N/A
7556CT	64K CRT/Keyboard Workstation for WP/DP applications within Remote WangNet	5,700	35	291	263	251	228
<u>PRINTERS</u>							
OIS/ALLIANCE							
7582T	35 CPS Daisy wheel printer with 64K memory	\$ 7,500	\$ 62	\$ 383	\$ 353	\$ 345	315
WP							
7582T-WPS	35 CPS Daisy wheel printer with 64K memory. Incorporates a special PROM to support the DSF-IT on WPS.	\$ 7,500	\$ 62	\$ 383	\$ 353	\$ 345	315
WP/OIS/ALLIANCE							
7581WC-1T	35 CPS Wide Carriage Daisy Wheel Printer with 64K memory	\$ 8,500	\$ 62	\$ 400	\$ 391	\$ 374	340

NOTE: All orders for add-ons and upgrade equipment MUST include the work order numbers and serial numbers of the system components involved.

MODEL  
NUMBER

DESCRIPTION

PURCHASE  
PRICEMONTHLY  
MAINTENANCE-----MONTHLY RENTAL PRICES-----  
1 YEAR 2 YEAR 3 YEAR 5 YEARDUAL SHEET FEEDERSWP/DIS/ALLIANCE

The following Dual Sheet Feeder uses paper size:  
8 1/2" x 11" to 8 1/2" x 14" or  
21.59 cm x 27.94 cm to 21.59 cm x 35.56 cm

DSF-1T	Dual Sheet Feeder for 7582T or 7582T-WPS Printers.	\$ 2,100	\$ 27	\$ 108 \$	99 \$	97 \$	89
DSF-1IT	International Dual Sheet Feeder for 7582T or 7582T-WPS Printers	2,100	27	108	99	97	89

FORMS TRACTOR

7582T-FT	Mono-Directional Forms Tractor for 7582T or 7582T-WPS Printers.	\$ 250	N/A	\$ 13 \$	12 \$	11 \$	10
----------	---	--------	-----	----------	-------	-------	----

TELECOMMUNICATIONS OPTIONS

Customers must supply the modems and crypto equipment for all communications controllers.

WP/DIS ONLY

TCB-T	System-based, external communications controller. WPS, 2780 and 3780 Emulations	\$ 3,500	\$ 32	\$ 179 \$	165 \$	161 \$	147
-------	---	----------	-------	-----------	--------	--------	-----

OIS/ALLIANCE ONLY

TC-SC-2T	Internal Telecommunications Controller for 7500T series OIS and Alliance. OIS requires either TC-3271E, OIS-BATCH, OIS-TTE, OIS-RM, or OIS-RMP software. Alliance requires either AL-3271E, AL-BATCH or AL-TTE software.	\$ 2,250	\$ 32	\$ 115 \$	106 \$	104 \$	95
TC-AC-2T	Internal Telecommunications controller for 7500T series OIS and Alliance (For a second TC channel) for OIS or Alliance	2,250	32	115	106	104	95

NOTE: All orders for add-ons and upgrade equipment MUST include the work order numbers and serial numbers of the system components involved.

7500T/ 6 - 14

COMPANY CONFIDENTIAL  
REPLACES: 02/01/84  
EFFECTIVE: 05/01/84



MODEL NUMBER	DESCRIPTION	PURCHASE PRICE	MONTHLY MAINTENANCE	-----MONTHLY RENTAL PRICES-----			
				1 YEAR	2 YEAR	3 YEAR	5 YEAR
<u>COMMUNICATIONS WORKSTATIONS</u>							
Customers must supply the modems and crypto equipment for all communications workstations.							
WP/OIS ONLY							
TC-7536-4TN	64K CRT/Keyboard Workstation with Numeric Keypad, Horizontal Scroll, WPS, 2780, 3780, 2741 and TTY (ASCII) Emulations.	\$ 6,450	\$ 60	\$ 329	\$ 297	\$ 284	\$ 258
DIS ONLY							
TC-7556CT	64K CRT/Keyboard Workstation for WP/DP applications within Remote WangNet with WPS, 2780/3780, 2741 and TTY (ASCII) Emulations	\$ 6,450	\$ 60	\$ 329	\$ 297	\$ 284	\$ 258
<u>MASTER OPTIONS</u>							
OIS/ALLIANCE ONLY							
7529T	1/4" Archiving Cartridge Tape Drive	\$ 8,000	\$ 66	\$ 408	\$ 368	\$ 352	\$ 320
7561T	Wang inter system exchange (WISE) (OIS or Alliance)	6,500	67	332	306	299	273
EM-OIS-T	Extended memory option for OIS (Additional 64K) Required for WISE, 3271E	2,000	30	102	94	92	84

NOTE: All orders for add-ons and upgrade equipment MUST include the work order numbers and serial numbers of the system components involved.



7500T MPS UPGRADES/EXCHANGES

FROM/TO	7525-3T	7530T
7520T	UJ-2148	UJ-2149
7525-3T	N/A	UJ-1090

7500T DIS UPGRADES/EXCHANGES

FROM/TO	7515T	7535T	7540T	7550T
7505T	UJ-1201	UJ-1202	UJ-1203	UJ-1204
7515T	N/A	UJ-1205	UJ-1206	UJ-1207
7535T	N/A	N/A	UJ-1208	UJ-1209
7540T	N/A	N/A	N/A	UJ-1210

7500T WORKSTATION UPGRADES

FROM/TO	7536-4T	7556CT
7536-1T	UJ-1212	N/A
7536-2T	UJ-1213	N/A
7536-4T(N)	N/A	UJ-1267

N/A = Not Available

NOTE: All orders for add-ons and upgrade equipment MUST include the work order numbers and serial numbers of the system components involved.



# 7500T SYSTEMS

## 7500T WORKSTATION UPGRADES TO TC CONFIGURATIONS

FROM/TO	TC-7536-2T	TC-7536-4T(N)	TC-7556TC
7536-1T	N/A	UJ-1215	N/A
7536-2T	UJ-1216	UJ-1217	N/A
7536-4T(N)	N/A	UJ-1218	N/A
TC-7536-2T	N/A	UJ-1233	N/A
TC-7536-4T(N)	N/A	N/A	UJ-1267

N/A = Not Available

UPGRADE JOB #	DESCRIPTION	PURCHASE PRICE	-----R E N T A L-----	
			SINGLE CHARGE	OR MONTHLY 1 YEAR

The purchase/rental charges listed include any applicable difference in prices. For purchase systems the incremental maintenance charge is also due.

### UPGRADES/EXCHANGE PRICING

UJ-2148 and UJ-2149 require equipment swap out. All other 7500T master upgrades do not require equipment swap outs.

UJ-2148	7520T to 7525-3T (Upgrade involves an exchange of serialized equipment)	\$ 13,600	\$ 600	\$ 60
UJ-2149	7520T to 7530T (Upgrade involves an exchange of serialized equipment)	14,300	600	60
UJ-1201	7505T to 7515T	7,950	600	60
UJ-1202	7505T to 7535T	16,450	600	60
UJ-1203	7505T to 7540T	19,450	600	60
UJ-1204	7505T to 7550T	22,450	600	60
UJ-1090	7525-3T to 7530T (Upgrade involves an exchange of serialized equipment)	1,300	600	60

NOTE: All orders for add-ons and upgrade equipment MUST include the work order numbers and serial numbers of the system components involved.

UPGRADE JOB #	DESCRIPTION	PURCHASE PRICE	SINGLE CHARGE	OR	MONTHLY 1 YEAR
------------------	-------------	-------------------	------------------	----	-------------------

The purchase/rental charges listed include any applicable difference in prices. For purchase systems the incremental maintenance charge is also due.

UPGRADES/EXCHANGE PRICING (continued)  
Master (continued)

UJ-1205	7515T to 7535T	\$ 9,100	\$ 600	\$ 60
UJ-1206	7515T to 7540T	12,100	600	60
UJ-1207	7515T to 7550T	15,100	600	60
UJ-1208	7535T to 7540T	3,600	600	60
UJ-1209	7535T to 7550T	6,600	600	60
UJ-1210	7540T to 7550T	3,600	600	60
Workstation				
UJ-1212	7536-1T to 7536-4T	\$ 1,620	\$ 600	\$ 60
UJ-1213	7536-2T to 7536-4T	1,260	600	60
UJ-1215	7536-1T to TC-7536-4T	3,240	600	60
UJ-1216	7536-2T to TC-7536-2T	2,160	600	60
UJ-1217	7536-2T to TC-7536-4T	2,880	600	60
UJ-1218	7536-4T(M) to TC-7536-4T(N)	2,160	600	60
UJ-1233	TC-7536-2T to TC-7536-4T	1,260	600	60
UJ-1267	TC-7536-4T (M) to TC-7556CT or 7536-4T (N) to 7556CT	1,810	900	90
Printer				
UJ-1220	7581WT to 7581W-1T	\$ 600	\$ 600	\$ 60
UJ-1222	7581WCT to 7581WC-1T	600	600	60
UJ-1269	7582T to 7582T-WPS	1,000	500	50
UJ-1270	7582T-WPS to 7582T	1,000	500	50
Keyboard				
UJ-1261	Standard Keyboard to Standard Keyboard with MX-1T Numeric Keypad (All Workstations)	\$ 650	N/A	N/A

NOTE: All orders for add-ons and upgrade equipment MUST include the work order numbers and serial numbers of the system components involved.



**7500T  
SYSTEMS**

UPGRADE JOB #	DESCRIPTION	PURCHASE PRICE	-----R E N T A L-----	
			SINGLE CHARGE	OR MONTHLY 1 YEAR
The purchase/rental charges listed include any applicable difference in prices. For purchase systems the incremental maintenance charge is also due.				
	Disk Drive			
UJ-1266	7511T 5MB Disk Drive to 7510T 10MB Disk Drive	\$ 2,500	\$ 1,000	\$ 100
	7500T/PC SOFTWARE			
UJ-3199	Upgrade to Enhanced MS/DOS Op- erating System	\$ 100	N/A	N/A
UJ-3200	Upgrade to Advanced PC Word Processing	150	N/A	N/A
UJ-3201	Upgrade to Enhanced Local Com- munications	50	N/A	N/A

NOTE: All orders for add-ons and upgrade equipment MUST include the work order numbers and serial numbers of the system components involved.

TRADE-IN POLICY

Upgrade job numbers have been assigned to all combinations of systems and peripheral upgrades permissible. If a purchase customer wants to move from a 7500T WPS to an 7500T DIS/Alliance, it must be done via a trade-in. Likewise, 7526 workstations must be traded in for 7536 workstations to be used on 7500T DIS/Alliance systems.

Below is an adaptation of the current trade-in policy indicating the allowances:

Wang Laboratories, Inc. will accept certain Wang-manufactured items for trade-in credit when accompanied by a customer order for the purchase of new equipment as specified below. The trade-in allowance provides for the following percentage of credit on the equipment being traded in which can be applied to the current list price of the new equipment being purchased. For the purposes of trade-in, specific base purchase prices are listed in the following table under point two (2). These base purchase prices apply only to systems procured via open market transactions. For systems procured via a negotiated contract or under the GSA contract, that contract purchase price will be utilized as the base purchase price.

1. ALLOWANCE FROM BASE PURCHASE PRICE OF OLD EQUIPMENT

<u>IN THE FIRST YEAR</u>	<u>BETWEEN FIRST AND SECOND YEAR</u>	<u>BETWEEN SECOND AND THIRD YEAR</u>	<u>BEYOND THREE YEARS</u>
40%	30%	20%	\$50/Serialized Item

2. BASE PURCHASE PRICE FOR TRADE-IN ALLOWANCE

<u>EQUIPMENT</u>	<u>BASE PURCHASE PRICE</u>
7520T (Master and Diskette Drive)	\$ 19,000
7525-3T (Master and Disk Drive)	17,700
7530T (Master and Disk Drive)	18,400
7525-3T (Master only, Disk Drive retained)	8,200
7530T (Master only, Disk Drive retained)	7,400
7526HT Workstation	6,100

- Trade-in credit cannot exceed 50% of the purchase price of the new equipment ordered.
- The trade-in schedule covers serialized equipment, including options, memory, and upgrades which are an integral part of the system.
- Trade-in credit applies only to equipment purchased from Wang Laboratories, Inc. or a duly authorized agent. The order must be accompanied by a copy of the original purchase order or other proof of ownership of the equipment to be traded in.
- Age of equipment is determined by the date the new order is received at Wang from the date of the original shipment of the traded-in equipment.
- Trade-in credit does not apply to the following items:

Cables	Furniture
Supplies	Software
Demonstration equipment	Equipment over three years old
Inoperative damaged items	Equipment that has been modified by unauthorized persons
Stolen equipment	Rental equipment
Refurbished equipment	

NOTE: All orders for add-ons and upgrade equipment MUST include the work order numbers and serial numbers of the system components involved.



8. Trade in credit will not be given for the following types of conversions:

Owned WP/DIS/Alliance to Rented 7500T  
Rented WP/DIS/Alliance to Rented 7500T  
Rented WP/DIS/Alliance to Purchased 7500T

9. Conversion of rented 7500T to purchased 7500T system will conform to the standard Wang Purchase Option policy as outlined in the Rental section of this price list.

NOTE: 1. Products which are NOT PRESENTLY AVAILABLE on 7500T systems are:

- Photocomposition option
- Matrix or Line Printers
- Audio Workstations
- Ergo Workstations
- Paper Tape Punch
- Archiving Workstations
- Alliance Communications Workstations

2. Deliveries will be 30-60 days ARO.

3. No 7500T Equipment may be used with furniture designed for "built-in" installation. Use MST-1 tables for most applications.

4. Unless otherwise noted, prices for all standard software and supplies are the same as for standard WPS systems and are compatible with 7500T equipment. See product data sheets for further information.

5. 7500T orders should list customer requirements regarding 50 or 60 cycle.

6. 7500T cables and supplies can be ordered through the Wang Supplies Catalog.

7. 7500T DIS and Alliance peripherals can be located up to 1000' (305 m) from the Master. 7500T WPS peripherals can only be 500' (152.4 m) from the Master.

NOTE: All orders for add-ons and upgrade equipment MUST include the work order numbers and serial numbers of the system components involved.

SYSTEM SUMMARY FOR 7500T WP SERIES

	7520T	7525-3T	7530T
TOTAL PERIPHERALS	6	14	14
MAXIMUM NUMBER WORKSTATIONS	3	13	13
MAXIMUM NUMBER PRINTERS	5	13	13

Any Telecommunications device, either workstation or system-based, uses one (1) port. The device counts as one (1) towards the total number of peripherals.

7500T WP SERIES  
CONFIGURATION/COMPATIBILITY GUIDE

	7520T	7525-3T	7530T
<u>Input Peripherals</u>			
OCR-T	X	X	X
<u>Software</u>			
S0-1	X	X	X
S0-2	X	X	X
S0-3	X		X
<u>Workstations</u>			
7536-4TN	X	X	X
<u>Printers</u>			
7582T	X	X	X
7581MC-1T	X	X	X
<u>Sheet Feeder</u>			
DSF-1T for 7582T ONLY*	X	X	X
<u>TC Controllers</u>			
TCB-T	X	X	X
<u>Communications Workstations</u>			
TC-7536-4TN	X	X	X

\*Single Sheet Feed capability only on 7500T WP series.

NOTE: All orders for add-ons and upgrade equipment MUST include the work order numbers and serial numbers of the system components involved.



# 7500T SYSTEMS

## SYSTEM SUMMARY FOR OIS/ALLIANCE PRODUCT LINE

	7505T	7515T	7535T	7540T	7550T <sup>5</sup>
Maximum <sup>1</sup> # ports	4	8	16	32	32
Maximum Workstations	4	8	16	24	24
Maximum Printers	3	7	15	31	31
Maximum <sup>2,3,4</sup> Drives	2 2x5 MB	2 2x5 MB or 2x10 MB	3 1x80 MB + 2x10 MB or 2x5 MB	4 2x80 MB + 2x10 MB or 2x5 MB	4/5 3x80 MB or 4x80 MB + 2x10 MB or 2x5 MB
Maximum Storage (MB)	10	10/20	90/100	170/180	250/260/320

**NOTES:**1. Any Telecommunications device, either workstation or system-based, uses one (1) port. The device counts as one (1) towards the total number of peripherals.

2. No more than two (2) 5/10 MB drives may be used on any single 7500T master.
3. 5 and 10 MB drives may not be mixed on the same master, i.e. both drives must be 5 MB or both must be 10 MB.
4. No more than four (4) 80 MB drives may be used on a single 7550T master.
5. At least one (1) 80 MB drive is required for each 7550T master.

### 7500T OIS/ALLIANCE SERIES CONFIGURATION/COMPATIBILITY GUIDE

See Sales and Rental sections of this manual for description of Alliance software packages available on 7550T

	7505T	7515T	7535T	7540T	7550T
<u>Input Peripherals</u>					
OCR-T	X	X	X	X	

**NOTE:** All orders for add-ons and upgrade equipment MUST include the work order numbers and serial numbers of the system components involved.



7500T OIS/ALLIANCE SERIES  
CONFIGURATION/COMPATIBILITY GUIDE

See Sales and Rental sections of this manual for description of Alliance software packages available on 7550T

	7505T	7515T	7535T	7540T	7550T
<b>Software</b>					
SO-6	X	X	X	X	
SO-8	X	X	X	X	
195-2116-3	X	X	X	X	
195-2172-3	X	X	X	X	
195-2173-3	X	X	X	X	
OIS-SPELL	X	X	X	X	
OIS-MULTI	X	X	X	X	
OIS-SMSPPELL	X	X	X	X	
OIS-SLP	X	X	X	X	
TC-3271E	X	X	X	X	
<b>AL-VH</b>					
AL-TIME					X
AL-NOTES					X
AL-CPM					X
AL-BASIC					X
AL-LIST					X
AL-MULTI					X
AL-3271E					X
AL-BATCH					X
AL-TTE					X
<b>Workstations</b>					
7536-2T	X	X	X	X	X
7536-4TN	X	X	X	X	X
7556CT	X	X	X	X	X
<b>Printers</b>					
7582T	X	X	X	X	X
7581HC-1T	X	X	X	X	X
<b>Sheet Feeder</b>					
DSF-1T for 7582T	X	X	X	X	X
<b>TC Controllers</b>					
TCB-T	X	X	X	X	
TC-SC-2T	X	X	X	X	X
TC-AC-2T	X	X	X	X	X
<b>Communications Workstations</b>					
TC-7536-4TN	X	X	X	X	
TC-7556CT	X	X	X	X	

NOTE: All orders for add-ons and upgrade equipment MUST include the work order numbers and serial numbers of the system components involved.



TEMPEST OFFICE INFORMATION SYSTEMS  
ENTITLED SUPPORT SERVICES SUMMARY

Check Here if Acquired	Support Description	Activity Codes	Support Hours Up to -	Site Loc. Wang/Cust	Class Training Up to -	# of Class Attendees at No Charge**
	<u>7505T/7515T</u>					
	Pre-Installation Seminar	ET02	2 hrs.	X or X*		
	Pre-Installation Meeting	EP01	2 hrs.	X		
	Basic Word Processing Training	ET03		X	16 hrs.	1K
	System Administration Course	ET01		X	24 hrs.	1K
	Install Consultation	ET01	3 hrs.	X		
	Glossary Training	ET09		X	4 hrs.	1K
	Mathpak Training	ET05		X	4 hrs.	1K
	Technical Consultation	EC01	8 hrs.	X		
	<u>7535T/7540T</u>					
	Pre-Installation Seminar	ET02	2 hrs.	X or X*		
	Pre-Installation Meeting	EP01	2 hrs.	X		
	Basic Word Processing Training	ET03		X	16 hrs.	1K & 1A***
	System Administration Course	ET01		X	24 hrs.	1K & 1A
	Install Consultation	ET01	3 hrs.	X		
	Glossary Training	ET09		X	4 hrs.	1K
	Mathpak Training	ET05		X	4 hrs.	1K
	Technical Consultation	EC01	16 hrs.	X		

WANG

COMPANY CONFIDENTIAL

ENTITLED SUPPORT SERVICES DOCUMENTATION: Wang will provide one complete set of user reference and/or training documentation per system.

The support service here is Entitled Support to be delivered within 90 days of installation in accordance with Wang Policy and is provided at no additional charge with the equipment procurement. If support services not specified here are requested, the service may be provided in accordance with Wang Policies and at Wang's per call rates and terms then in effect.

\* Location of the pre-install seminar will be determined by Wang in order to best utilize Wang and customer resources.

\*\* K = Key Operator; A = System Administrator

\*\*\* The customer is entitled to Basic Word Processing training for one Key Operator for every ten workstations procured with the initial system order.

NOTE: All orders for add-ons and upgrade equipment MUST include the work order numbers and serial numbers of the system components involved.

7500T  
SYSTEMS

TEMPEST ALLIANCE 250  
ENTITLED SUPPORT SERVICES SUMMARY

SUPPORT DESCRIPTION	Activity Codes	Support Hours Up to -	Site Loc. Wang/Cust	Class Training Up to -	# of Class Attendees at No. Charged**
<b>7550T</b>					
<u>Pre-Installation</u>					
Pre-Installation Seminar	ET02	3 hrs.	X or X*	_____	N Contacts
Pre-Installation Meeting	EP01	12 hrs.	_____ X	_____	_____
Basic Word Processing Training	ET01	_____	X	16 hrs.	1K & 1A ***
System Administration Course	ET01	_____	X	24 hrs.	1K & 1A
<u>Installation</u>					
Consultation	ET01	5 hrs.	_____ X	_____	_____
<u>Post Installation</u>					
Glossary Training	ET02	_____	X	4 hrs.	1K
Mathpak Training	ET05	_____	X	4 hrs.	1K
Technical Consultation	EC01	8 hrs.	_____ X	_____	_____

WANG  
COMPANY CONFIDENTIAL

ENTITLED SUPPORT SERVICES DOCUMENTATION: Wang will provide one complete set of user reference and/or training documentation per system.

The support service here is Entitled Support to be delivered within 90 days of installation in accordance with Wang Policy and is provided at no additional charge with the equipment procurement. If support services not specified here are requested, the service may be provided in accordance with Wang Policies and at Wang's per call rates and terms then in effect.

\* Location of the pre-install seminar will be determined by Wang in order to best utilize Wang and customer resources.

\*\* K = Key Operator; A = System Administrator

\*\*\* The customer is entitled to Basic Word Processing training for one Key Operator for every ten workstations procured with the initial system order.

NOTE: All orders for add-ons and upgrade equipment MUST include the work order numbers and serial numbers of the system components involved.



TEMPEST WPS AND OIS UPGRADE/EXCHANGE  
ENTITLED SUPPORT SERVICES SUMMARY

Check Here If Acquired	Support Description	Activity Codes	Support Hours Up to -	Site Loc. Wang/Cust	Class Training Up to -	# of Class Attendees at No Charge**
—	<u>7520T, 7525T, 7530T to 7505T, 7515T</u>					
	Pre-Installation Seminar	ET02	2 hrs.	X or X*	_____	_____
	Pre-Installation Meeting	EP01	2 hrs.	X	_____	_____
	System Administration Course	ET01	_____	X	24 hrs.	1A
	Install Consultation	ET01	3 hrs.	X	_____	_____
	Glossary Training	ET09	_____	X	4 hrs.	1K
	Mathpak Training	ET05	_____	X	4 hrs.	1K
	Technical Consultation	EC01	4 hrs.	X	_____	_____
—	<u>7520T, 7525T, 7530T to 7535T, 7540T</u>					
	Pre-Installation Seminar	ET02	2 hrs.	X or X*	_____	_____
	Pre-Installation Meeting	EP01	2 hrs.	X	_____	_____
	System Administration Course	ET01	_____	X	24 hrs.	1K & 1A
	Install Consultation	ET01	3 hrs.	X	_____	_____
	Glossary Training	ET09	_____	X	4 hrs.	1K
	Mathpak Training	ET05	_____	X	4 hrs.	1K
	Technical Consultation	EC01	8 hrs.	X	_____	_____

WANG  
COMPANY CONFIDENTIAL

ENTITLED SUPPORT SERVICES DOCUMENTATION: Wang will provide one complete set of user reference and/or training documentation per system.

The support service here is Entitled Support to be delivered within 90 days of installation in accordance with Wang Policy and is provided at no additional charge with the equipment procurement. If support services not specified here are requested, the service may be provided in accordance with Wang Policies and at Wang's per call rates and terms then in effect.

\* Location of the pre-install seminar will be determined by Wang in order to best utilize Wang and customer resources.

\*\* K = Key Operator; A = System Administrator

\*\*\* The customer is entitled to Basic Word Processing training for one Key Operator for every ten workstations procured with the initial system order.

NOTE: All orders for add-ons and upgrade equipment MUST include the work order numbers and serial numbers of the system components involved.

7500T  
SYSTEMS

TEMPEST OIS AND ALLIANCE UPGRADE/EXCHANGE  
ENTITLED SUPPORT SERVICES SUMMARY

Check Here If Acquired	Support Description	Activity Codes	Support Hours Up to	Site Loc. Wang/Cust	Class Training Up to	# of Class Attendees at No Charge**
—	<u>7505T, 7515T to 7535T, 7540T</u>					
	Pre-Installation Meeting	EP01	2 hrs.	X or X*		
	Basic Word Processing Training	ET01		X	16 hrs.	1A ***
	System Administration Course	ET01		X	24 hrs.	1A
	Install Consultation	ET01	3 hrs.	X		
	Technical Consultation	EC01	8 hrs.	X		
—	<u>7505T, 7515T, 7535T, 7540T to 7550T</u>					
	Pre-Installation Seminar	ET02	3 hrs.	X or X*		
	Pre-Installation Meeting	EP01	6 hrs.	X		
	System Administration Course	ET01		X	24 hrs.	1K & 1A
	Install Consultation	ET01	3 hrs.	X		
	Technical Consultation	EC01	16 hrs.	X		

ENTITLED SUPPORT SERVICES DOCUMENTATION: Wang will provide one complete set of user reference and/or training documentation per system.

The support service here is Entitled Support to be delivered within 90 days of installation in accordance with Wang Policy and is provided at no additional charge with the equipment procurement. If support services not specified here are requested, the service may be provided in accordance with Wang Policies and at Wang's per call rates and terms then in effect.

\* Location of the pre-install seminar will be determined by Wang in order to best utilize Wang and customer resources.

\*\* K = Key Operator; A = System Administrator

\*\*\* The customer is entitled to Basic Word Processing training for one Key Operator for every ten workstations procured with the initial system order.

NOTE: All orders for add-ons and upgrade equipment MUST include the work order numbers and serial numbers of the system components involved.

WANG

COMPANY CONFIDENTIAL

COMPANY CONFIDENTIAL

Effective Date: May 1, 1984

-Prices and equipment availability subject to change without notice-

WANGNET PRODUCT LINE PRICE LIST

<u>DESCRIPTION</u>	<u>PAGE</u>	<u>EFFECTIVE DATE</u>
Site Survey, Design and Certification-	2	05/01/84
Cable Interface Unit (Wang Band)	2	05/01/84
Workstation Attachment (Peripheral Band)	2	05/01/84
Interconnect Band Devices	2	05/01/84
Cable Kits	3	05/01/84
FastLAN	4	05/01/84
Entitled Summaries	5	05/01/84
OIS and Alliance Masters with WangNet Interface (Peripheral Band)		See WP/OIS page 12
Upgrades of OIS and Alliance Masters with WangNet Interface		See WP/OIS page 46
VS IOP with WangNet Interface (Peripheral Band)		See VS/ page 13
Ergonomic Workstations with WangNet Interface (Peripheral Band)		See Ergo 2 and S300 listings in the WP/OIS page 18 and VS sections page 45

NOTE: All orders for add-ons and upgrade equipment MUST include the work order numbers and serial numbers of the system components involved.

WN/ 7 - 1

COMPANY CONFIDENTIAL  
REPLACES: 02/01/84  
EFFECTIVE: 05/01/84



WANG

COMPANY CONFIDENTIAL



MODEL NUMBER	DESCRIPTION	PURCHASE PRICE	MONTHLY MAINTENANCE	-----MONTHLY RENTAL PRICES-----			
				1 YEAR	2 YEAR	3 YEAR	5 YEAR
<b>SITE SURVEY, DESIGN AND CERTIFICATION</b>							
WSS	WangNet Site Survey	\$ 1,800	N/A	N/A	N/A	N/A	N/A
WSSADD	WangNet Site Survey for additional building when performed in conjunction with Primary Site Survey	650	N/A	N/A	N/A	N/A	N/A

NOTE: The purchase price for model's WSS and WSSAD is not discountable.

The customer is charged on the basis of labor hours for the particular WangNet Site for the following:

WDI	WangNet Cable Design	N/A	N/A	N/A	N/A	N/A	N/A
WNC	WangNet Cable Certification	N/A	N/A	N/A	N/A	N/A	N/A

**CABLE INTERFACE UNIT (Wang Band)**

CIU-A	OIS/Alliance cable interface unit	\$ 3,800	\$ 41	\$ 247	\$ 209	\$ 168	\$ 152
CIU-B	VS Cable Interface Unit	3,800	41	247	209	168	152
CIU-C	Alliance Cable Interface Unit	3,800	41	247	209	168	152

**WORKSTATION ATTACHMENT (Peripheral Band)**

NETMUX	8 port multiplexer for attaching workstations, printers and serial devices to WangNet.	\$ 1,600	\$ 10	\$ 104	\$ 88	\$ 71	\$ 64
--------	--	----------	-------	--------	-------	-------	-------

NOTE: Ergo workstations with WangNet Interface connect directly to WangNet. See Ergo 2 and 5300 listings in the WP/OIS and VS sections.

**INTERCONNECT BAND DEVICES**

FFM9600	Fixed Frequency Modem. Supports transmission rates of up to 9600BPS.	\$ 850	\$ 9	\$ 56	\$ 47	\$ 38	\$ 34
FFM64000	Fixed Frequency Modem. Supports transmission rates of up to 64KB.	1,200	14	78	66	53	48
PFG912	9.12 MHZ Pilot Frequency Generator. Required for WangNet Cable Kits with attached FFM9600s.	775	5	51	43	35	31
PFG48	Required for use of FFM64000 except those cables or Cable Kits with Data Switches.	800	5	52	44	36	32

NOTE: All orders for add-ons and upgrade equipment MUST include the work order numbers and serial numbers of the system components involved.



MODEL NUMBER	DESCRIPTION	PURCHASE PRICE	MONTHLY MAINTENANCE	-----MONTHLY RENTAL PRICES-----			
				1 YEAR	2 YEAR	3 YEAR	5 YEAR
INTERCONNECT BAND DEVICES (continued)							
FAH9600	Frequency Agile Modem. Supports transmission rates of up to 9600BPS.	\$ 1,280	\$ 14	\$ 82	\$ 69	\$ 55	\$ 50
DS256	DataSwitch (Controls 256 Circuits)	12,000	130	780	660	528	480
CABLE KITS							
PVC							
WNKIT4-H	WangNet Cable Kit; Mini-head-end, 4 60' drop cable assemblies	\$ 1,350	\$ 15	N/A	N/A	N/A	N/A
WNKIT12-70	WangNet Cable Kit; Mini-head-end, 2 4-port tap assemblies, 70' cables between components, 12 60' drop cable assemblies	3,350	20	N/A	N/A	N/A	N/A
WNKIT20-35	WangNet Cable Kit; Mini-head-end, 4 4-port tap assemblies, 35' cables between components, 20 60' drop cable assemblies	4,150	25	N/A	N/A	N/A	N/A
TEFLON							
WNKIT4-HT	WangNet Cable Kit; Mini-head-end, 4 60' drop cable assemblies	\$ 2,400	\$ 15	N/A	N/A	N/A	N/A
WNKIT12-70T	WangNet Cable Kit; Mini-head-end, 2 4-port tap assemblies, 70' cables between components, 12 60' drop cable assemblies	7,050	20	N/A	N/A	N/A	N/A
WNKIT20-35T	WangNet Cable Kit; Mini-head-end, 4 4-port tap assemblies, 35' cables between components, 20 60' drop cable assemblies	10,000	25	N/A	N/A	N/A	N/A
120-2307	25 FT WANGNET INTER CABLE	15	N/A	N/A	N/A	N/A	N/A
220-0294	10 FT WANGNET UNTER CABLE	10	N/A	N/A	N/A	N/A	N/A

NOTE: All orders for add-ons and upgrade equipment MUST include the work order numbers and serial numbers of the system components involved.

MODEL  
NUMBER

DESCRIPTION

PURCHASE  
PRICE

MONTHLY  
MAINTENANCE

-----MONTHLY RENTAL PRICES-----  
1 YEAR 2 YEAR 3 YEAR 5 YEAR

CABLE MULTIPLEXER

NOTE: One CIU is required to operate TCHS WangBand Software. One dedicated VS 45 System (VS Packaged System VS45G) is required as the Base System of WangNet TCHS.

CMUX-3270	IBM 3270 Cable Multiplexer (8 port base unit)	\$ 3,375	\$ 33	\$ 220	\$ 186	\$ 149	\$ 135
CMUX-3270/DSM	8 Port Device Support Module for CMUX-3270 Port Expansion	375	4	25	21	17	16
WSNH-TCHS-1	WangNet Tech Control & Manage- ment System Option 1 WangBand Software	7,500	N/A	N/A	N/A	N/A	N/A
FASTLAN							
FASTLAN-A	FASTLAN Amplifier Unit-PVC	\$ 995	\$ 20	N/A	N/A	N/A	N/A
FASTLAN-B	FASTLAN Network Branch-PVC	350	6	N/A	N/A	N/A	N/A
FASTLAN-C	FASTLAN Drop/MUO Assembly - PVC	120	N/A*	N/A	N/A	N/A	N/A
FASTLAN-AT	FASTLAN Amplifier Unit-Teflon	1,300	20	N/A	N/A	N/A	N/A
FASTLAN-BT	FASTLAN Network Branch - Teflon	800	6	N/A	N/A	N/A	N/A
FASTLAN-CT	FASTLAN Drop/MUO Assembly - Teflon	180	N/A*	N/A	N/A	N/A	N/A
FASTLAN-EMC	Optional Amplifier Office Enclosure	640	N/A	N/A	N/A	N/A	N/A

\* The Maintenance charge for the Network Branch ("B") includes support for all Drop/MUO Assembly ("C") components connected to the Network Branch.

For customers purchasing FastLAN products who request a Maintenance Contract after the product warranty has expired, a pre-contract verification fee will be charged to insure functionality of the network. This charge will be \$50 for each Network Branch component with a minimum call charge of \$200.

NOTE: All orders for add-ons and upgrade equipment MUST include the work order numbers and serial numbers of the system components involved.

WM/ 7 - 4

COMPANY CONFIDENTIAL  
REPLACES: 02/01/84  
EFFECTIVE: 05/01/84

WANGNET

WANGNET  
ENTITLED SUPPORT SERVICES SUMMARY

Check Here if Acquired	SUPPORT DESCRIPTION	Activity Codes	Support Hours Up to	Site Loc. Wang/Cust
	<u>Pre-Installation Consultation</u>			
	Network Management	EP02	4 hrs.	___ X
	Peripheral Band	EP01		___ X
	--Coaxial Cable Substitution"		1 hr.	___ X
	Interconnect Band"	EP03		___ X
	--Dedicated Line Services		1 hr.	___ X
	--Remote WangNet Integration		1 hr.	___ X
	--Switched Line Services		4 hrs.	___ X
	WangBand"	EP04		___ X
	--Peripheral Sharing		2 hrs.	___ X
	--Security/Access for OIS, CIU-A***		2 hrs.	___ X
	VS, CIU-B***		2 hrs.	___ X
	--Virtual Terminal Capabilities		4 hrs.	___ X
	--File Transfer Capabilities		2 hrs.	___ X
	Utility Band"	EP05	1 hr.	___ X
	<u>Post-Installation Consultation</u>			
	Interconnect Band"	EC05		___ X
	--Data-Switch Operations Test		1 hr.	___ X
	WangBand"	EC06		___ X
	--File Transfer Operations Test		4 hrs.	___ X
	General Network	EC07	6 hrs.	___ X

WANGNET  
COMPANY CONFIDENTIAL

Entitlement for WangNet is currently under evaluation to determine if any changes are necessary to adequately represent Wang's commitment to networking.

ENTITLED SUPPORT SERVICES DOCUMENTATION: Wang will provide one complete set of pre-installation materials and one complete set of orientation and implementation materials.

The support service specified here is Entitled Support to be delivered within 90 days of installation in accordance with Wang Policy and is provided at no additional charge with the equipment procurement. If support services not specified here are requested, the service may be provided in accordance with Wang Policies and at Wang's per call rates and terms then in effect.

\* When WangNet is installed as a coaxial cable substitution, this is the only applicable support.

\*\* Provided free of charge if these functions are utilized.

\*\*\* Provided free of charge for each type of attached Wang system.

NOTE: All orders for add-ons and upgrade equipment MUST include the work order numbers and serial numbers of the system components involved.



COMPANY CONFIDENTIAL

Effective Date: MAY 1, 1984

Prices and equipment availability subject to change without notice-

WANG WA3451 MODEM PRODUCT LINE PRICE LIST

MODEL NUMBER	DESCRIPTION	PURCHASE PRICE	MONTHLY MAINTENANCE
WA3451	300/1200 bps Synchronous/ Asynchronous Modem	\$ 1,050	\$ 12

If ordered for use with 2200 terminals, a TC cable is required for each modem (e.g. 12' RS-232 TC cable, part number 220-0113, see supplies catalog)

NOTE: All orders for add-ons and upgrade equipment MUST include the work order numbers and serial numbers of the system components involved.

WM/ 8 - 1

COMPANY CONFIDENTIAL  
REPLACES: 02/01/84  
EFFECTIVE: 05/01/84



WANG

COMPANY CONFIDENTIAL



COMPANY CONFIDENTIAL

Effective Date: MAY 1, 1984

-Prices and equipment availability subject to change without notice-

DIGITAL VOICE EXCHANGE  
PRODUCT LINE PRICE LIST

TABLE OF CONTENTS

<u>DESCRIPTION</u>	<u>PAGE</u>	<u>EFFECTIVE DATE</u>
DVX	2	05/01/84
SOFTWARE	2	05/01/84
UPGRADES	2	05/01/84
GENERAL INFORMATION	3	05/01/84
DVX CONTRACT CONVERSION SUMMARY	4	05/01/84
DVX CONFIGURATION	5	05/01/84
VCA CONFIGURATION	5	05/01/84
ENTITLEMENT SUMMARY	7	05/01/84

WADC

COMPANY CONFIDENTIAL

NOTE: All orders for add-ons and upgrade equipment MUST include the work order numbers and serial numbers of the system components involved.

WANG

COMPANY CONFIDENTIAL



MODEL NUMBER	DESCRIPTION	PURCHASE PRICE	MONTHLY MAINTENANCE	-----MONTHLY RENTAL PRICES-----			
				1 YEAR	2 YEAR	3 YEAR	5 YEAR
<u>DVX MESSAGING WAITING LIGHT</u>							
DVX-MMU	DVX Messaging Waiting Light						
	Quantities of 1 to 24	\$ 225	N/A	\$ 16	\$ 12	\$ 10	9
	Quantities of 25 to 499	195	N/A	N/A	N/A	N/A	N/A
	Quantities of 500 to 999	185	N/A	N/A	N/A	N/A	N/A
	Quantities of 1000 and up	175	N/A	N/A	N/A	N/A	N/A

<u>DVX HARDWARE</u>							
DVXC-4	DVX IQMP cabinet with 4 Ports	\$ 22,000	\$ 86	\$ 1,540	\$ 1,100	\$ 968	880
DVXC-8	DVX IQMP cabinet with 8 Ports	42,000	172	2,940	2,100	1,848	1,680
DVXC-12	DVX IQMP cabinet with 12 Ports	62,000	258	4,340	3,100	2,728	2,480
DVXC-16	DVX IQMP cabinet with 16 Ports	82,000	344	5,740	4,100	3,608	3,280

MODEL NUMBER	DESCRIPTION	INITIAL LICENSE FEE	MONTHLY LICENSE FEE	-----MONTHLY RENTAL PRICES-----			
				1 YEAR	2 YEAR	3 YEAR	5 YEAR
<u>DVX SOFTWARE</u>							
DVXFP	Voice messaging application and operation system	\$ 14,000	\$ 140	\$ 980	\$ 700	\$ 616	560
DVX-NET	DVX networking software	1,000	10	70	50	44	40
DVX-VCA	4-IQMP Module with Power Supply	N/A	N/A	N/A	N/A	N/A	N/A
VCASHELF	VCA Card Cage	N/A	N/A	N/A	N/A	N/A	N/A

NOTE: See configuration chart for information on how to order VCAs.

UPGRADE JOB #	DESCRIPTION	PURCHASE PRICE	-----R E N T A L-----	
			SINGLE OR MONTHLY CHARGE	1 YEAR

The purchase/rental charges listed include any applicable difference in prices. For purchase systems the incremental maintenance charge is also due.

<u>DVX UPGRADES</u>				
UJ-1105	DVX Upgrade 4 Port Add-On	\$ 20,000	\$ 1,000	\$ 100
UJ-1286	DVX IQMP Cabinet Only	2,000	N/A	N/A

NOTE: All orders for add-ons and upgrade equipment MUST include the work order numbers and serial numbers of the system components involved.



## GENERAL INFORMATION

1. The sales representative must submit the appropriate upgrade job number whenever upgrading a system. This is a unique upgrade job number for each "upgrade".
2. All upgrade job numbers have been listed in this price list.
3. Submission of "upgrades" must be accompanied by a description of the DVX hardware already in place. This information should include the existing configuration and should make reference to the work order numbers on which the equipment was originally ordered.
4. "Upgrade" charges apply to both purchased and rented equipment.
5. A customer who has purchased hardware pays the amount listed under the column "Purchase Single Charge." This includes both the "upgrade" charge and the price of the items. Maintenance on the upgraded unit is also due.
6. A customer with rented hardware may opt to pay either the "Rental Single Charge" or the "Rental Monthly" payments for one (1) year. In either case, the incremental difference in the monthly rental rates between the old and upgraded system configuration is also due.
7. The rental of upgraded equipment will be coterminous with the initial DVX installation.
8. Trial converted to third party lease treated as purchase for lease accruals credit.
9. For additional cable length between the DVX CPU and the workstation and the printer, order the appropriate length cable(s) (Part Number 120-2300-X).
10. Stand for Matrix printer not included. To order, see Supplies Catalog.
11. See page 9 - 5 for information on configuring VCA equipment for installation.

NOTE: All orders for add-ons and upgrade equipment MUST include the work order numbers and serial numbers of the system components involved.

**DVX CONTRACT CONVERSION SUMMARY**

TYPE	INITIAL	CONVERT TO PURCHASE	CONVERT TO LONG TERM RENTAL	CANCEL
PURCHASE	- Hardware Price - Software License Fee - Monthly Maint. for first 12 months	N/A	N/A	N/A
TRIAL	- 7% per month of hardware price & Software License fee. - 3 month minimum - 30 day notice for cancellation	- within 90 days: 90% of accrued rental applied to purchase price. Between 91 and 360 days: 50% applied.	- old rate stops new rate begins (no accruals applied towards new rates) - 3rd party lease	- 3 month minimum rental period. - 30 day minimum end of trial notification or cancellation charge of 1 month
LONG TERM RENTAL	- 2 thru 5 year lease available (see applicable schedules)	- within 90 days: 90% of accrued rental applied to purchase price. Between 91 and 360 days: 50% applied.	- old rate stops new rate begins (no accruals applied towards new rates)	- Premature contract cancellation charge

CONFIDENTIAL  
 COMPANY CONFIDENTIAL  
 11/11/84

NOTE: All orders for add-ons and upgrade equipment MUST include the work order numbers and serial numbers of the system components involved.





DVX CONFIGURATION

DVX hardware pricing has been unbundled. The diagram below illustrates the components needed for a basic DVX system. This diagram should be used as a guideline when ordering the various DVX system components.

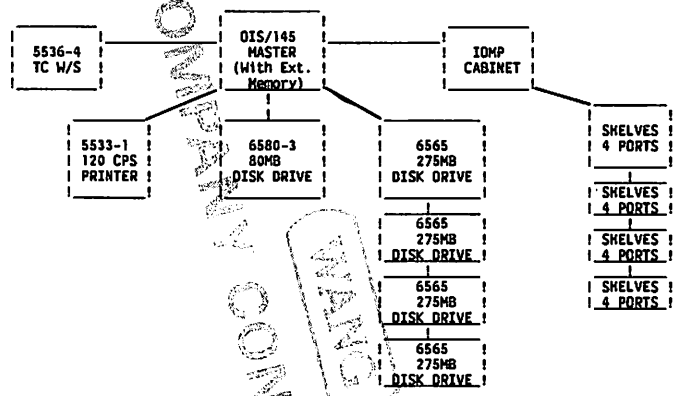

VCA CONFIGURATOR

New Installations

<u>Total DVX Ports except those arranged with tie lines.</u>	<u>DVX-VCA Required</u>	<u>DVX-VCASHELF Required</u>
1, 2, 3, or 4	1	1
5, 6, 7, or 8	2	1
9, 10, 11, or 12	3	2
13, 14, 15, or 16	4	2

Upgrade Installations

Determine overall requirements from chart above and subtract existing DVX-VCA and DVX-VCASHELF hardware.

NOTE: All orders for add-ons and upgrade equipment MUST include the work order numbers and serial numbers of the system components involved.



DVX CONFIGURATION

DVX is an OIS-based system. OIS hardware used in the configuration of a DVX system is listed below:

MODEL NUMBER	DESCRIPTION	PURCHASE PRICE	MONTHLY MAINTENANCE	-----MONTHLY RENTAL PRICES-----			
				1 YEAR	2 YEAR	3 YEAR	5 YEAR
6545A	OIS 145A Master, 275 MB Disk, and Single Diskette	\$ 38,000	\$ 388	\$ 2,090	\$ 1,938	\$ 1,672	\$ 1,520
EM-OIS	Extended memory option for OIS 100's only (additional 64K) Required for all External File Source (XFS) products, i.e. WISE,3271,Remote MangMet, etc.	2,000	25	102	96	88	81
TC-5536-4	64K CRT/keyboard workstation	5,000	47	301	219	209	190
6565	Optional 275 MB Disk Drive for OIS 140-1,2,3/145A/Alliance	18,000	255	990	918	792	720
6580-3	Optional 80.4 MB Disk Drive for OIS 140-1,2,3/145A/Alliance	13,000	186	715	663	572	520
5533-1	120 CPS Bidirectional Matrix Printer. 12.2 Pitch ONLY, 158 Columns OIS ONLY	3,500	46	165	161	154	140
MODEL NUMBER	DESCRIPTION	INITIAL LICENSE FEE	MONTHLY LICENSE FEE	-----MONTHLY RENTAL PRICES-----			
				1 YEAR	2 YEAR	3 YEAR	5 YEAR
OIS-BASIC-9	Office BASIC Compiler (195-2518-9)	\$ 1,500	\$ 5	\$ 81	\$ 75	\$ 65	\$ 60

FOOTNOTES

- (1) Extended Memory required for all DVX Systems.
- (2) One 275 MB disk drive is included with the OIS Master. Up to three additional 275 MB disk drives (or a total of four 275 MB disk drives) may be installed for a single DVX system.
- (3) Other OIS printers may be substituted.
- (4) WP software is provided with the OIS Master and may be used concurrently with the DVX application.

NOTE: All orders for add-ons and upgrade equipment MUST include the work order numbers and serial numbers of the system components involved.

DVX™  
DIGITAL VOICE EXCHANGE  
ENTITLED SUPPORT SERVICES SUMMARY

<u>SUPPORT DESCRIPTION</u>	<u>Activity Codes</u>	<u>Support Hours Up to-</u>	<u>Site Loc. Wang/Cust</u>	<u>Class Training Up to-</u>	<u># of Class Attendees at No Charge</u>
<b>Pre-Installation</b>					
--Pre-Installation Meeting	<u>EP01</u>	<u>2 hrs.</u>	<u>   </u> <u>X</u>	<u>   </u>	<u>   </u>
--System Administration Course	<u>ET01</u>	<u>   </u>	<u>X</u> <u>   </u>	<u>24 hrs.</u>	<u>2 Contacts</u>
<b>Installation</b>					
--Consultation	<u>EI 01</u>	<u>6 hrs.</u>	<u>   </u> <u>X</u>	<u>   </u>	<u>   </u>
<b>Post-Installation</b>					
--Customer Training Seminar	<u>ET05</u>	<u>   </u>	<u>   </u> <u>X</u>	<u>8 hrs.</u>	<u>20 Trainers</u>
--Post-training follow-up	<u>EC02</u>	<u>2 hrs.</u>	<u>   </u> <u>X</u>	<u>   </u>	<u>   </u>
--Technical Consultation	<u>EC01</u>	<u>14 hrs.</u>	<u>   </u> <u>X</u>	<u>   </u>	<u>   </u>

WANG

COMPANY CONFIDENTIAL

ENTITLED SUPPORT SERVICES DOCUMENTATION: Wang will provide one complete set of user reference documentation per system.

The support service specified here is Entitled Support to be delivered within 90 days of installation in accordance with Wang Policy and is provided at no additional charge with the equipment procurement. If support services not specified here are requested, the service may be provided in accordance with Wang Policies and at Wang's per call rates and terms then in effect.

NOTE: All orders for add-ons and upgrade equipment MUST include the work order numbers and serial numbers of the system components involved.

COMPANY CONFIDENTIAL

Effective Date: MAY 1, 1984

-Prices and equipment availability subject to change without notice-

PROFESSIONAL COMPUTER PRODUCT LINE PRICE LIST

TABLE OF CONTENTS

<u>DESCRIPTION</u>	<u>PAGE</u>	<u>EFFECTIVE DATE</u>
PC MODELS		
PCPK1	2	05/01/84
PC001	2	05/01/84
PC002	2	05/01/84
PC003B	2	05/01/84
PC004A	3	05/01/84
PC005A	3	05/01/84
PC006	4	05/01/84
EXPANDED CHASSIS	4	05/01/84
OPTIONS PERIPHERAL MODULES	5	05/01/84
PRINTER OPTIONS	8	05/01/84
ACCESSORIES	10	05/01/84
APPLICATION SOFTWARE	11	05/01/84
SYSTEM SOFTWARE	12	05/01/84
UPGRADES	16	05/01/84
WANG PROFESSIONAL COMPUTER TERMS AND CONDITIONS	17	05/01/84

WANG  
COMPANY CONFIDENTIAL

MAIL-IN WARRANTY

For customers who choose not to purchase a maintenance agreement at the time of sale the 90 day parts and labor warranty repair for the Professional Computer is accomplished by the customer mailing the failed module to the nearest Wang Field Support Center (Located in Lawrence, Massachusetts; Atlanta, Georgia; or Culver City, California). Customers can arrange for warranty repair by calling the PC Assistance Center toll-free number.

MAINTENANCE AGREEMENT On-Site (Plan A)

Wang's Standard On-Site Maintenance Agreement, for which prices are specified herein, provides for 12 months of on-site service. For customers who elect to purchase an On-Site Maintenance Agreement at the time of sale, Wang will provide on-site warranty service for 90 days, followed by the 12 month On-Site Maintenance Agreement.

INSTALLATION CHARGE

The Professional Computer is a customer installable machine. Detailed installation instructions are included with each unit. The customer is responsible for unpacking system components, attaching them correctly, and running the diagnostic program. Installation services from Wang Laboratories, Inc. is available for a fee of \$200 per Professional Computer system, plus any distance surcharges that may be applicable. During the initial installation of a VS or OIS, when Wang PC's are being connected as workstations, Wang will install each PC. In this case, the \$200/unit installation fee is waived.



WANG

COMPANY CONFIDENTIAL



MODEL  
NUMBER

DESCRIPTION

PURCHASE  
PRICEMONTHLY  
MAINTENANCE---MONTHLY RENTAL PRICES---  
1 YEAR 2 YEAR 3 YEAR 5 YEAR

PC QUANTITY	DISCOUNT	PLAN A	PLAN C	PLAN M					
		ON-SITE	CARRY-IN	MAIL-IN					
QTY	1-19	SCHEDULE (APPLIES WHERE LISTED)							
	20-49	0%							
	50-149	12%							
	150-249	16%							
		20%							

PROFESSIONAL MODELS

PC-PK1	Professional Decision Support System Package Includes: PC-004A Base Unit, 128KB Expansion Card, Advanced MP, Multiplan, Asynchronous Communications, Database, Business Graphics								
	Quantities of 1 to 19	\$ 5,995	\$ 37	\$ 26	\$ 19	\$ 390	\$ 330	288	N/A
	Quantities of 20 to 49	5,280	37	26	19	390	330	288	N/A
	Quantities of 50 to 149	5,040	37	26	19	390	330	288	N/A
	Quantities of 150 to 249	4,800	37	26	19	390	330	288	N/A
PC-001	Base Unit (128KB), with Diskette Drive (360KB), Keyboard, MS/DOS Operating Systems and Interpretive BASIC								
	Quantities of 1 to 19	2,595	15	10	9	169	143	125	N/A
	Quantities of 20 to 49	2,285	15	10	9	169	143	125	N/A
	Quantities of 50 to 149	2,180	15	10	9	169	143	125	N/A
	Quantities of 150 to 249	2,080	15	10	9	169	143	125	N/A
PC-002	PC W/Single Diskette Wang Monitor Includes PC-001 Plus: PC-PM001 Wang Monochrome Monitor Card (Character Only) PC-PM004 Wang Monochrome Monitor								
	Quantities of 1 to 19	3,265	21	14	12	213	180	157	N/A
	Quantities of 20 to 49	2,875	21	14	12	213	180	157	N/A
	Quantities of 50 to 149	2,745	21	14	12	213	180	157	N/A
	Quantities of 150 to 249	2,615	21	14	12	213	180	157	N/A
PC-003B	PC W/Dual Floppy Includes PC-001 plus: PC-PM001 Wang Monochrome Monitor Card (Character Only) PC-PM004 Wang Monochrome Monitor PC-PM020 Diskette Drive (5 1/4" 360KB)								
	Quantities of 1 to 19	3,790	29	20	17	247	209	182	N/A
	Quantities of 20 to 49	3,340	29	20	17	247	209	182	N/A
	Quantities of 50 to 149	3,185	29	20	17	247	209	182	N/A
	Quantities of 150 to 249	3,035	29	20	17	247	209	182	N/A

NOTE: All orders for add-ons and upgrade equipment MUST include the work order numbers and serial numbers of the system components involved.



MODEL NUMBER	DESCRIPTION	PURCHASE PRICE	MONTHLY MAINTENANCE			---MONTHLY RENTAL PRICES---				
			PLAN A ON-SITE	PLAN C CARRY-IN	PLAN H MAIL-IN	1 YEAR	2 YEAR	3 YEAR	5 YEAR	
<u>PROFESSIONAL MODELS (continued)</u>										
PC-004A	PC W/Dual Floppy Includes PC-001 plus:									
	PC-PH001 Wang Monochrome Monitor Card (Character Only)									
	PC-PH002 Wang Graphics Card									
	PC-PH004 Wang Monochrome Monitor									
	PC-PH020 Diskette Drive (5 1/4" 360KB)									
	Quantities of 1 to 19	\$ 4,090	\$ 32	\$ 22	\$ 19	\$ 266	\$ 225	197	N/A	
	Quantities of 20 to 49	3,600	32	22	19	266	225	197	N/A	
	Quantities of 50 to 149	3,440	32	22	19	266	225	197	N/A	
	Quantities of 150 to 249	3,275	32	22	19	266	225	197	N/A	
PC-005A	PC W/10MB Winchester Disk, includes PC-001 Plus:									
	PC-PH001 Wang Monochrome Monitor Card (Character Only)									
	PC-PH002 Wang Graphics Card									
	PC-PH004 Wang Monochrome Monitor									
	PC-PH030 Memory Expansion Card with Parity (128KB)									
	PC-PH021 Winchester Drive (5 1/4" 10MB) includes Winchester Controller Card									
	Quantities of 1 to 19	6,460	53	36	31	420	356	311	N/A	
	Quantities of 20 to 49	5,685	53	36	31	420	356	311	N/A	
	Quantities of 50 to 149	5,430	53	36	31	420	356	311	N/A	
	Quantities of 150 to 249	5,170	53	36	31	420	356	311	N/A	

PROFESSIONAL MODELS (continued)

COMPANY CONFIDENTIAL  
 WANG

NOTE: All orders for add-ons and upgrade equipment MUST include the work order numbers and serial numbers of the system components involved.

MODEL  
NUMBER

DESCRIPTION

PURCHASE  
PRICEMONTHLY  
MAINTENANCE  
PLAN A  
ON-SITE    PLAN C  
CARRY-IN    PLAN M  
MAIL-IN---MONTHLY RENTAL PRICES---  
1 YEAR    2 YEAR    3 YEAR    5 YEAREXPANDED CHASSIS PC

NOTE: Monitor card and monitor must be ordered separately for all models listed below.

MODEL NUMBER	DESCRIPTION	PURCHASE PRICE	PLAN A ON-SITE	PLAN C CARRY-IN	PLAN M MAIL-IN	1 YEAR	2 YEAR	3 YEAR	5 YEAR
PC-XC	Expanded chassis Only Required to Upgrade from Standard Chassis	\$ 1,380	N/A	N/A	N/A	N/A	N/A	N/A	N/A
PC-XC1	Expanded Chassis Base Unit (128KB), with Single Diskette Drive (360KB), Keyboard, MS/DOS Operating System and Interpretive BASIC								
	Quantities of 1 to 19	2,945	18	N/A	N/A	192	162	142	N/A
	Quantities of 20 to 49	2,595	18	N/A	N/A	192	162	142	N/A
	Quantities of 50 to 149	2,475	18	N/A	N/A	192	162	142	N/A
	Quantities of 150 to 249	2,360	18	N/A	N/A	192	162	142	N/A
PC-XC2	Expanded Chassis Base Unit (128KB), with Dual Diskette Drives (360KB Each), Keyboard, MS/DOS Operating System and Interpretive BASIC								
	Quantities of 1 to 19	3,470	26	N/A	N/A	226	191	167	N/A
	Quantities of 20 to 49	3,055	26	N/A	N/A	226	191	167	N/A
	Quantities of 50 to 149	2,915	26	N/A	N/A	226	191	167	N/A
	Quantities of 150 to 249	2,780	26	N/A	N/A	226	191	167	N/A

NOTE: All orders for add-ons and upgrade equipment MUST include the work order numbers and serial numbers of the system components involved.

PC/ 10 - 4

COMPANY CONFIDENTIAL  
REPLACES: 02/01/84  
EFFECTIVE: 05/01/84

MODEL NUMBER	DESCRIPTION	PURCHASE PRICE	MONTHLY MAINTENANCE			---MONTHLY RENTAL PRICES---			
			PLAN A	PLAN C	PLAN H	1 YEAR	2 YEAR	3 YEAR	5 YEAR
			ON-SITE	CARRY-IN	MAIL-IN				

## EXPANDED CHASSIS PC (continued)

NOTE: Monitor card and monitor must be ordered separately for all models listed below.

PC-XC3	Expanded Chassis Base Unit with Single Diskette Drive (360KB) 10MB Winchester Drive, Winchester Controller Card, Keyboard, MS/DOS Operating System and Interpretive BASIC								
	Quantities of 1 to 19	\$ 5,330	\$ 42	N/A	N/A	\$ 347	\$ 294	\$ 256	N/A
	Quantities of 20 to 49	4,695	42	N/A	N/A	347	294	256	N/A
	Quantities of 50 to 149	4,480	42	N/A	N/A	347	294	256	N/A
	Quantities of 150 to 249	4,265	42	N/A	N/A	347	294	256	N/A

## OPTIONS/PERIPHERAL MODULES

PC-PH001	Wang Monochrome Monitor Card (Character Only)								
	Quantities of 1 to 19	\$ 330	\$ 2	\$ 1	\$ 22	\$ 19	\$ 16	N/A	
	Quantities of 20 to 49	295	2	1	22	19	16	N/A	
	Quantities of 50 to 149	280	2	1	22	19	16	N/A	
	Quantities of 150 to 249	265	2	1	22	19	16	N/A	
PC-PH002	Wang Graphics Card								
	Quantities of 1 to 19	300			2	20	17	15	N/A
	Quantities of 20 to 49	265			2	20	17	15	N/A
	Quantities of 50 to 149	255			2	20	17	15	N/A
	Quantities of 150 to 249	240			2	20	17	15	N/A
PC-PH003	Industry Standard Monitor Card								
	Quantities of 1 to 19	400	5	4	3	26	22	20	N/A
	Quantities of 20 to 49	355	5	4	3	26	22	20	N/A
	Quantities of 50 to 149	340	5	4	3	26	22	20	N/A
	Quantities of 150 to 249	320	5	4	3	26	22	20	N/A

NOTE: All orders for add-ons and upgrade equipment MUST include the work order numbers and serial numbers of the system components involved.

MODEL NUMBER	DESCRIPTION	PURCHASE PRICE	MONTHLY MAINTENANCE			---MONTHLY RENTAL PRICES---			
			PLAN A ON-SITE	PLAN C CARRY-IN	PLAN M MAIL-IN	1 YEAR	2 YEAR	3 YEAR	5 YEAR
<u>OPTIONS PERIPHERAL MODULES (continued)</u>									
PC-PH004	Wang Monochrome Monitor								
	Quantities of 1 to 19	\$ 340	\$ 4	\$ 3	\$ 2	\$ 23	\$ 19	17	N/A
	Quantities of 20 to 49	300	4	3	2	23	19	17	N/A
	Quantities of 50 to 149	290	4	3	2	23	19	17	N/A
	Quantities of 150 to 249	275	4	3	2	23	19	17	N/A
PC-PH010	(80 CPS) Wang Matrix Printer (Single Sheet Feeder With Graphics Output)								
	Quantities of 1 to 19	900	7	5	4	59	50	44	N/A
	Quantities of 20 to 49	795	7	5	4	59	50	44	N/A
	Quantities of 50 to 149	760	7	5	4	59	50	44	N/A
	Quantities of 150 to 249	720	7	5	4	59	50	44	N/A
PC-PH012	20 CPS Daisy Printer								
	Quantities of 1 to 19	1,295	25	15	N/A	85	72	63	N/A
	Quantities of 20 to 49	1,140	25	15	N/A	85	72	63	N/A
	Quantities of 50 to 149	1,090	25	15	N/A	85	72	63	N/A
	Quantities of 150 to 249	1,040	25	15	N/A	85	72	63	N/A
PC-PH014	55 CPS Daisy Printer								
	Quantities of 1 to 19	2,995	43	N/A	N/A	195	165	144	N/A
	Quantities of 20 to 49	2,640	43	N/A	N/A	195	165	144	N/A
	Quantities of 50 to 149	2,520	43	N/A	N/A	195	165	144	N/A
	Quantities of 150 to 249	2,400	43	N/A	N/A	195	165	144	N/A
PC-PH020	Diskette Drive (\$ 1/4" 360KB)								
	Quantities of 1 to 19	525	8	6	5	35	29	26	N/A
	Quantities of 20 to 49	465	8	6	5	35	29	26	N/A
	Quantities of 50 to 149	445	8	6	5	35	29	26	N/A
	Quantities of 150 to 249	420	8	6	5	35	29	26	N/A
PC-PH021	Winchester Drive (\$ 1/4" 10MB) Includes Winchester Controller Card								
	Quantities of 1 to 19	2,385	24	16	14	156	132	115	N/A
	Quantities of 20 to 49	2,100	24	16	14	156	132	115	N/A
	Quantities of 50 to 149	2,005	24	16	14	156	132	115	N/A
	Quantities of 150 to 249	1,910	24	16	14	156	132	115	N/A

NOTE: All orders for add-ons and upgrade equipment MUST include the work order numbers and serial numbers of the system components involved.



MODEL NUMBER	DESCRIPTION	PURCHASE PRICE	MONTHLY MAINTENANCE			--- MONTHLY RENTAL PRICES ---			
			PLAN A ON-SITE	PLAN C CARRY-IN	PLAN M MAIL-IN	1 YEAR	2 YEAR	3 YEAR	5 YEAR
<b>OPTIONS PERIPHERAL MODULES (continued)</b>									
PC-PH030	Memory Expansion Card With Parity (128KB)	\$ 510	\$ 5	\$ 4	\$ 3	\$ 34	\$ 29	25	N/A
	Quantities of 1 to 19	450	5	4	3	34	29	25	N/A
	Quantities of 20 to 49	430	5	4	3	34	29	25	N/A
	Quantities of 50 to 149	410	5	4	3	34	29	25	N/A
	Quantities of 150 to 249								
PC-PH031	Memory Expansion Card With Parity (256KB)	840	10	8	6	55	47	41	N/A
	Quantities of 1 to 19	740	10	8	6	55	47	41	N/A
	Quantities of 20 to 49	710	10	8	6	55	47	41	N/A
	Quantities of 50 to 149	675	10	8	6	55	47	41	N/A
	Quantities of 150 to 249								
PC-PH032	Memory Expansion Card With Parity (512KB)	1,685	15	12	9	110	93	81	N/A
	Quantities of 1 to 19	1,485	15	12	9	110	93	81	N/A
	Quantities of 20 to 49	1,420	15	12	9	110	93	81	N/A
	Quantities of 50 to 149	1,320	15	12	9	110	93	81	N/A
	Quantities of 150 to 249								
PC-PH040	PC Remote Communications Option	900	8	7	6	59	50	44	N/A
	Quantities of 1 to 19	795	8	7	6	59	50	44	N/A
	Quantities of 20 to 49	760	8	7	6	59	50	44	N/A
	Quantities of 50 to 149	720	8	7	6	59	50	44	N/A
	Quantities of 150 to 249								
PC-PK2-0A	Professional Workstation Package I Includes: 0A Local Communications, 128KB Memory Expansion Card, Advanced WP, Multiplan, Notebook	3,260	13	11	9	212	180	157	N/A
	Quantities of 1 to 19	2,870	13	11	9	212	180	157	N/A
	Quantities of 20 to 49	2,740	13	11	9	212	180	157	N/A
	Quantities of 50 to 149	2,610	13	11	9	212	180	157	N/A
	Quantities of 150 to 249								
PC-PK2-VS	Professional Workstation Package I Includes: VS Local Communications, 128KB Memory Expansion Card, Advanced WP, Multiplan, Notebook	3,260	13	11	9	212	180	157	N/A
	Quantities of 1 to 19	2,870	13	11	9	212	180	157	N/A
	Quantities of 20 to 49	2,740	13	11	9	212	180	157	N/A
	Quantities of 50 to 149	2,610	13	11	9	212	180	157	N/A
	Quantities of 150 to 249								

NOTE: All orders for add-ons and upgrade equipment MUST include the work order numbers and serial numbers of the system components involved.

MODEL  
NUMBER

DESCRIPTION

PURCHASE  
PRICEMONTHLY  
MAINTENANCEPLAN A  
ON-SITEPLAN C  
CARRY-INPLAN M  
MAIL-IN

---MONTHLY RENTAL PRICES---

1 YEAR

2 YEAR

3 YEAR

5 YEAR

OPTIONS PERIPHERAL MODULES (continued)

PC-PH041-0A	PC Alliance and OIS Local Communications Option (Includes software)	\$ 2,000	8	7	6	130	110	96	N/A
	Quantities of 1 to 19	1,760	8	7	6	130	110	96	N/A
	Quantities of 20 to 49	1,680	8	7	6	130	110	96	N/A
	Quantities of 50 to 149	1,600	8	7	6	130	110	96	N/A
	Quantities of 150 to 249	1,600	8	7	6	130	110	96	N/A
PC-PH041-VS	PC VS Local Communications Option (Includes software)	2,000	8	7	6	130	110	96	N/A
	Quantities of 1 to 19	1,760	8	7	6	130	110	96	N/A
	Quantities of 20 to 49	1,680	8	7	6	130	110	96	N/A
	Quantities of 50 to 149	1,600	8	7	6	130	110	96	N/A
	Quantities of 150 to 249	1,600	8	7	6	130	110	96	N/A
PC-PH042	Multiport Communications Option	500	8	N/A	N/A	33	28	24	N/A
	Quantities of 1 to 19	440	8	N/A	N/A	33	28	24	N/A
	Quantities of 20 to 49	420	8	N/A	N/A	33	28	24	N/A
	Quantities of 50 to 149	400	8	N/A	N/A	33	28	24	N/A
	Quantities of 150 to 249	400	8	N/A	N/A	33	28	24	N/A
PC-PH048	3278 Terminal Emulation Board	900	8	7	6	59	50	44	N/A
	Quantities of 1 to 19	795	8	7	6	59	50	44	N/A
	Quantities of 20 to 49	760	8	7	6	59	50	44	N/A
	Quantities of 50 to 149	720	8	7	6	59	50	44	N/A
	Quantities of 150 to 249	720	8	7	6	59	50	44	N/A
PC-PH050	PC CP/M-80 Emulator Card (Includes Software)	600	10	8	7	39	33	29	N/A
	Quantities of 1 to 19	530	10	8	7	39	33	29	N/A
	Quantities of 20 to 49	505	10	8	7	39	33	29	N/A
	Quantities of 50 to 149	480	10	8	7	39	33	29	N/A
	Quantities of 150 to 249	480	10	8	7	39	33	29	N/A

PRINTER OPTIONS

SSF-20	Single Bin Sheet Feeder for OIS PTR20 and PC-PH012	\$ 500	10	N/A	N/A	N/A	N/A	N/A	N/A
BFT-20	Bidirectional Forms Tractor for OIS-PTR20 and PC-PH012	275	N/A	N/A	N/A	N/A	N/A	N/A	N/A

NOTE: All orders for add-ons and upgrade equipment MUST include the work order numbers and serial numbers of the system components involved.

PC/ 10 - 8

COMPANY CONFIDENTIAL  
REPLACES: 02/01/84  
EFFECTIVE: 05/01/84

PC

MODEL NUMBER	DESCRIPTION	PURCHASE PRICE	MONTHLY MAINTENANCE			---MONTHLY RENTAL PRICES---				
			PLAN A ON-SITE	PLAN C CARRY-IN	PLAN H MAIL-IN	1 YEAR	2 YEAR	3 YEAR	5 YEAR	
<u>LOCAL INTERCONNECT MODULES</u>										
PC-PH070	Local Interconnect Option									
	Quantities of 1 to 19	\$ 400	6	N/A	N/A	\$ 26	\$ 22	\$ 20	N/A	
	Quantities of 20 to 49	355	6	N/A	N/A	26	22	20	N/A	
	Quantities of 50 to 149	340	6	N/A	N/A	26	22	20	N/A	
	Quantities of 150 to 249	320	6	N/A	N/A	26	22	20	N/A	
PC-PH071	Local Interconnect Repeater and (1) Repeater Card									
	Quantities of 1 to 19	600	4	N/A	N/A	39	33	29	N/A	
	Quantities of 20 to 49	530	4	N/A	N/A	39	33	29	N/A	
	Quantities of 50 to 149	505	4	N/A	N/A	39	33	29	N/A	
	Quantities of 150 to 249	480	4	N/A	N/A	39	33	29	N/A	
PC-PH072	Repeater Card									
	Quantities of 1 to 19	400	4	N/A	N/A	26	22	20	N/A	
	Quantities of 20 to 49	355	4	N/A	N/A	26	22	20	N/A	
	Quantities of 50 to 149	340	4	N/A	N/A	26	22	20	N/A	
	Quantities of 150 to 249	320	4	N/A	N/A	26	22	20	N/A	
PC-PH075	PC HangNet Service Option (Includes Professional Network Software)									
	Quantities of 1 to 19	800	8	7	6	52	44	39	N/A	
	Quantities of 20 to 49	705	8	7	6	52	44	39	N/A	
	Quantities of 50 to 149	675	8	7	6	52	44	39	N/A	
	Quantities of 150 to 249	640	8	7	6	52	44	39	N/A	

\* See Supplies Catalog for cable ordering information.

VOICE ATTACHMENT MODULES

PC-VA300	Professional Computer-Voice Attachment									
	Quantities of 1 to 19	\$ 500	5	N/A	N/A	\$ 33	\$ 28	\$ 24	N/A	
	Quantities of 20 to 49	440	5	N/A	N/A	33	28	24	N/A	
	Quantities of 50 to 149	420	5	N/A	N/A	33	28	24	N/A	
	Quantities of 150 to 249	400	5	N/A	N/A	33	28	24	N/A	
PC-VA304	Telemarketing Headset Option	100	N/A	N/A	N/A	7	6	5	N/A	
PC-VA305	Multi-Line Adaptor	40	N/A	N/A	N/A	N/A	N/A	N/A	N/A	

NOTE: All orders for add-ons and upgrade equipment MUST include the work order numbers and serial numbers of the system components involved.



MODEL  
NUMBER

DESCRIPTION

PURCHASE  
PRICEMONTHLY  
MAINTENANCE  
PLAN A  
ON-SITE    PLAN C  
CARRY-IN    PLAN H  
MAIL-IN---MONTHLY RENTAL PRICES---  
1 YEAR    2 YEAR    3 YEAR    5 YEAR

## ACCESSORIES

PC-AC001	Monitor Arm								
	Quantities of 1 to 19	\$ 209	N/A	N/A	N/A	\$ 13	\$ 11	10	N/A
	Quantities of 20 to 49	180	N/A	N/A	N/A	13	11	10	N/A
	Quantities of 50 to 149	170	N/A	N/A	N/A	13	11	10	N/A
PC-AC002	Quantities of 150 to 249	160	N/A	N/A	N/A	13	11	10	N/A
	Desk Clamp								
	Quantities of 1 to 19	125	N/A	N/A	N/A	9	7	6	N/A
	Quantities of 20 to 49	110	N/A	N/A	N/A	9	7	6	N/A
PC-AC004	Quantities of 50 to 149	105	N/A	N/A	N/A	9	7	6	N/A
	Quantities of 150 to 249	100	N/A	N/A	N/A	9	7	6	N/A
	PC to 2200 Cable	50	N/A	N/A	N/A	N/A	N/A	N/A	N/A
PC-AC005	4' PC Keyboard Extension Cable	25	N/A	N/A	N/A	N/A	N/A	N/A	N/A

MODEL  
NUMBER

DESCRIPTION

INITIAL  
LICENSE  
FEEMONTHLY  
LICENSE  
FEE-----MONTHLY RENTAL PRICES-----  
1 YEAR    2 YEAR    3 YEAR    5 YEAR

## PACKAGED SOFTWARE

NOTE: SOFTWARE CANNOT BE RENTED

PC-CS001	Software Productivity Package. PC Multiplan (PC-AS001), PC Word Processing (PC-AS002), and Asynchronous Communica- tions (PC-SS020)								
	Quantities of 1 to 19	\$ 650	N/A		N/A	N/A	N/A	N/A	N/A
	Quantities of 20 to 49	575	N/A		N/A	N/A	N/A	N/A	N/A
	Quantities of 50 to 149	550	N/A		N/A	N/A	N/A	N/A	N/A
PC-CS002	Quantities of 150 to 249	520	N/A		N/A	N/A	N/A	N/A	N/A
	Software Productivity Package II Includes: Multiplan, Advanced WP, Asynchronous Communications								
	Quantities of 1 to 19	700	N/A		N/A	N/A	N/A	N/A	N/A
	Quantities of 20 to 49	620	N/A		N/A	N/A	N/A	N/A	N/A
PC-CS002	Quantities of 50 to 149	590	N/A		N/A	N/A	N/A	N/A	N/A
	Quantities of 150 to 249	560	N/A		N/A	N/A	N/A	N/A	N/A

NOTE: All orders for add-ons and upgrade equipment MUST include the work order numbers and serial numbers of the system components involved.

PC/ 10 - 10

COMPANY CONFIDENTIAL  
REPLACES: 02/01/84  
EFFECTIVE: 05/01/84

PC

MODEL NUMBER	DESCRIPTION	INITIAL LICENSE FEE	MONTHLY LICENSE FEE	----- MONTHLY RENTAL PRICES -----			
				1 YEAR	2 YEAR	3 YEAR	5 YEAR
<b>PACKAGED SOFTWARE</b>							
NOTE: SOFTWARE CANNOT BE RENTED							
PC-CS003	MICRO FOCUS, Level II COBOL Programming Environment (Includes MICRO FOCUS, Level II COBOL, FORMS-2 and ANIMATOR)						
	Quantities of 1 to 19	\$ 1,750	N/A	N/A	N/A	N/A	N/A
	Quantities of 20 to 49	1,540	N/A	N/A	N/A	N/A	N/A
	Quantities of 50 to 149	1,470	N/A	N/A	N/A	N/A	N/A
	Quantities of 150 to 249	1,400	N/A	N/A	N/A	N/A	N/A
PC-CS004	Professional Data Management Package Includes: Database and Business Graphics						
	Quantities of 1 to 19	850	N/A	N/A	N/A	N/A	N/A
	Quantities of 20 to 49	750	N/A	N/A	N/A	N/A	N/A
	Quantities of 50 to 149	715	N/A	N/A	N/A	N/A	N/A
	Quantities of 150 to 249	680	N/A	N/A	N/A	N/A	N/A
<b>APPLICATION SOFTWARE</b>							
NOTE: SOFTWARE CANNOT BE RENTED							
PC-AS001	PC Multiplan						
	Quantities of 1 to 19	\$ 245	N/A	N/A	N/A	N/A	N/A
	Quantities of 20 to 49	220	N/A	N/A	N/A	N/A	N/A
	Quantities of 50 to 149	210	N/A	N/A	N/A	N/A	N/A
	Quantities of 150 to 249	200	N/A	N/A	N/A	N/A	N/A
PC-AS002	PC Word Processing						
	Quantities of 1 to 19	400	N/A	N/A	N/A	N/A	N/A
	Quantities of 20 to 49	355	N/A	N/A	N/A	N/A	N/A
	Quantities of 50 to 149	340	N/A	N/A	N/A	N/A	N/A
	Quantities of 150 to 249	320	N/A	N/A	N/A	N/A	N/A
PC-AS002-2	PC Advanced Word Processing						
	Quantities of 1 to 19	500	N/A	N/A	N/A	N/A	N/A
	Quantities of 20 to 49	440	N/A	N/A	N/A	N/A	N/A
	Quantities of 50 to 149	420	N/A	N/A	N/A	N/A	N/A
	Quantities of 150 to 249	400	N/A	N/A	N/A	N/A	N/A
PC-AS003	PC Business Graphics						
	Quantities of 1 to 19	300	N/A	N/A	N/A	N/A	N/A
	Quantities of 20 to 49	265	N/A	N/A	N/A	N/A	N/A
	Quantities of 50 to 149	255	N/A	N/A	N/A	N/A	N/A
	Quantities of 150 to 249	240	N/A	N/A	N/A	N/A	N/A

NOTE: All orders for add-ons and upgrade equipment MUST include the work order numbers and serial numbers of the system components involved.

MODEL NUMBER	DESCRIPTION	INITIAL LICENSE FEE	MONTHLY LICENSE FEE	-----MONTHLY RENTAL PRICES-----			
				1 YEAR	2 YEAR	3 YEAR	5 YEAR
<u>APPLICATION SOFTWARE</u> (continued)							
NOTE: SOFTWARE CANNOT BE RENTED							
PC-AS004	PC Data Base						
	Quantities of 1 to 19	\$ 650	N/A	N/A	N/A	N/A	N/A
	Quantities of 20 to 49	575	N/A	N/A	N/A	N/A	N/A
	Quantities of 50 to 149	850	N/A	N/A	N/A	N/A	N/A
	Quantities of 150 to 249	520	N/A	N/A	N/A	N/A	N/A
PC-AS005	PC Notebook						
	Quantities of 1 to 19	200	N/A	N/A	N/A	N/A	N/A
	Quantities of 20 to 49	180	N/A	N/A	N/A	N/A	N/A
	Quantities of 50 to 149	170	N/A	N/A	N/A	N/A	N/A
	Quantities of 150 to 249	160	N/A	N/A	N/A	N/A	N/A
PC-AS009	PC OFFICE						
	Quantities of 1 to 19	495	N/A	N/A	N/A	N/A	N/A
	Quantities of 20 to 49	440	N/A	N/A	N/A	N/A	N/A
	Quantities of 50 to 149	420	N/A	N/A	N/A	N/A	N/A
	Quantities of 150 to 249	400	N/A	N/A	N/A	N/A	N/A
PC-AS012	PC Multistation						
	Quantities of 1 to 19	295	N/A	N/A	N/A	N/A	N/A
	Quantities of 20 to 49	260	N/A	N/A	N/A	N/A	N/A
	Quantities of 50 to 149	250	N/A	N/A	N/A	N/A	N/A
	Quantities of 150 to 249	240	N/A	N/A	N/A	N/A	N/A
PC-AS014	Wang Random House Electronic Thesaurus						
	Quantities of 1 to 19	150	2	N/A	N/A	N/A	N/A
	Quantities of 20 to 49	135	2	N/A	N/A	N/A	N/A
	Quantities of 50 to 149	130	2	N/A	N/A	N/A	N/A
	Quantities of 150 to 249	120	2	N/A	N/A	N/A	N/A
<u>SYSTEM SOFTWARE</u>							
NOTE: SOFTWARE CANNOT BE RENTED							
PC-SS001	System Software Diskette Wang Menu Enhanced MS-DOS Operating System, Plus Interpretive BASIC (Included with all Systems)						
	Quantities of 1 to 19	\$ 200	N/A	N/A	N/A	N/A	N/A
	Quantities of 20 to 49	180	N/A	N/A	N/A	N/A	N/A
	Quantities of 50 to 149	170	N/A	N/A	N/A	N/A	N/A
	Quantities of 150 to 249	160	N/A	N/A	N/A	N/A	N/A
PC-SS002	UCSD-p Runtime System						
	Quantities of 1 to 19	100	N/A	N/A	N/A	N/A	N/A
	Quantities of 20 to 49	90	N/A	N/A	N/A	N/A	N/A
	Quantities of 50 to 149	85	N/A	N/A	N/A	N/A	N/A
	Quantities of 150 to 249	80	N/A	N/A	N/A	N/A	N/A

NOTE: All orders for add-ons and upgrade equipment MUST include the work order numbers and serial numbers of the system components involved.



MODEL NUMBER	DESCRIPTION	INITIAL LICENSE FEE	MONTHLY LICENSE FEE	-----MONTHLY RENTAL PRICES-----				
				1 YEAR	2 YEAR	3 YEAR	5 YEAR	
<u>SYSTEM SOFTWARE (continued)</u>								
NOTE: SOFTWARE CANNOT BE RENTED								
PC-SS005	CP/M 80 Emulation Software							
	Quantities of 1 to 19	\$ 240	N/A	N/A	N/A	N/A	N/A	N/A
	Quantities of 20 to 49	215	N/A	N/A	N/A	N/A	N/A	N/A
	Quantities of 50 to 149	205	N/A	N/A	N/A	N/A	N/A	N/A
	Quantities of 150 to 249	195	N/A	N/A	N/A	N/A	N/A	N/A
PC-SS010	MS-Compiled BASIC							
	Quantities of 1 to 19	295	N/A	N/A	N/A	N/A	N/A	N/A
	Quantities of 20 to 49	260	N/A	N/A	N/A	N/A	N/A	N/A
	Quantities of 50 to 149	250	N/A	N/A	N/A	N/A	N/A	N/A
	Quantities of 150 to 249	240	N/A	N/A	N/A	N/A	N/A	N/A
PC-SS011	MS-PASCAL							
	Quantities of 1 to 19	295	N/A	N/A	N/A	N/A	N/A	N/A
	Quantities of 20 to 49	260	N/A	N/A	N/A	N/A	N/A	N/A
	Quantities of 50 to 149	250	N/A	N/A	N/A	N/A	N/A	N/A
	Quantities of 150 to 249	240	N/A	N/A	N/A	N/A	N/A	N/A
PC-SS012	MS-FORTRAN							
	Quantities of 1 to 19	345	N/A	N/A	N/A	N/A	N/A	N/A
	Quantities of 20 to 49	305	N/A	N/A	N/A	N/A	N/A	N/A
	Quantities of 50 to 149	290	N/A	N/A	N/A	N/A	N/A	N/A
	Quantities of 150 to 249	280	N/A	N/A	N/A	N/A	N/A	N/A
PC-SS013	MS-COBOL							
	Quantities of 1 to 19	695	N/A	N/A	N/A	N/A	N/A	N/A
	Quantities of 20 to 49	615	N/A	N/A	N/A	N/A	N/A	N/A
	Quantities of 50 to 149	585	N/A	N/A	N/A	N/A	N/A	N/A
	Quantities of 150 to 249	560	N/A	N/A	N/A	N/A	N/A	N/A
PC-SS015	PC Advanced BASIC Compiler							
	Quantities of 1 to 19	295	N/A	N/A	N/A	N/A	N/A	N/A
	Quantities of 20 to 49	260	N/A	N/A	N/A	N/A	N/A	N/A
	Quantities of 50 to 149	250	N/A	N/A	N/A	N/A	N/A	N/A
	Quantities of 150 to 249	240	N/A	N/A	N/A	N/A	N/A	N/A
PC-SS016	PC BASIC 2							
	Quantities of 1 to 19	395	N/A	N/A	N/A	N/A	N/A	N/A
	Quantities of 20 to 49	350	N/A	N/A	N/A	N/A	N/A	N/A
	Quantities of 50 to 149	335	N/A	N/A	N/A	N/A	N/A	N/A
	Quantities of 150 to 249	320	N/A	N/A	N/A	N/A	N/A	N/A

NOTE: All orders for add-ons and upgrade equipment MUST include the work order numbers and serial numbers of the system components involved.

MODEL NUMBER	DESCRIPTION	INITIAL LICENSE FEE	MONTHLY LICENSE FEE	----- MONTHLY RENTAL PRICES -----				
				1 YEAR	2 YEAR	3 YEAR	5 YEAR	
<u>SYSTEM SOFTWARE (continued)</u>								
NOTE: SOFTWARE CANNOT BE RENTED								
PC-SS020	PC Asynchronous Communications Option (Includes 22360W Emulation)							
	Quantities of 1 to 19	\$ 100	N/A	N/A	N/A	N/A	N/A	N/A
	Quantities of 20 to 49	90	N/A	N/A	N/A	N/A	N/A	N/A
	Quantities of 50 to 149	85	N/A	N/A	N/A	N/A	N/A	N/A
	Quantities of 150 to 249	80	N/A	N/A	N/A	N/A	N/A	N/A
PC-SS022	MICRO FOCUS, Level II COBOL Compiler							
	Quantities of 1 to 19	1,500	N/A	N/A	N/A	N/A	N/A	N/A
	Quantities of 20 to 49	1,320	N/A	N/A	N/A	N/A	N/A	N/A
	Quantities of 50 to 149	1,260	N/A	N/A	N/A	N/A	N/A	N/A
	Quantities of 150 to 249	1,200	N/A	N/A	N/A	N/A	N/A	N/A
PC-SS023	MICRO FOCUS, FORMS-2 (Requires PC-SS022)							
	Quantities of 1 to 19	150	N/A	N/A	N/A	N/A	N/A	N/A
	Quantities of 20 to 49	135	N/A	N/A	N/A	N/A	N/A	N/A
	Quantities of 50 to 149	130	N/A	N/A	N/A	N/A	N/A	N/A
	Quantities of 150 to 249	120	N/A	N/A	N/A	N/A	N/A	N/A
PC-SS024	MICRO FOCUS, ANIMATOR (Requires PC-SS022)							
	Quantities of 1 to 19	500	N/A	N/A	N/A	N/A	N/A	N/A
	Quantities of 20 to 49	440	N/A	N/A	N/A	N/A	N/A	N/A
	Quantities of 50 to 149	420	N/A	N/A	N/A	N/A	N/A	N/A
	Quantities of 150 to 249	400	N/A	N/A	N/A	N/A	N/A	N/A
PC-SS035	Local Communications File Sharer							
	Quantities of 1 to 19	500	N/A	N/A	N/A	N/A	N/A	N/A
	Quantities of 20 to 49	440	N/A	N/A	N/A	N/A	N/A	N/A
	Quantities of 50 to 149	420	N/A	N/A	N/A	N/A	N/A	N/A
	Quantities of 150 to 249	400	N/A	N/A	N/A	N/A	N/A	N/A
PC-SS036	PC Graphics Workstation Emulation Software							
	Quantities of 1 to 19	200	N/A	N/A	N/A	N/A	N/A	N/A
	Quantities of 20 to 49	180	N/A	N/A	N/A	N/A	N/A	N/A
	Quantities of 50 to 149	170	N/A	N/A	N/A	N/A	N/A	N/A
	Quantities of 150 to 249	160	N/A	N/A	N/A	N/A	N/A	N/A
PC-SS060	2780/3780/WPS Option For PC							
	Quantities of 1 to 19	200	N/A	N/A	N/A	N/A	N/A	N/A
	Quantities of 20 to 49	180	N/A	N/A	N/A	N/A	N/A	N/A
	Quantities of 50 to 149	170	N/A	N/A	N/A	N/A	N/A	N/A
	Quantities of 150 to 249	160	N/A	N/A	N/A	N/A	N/A	N/A

NOTE: All orders for add-ons and upgrade equipment MUST include the work order numbers and serial numbers of the system components involved.



MODEL NUMBER	DESCRIPTION	INITIAL LICENSE FEE	MONTHLY LICENSE FEE	-----MONTHLY RENTAL PRICES-----				
				1 YEAR	2 YEAR	3 YEAR	5 YEAR	
<b>SYSTEM SOFTWARE (continued)</b>								
NOTE: SOFTWARE CANNOT BE RENTED								
PC-SS062	3276/3275 BSC Quantities of 1 to 19 Quantities of 20 to 49 Quantities of 50 to 149 Quantities of 150 to 249	\$ 400 355 340 320	N/A N/A N/A N/A	N/A N/A N/A N/A	N/A N/A N/A N/A	N/A N/A N/A N/A	N/A N/A N/A N/A	N/A N/A N/A N/A
PC-SS063	3276 SNA/SDLC Emulation Quantities of 1 to 19 Quantities of 20 to 49 Quantities of 50 to 149 Quantities of 150 to 249	400 355 340 320	N/A N/A N/A N/A	N/A N/A N/A N/A	N/A N/A N/A N/A	N/A N/A N/A N/A	N/A N/A N/A N/A	N/A N/A N/A N/A
PC-SS065	3278 Emulation Quantities of 1 to 19 Quantities of 20 to 49 Quantities of 50 to 149 Quantities of 150 to 249	240 215 205 195	N/A N/A N/A N/A	N/A N/A N/A N/A	N/A N/A N/A N/A	N/A N/A N/A N/A	N/A N/A N/A N/A	N/A N/A N/A N/A
PC-SS070	PC Voice Attachment Programmer Utilities Quantities of 1 to 19 Quantities of 20 to 49 Quantities of 50 to 149 Quantities of 150 to 249	200 180 170 160	N/A N/A N/A N/A	N/A N/A N/A N/A	N/A N/A N/A N/A	N/A N/A N/A N/A	N/A N/A N/A N/A	N/A N/A N/A N/A
PC-SS080	Professional Network Services for Local Interconnect Option	500	N/A	N/A	N/A	N/A	N/A	N/A
<b>WANG SYSTEMS NETWORKING SOFTWARE</b>								
PC-WSNT-MS	PC WSN Multipoint Secondary Transport Quantities of 1 to 19 Quantities of 20 to 49 Quantities of 50 to 149 Quantities of 150 to 249	\$ 250 220 210 200	N/A N/A N/A N/A	N/A N/A N/A N/A	N/A N/A N/A N/A	N/A N/A N/A N/A	N/A N/A N/A N/A	N/A N/A N/A N/A
PC-WSNT-PP	PC WSN Point-Point Transport Quantities of 1 to 19 Quantities of 20 to 49 Quantities of 50 to 149 Quantities of 150 to 249	250 220 210 200	N/A N/A N/A N/A	N/A N/A N/A N/A	N/A N/A N/A N/A	N/A N/A N/A N/A	N/A N/A N/A N/A	N/A N/A N/A N/A
PC-WSNT-X25	PC WSN X.25 Transport Quantities of 1 to 19 Quantities of 20 to 49 Quantities of 50 to 149 Quantities of 150 to 249	250 220 210 200	N/A N/A N/A N/A	N/A N/A N/A N/A	N/A N/A N/A N/A	N/A N/A N/A N/A	N/A N/A N/A N/A	N/A N/A N/A N/A

NOTE: All orders for add-ons and upgrade equipment MUST include the work order numbers and serial numbers of the system components involved.

MODEL NUMBER	DESCRIPTION	INITIAL LICENSE FEE	MONTHLY LICENSE FEE	-----MONTHLY RENTAL PRICES-----			
				1 YEAR	2 YEAR	3 YEAR	5 YEAR
WANG SYSTEMS NETWORKING SOFTWARE (continued)							
PC-MSMS-BSS	PC BASIC Support Services for MSN File Transfer and VS DP Terminal Emulation						
	Quantities of 1 to 19	\$ 100	N/A	N/A	N/A	N/A	N/A
	Quantities of 20 to 49	90	N/A	N/A	N/A	N/A	N/A
	Quantities of 50 to 149	85	N/A	N/A	N/A	N/A	N/A
	Quantities of 150 to 249	80	N/A	N/A	N/A	N/A	N/A
195-2781-9	PC VT-100 Emulation						
	Quantities of 1 to 19	200	N/A	N/A	N/A	N/A	N/A
	Quantities of 20 to 49	180	N/A	N/A	N/A	N/A	N/A
	Quantities of 50 to 149	170	N/A	N/A	N/A	N/A	N/A
	Quantities of 150 to 249	160	N/A	N/A	N/A	N/A	N/A
PC-VT500	PC Viewdata Decoder Software Supports the Prestel Protocol						
	Quantities of 1 to 19	250	N/A	N/A	N/A	N/A	N/A
	Quantities of 20 to 49	220	N/A	N/A	N/A	N/A	N/A
	Quantities of 50 to 149	210	N/A	N/A	N/A	N/A	N/A
	Quantities of 150 to 249	200	N/A	N/A	N/A	N/A	N/A

UPGRADE JOB #	DESCRIPTION	PURCHASE PRICE	-----R E N T A L-----	
			SINGLE OR MONTHLY CHARGE	1 YEAR

The purchase/rental charges listed include any applicable difference in prices. For purchase systems the incremental maintenance charge is also due.

SOFTWARE UPGRADES

UJ-3199	Upgrade to Enhanced MS/DOS Operating System	\$ 100	N/A	N/A
UJ-3200	Upgrade to Advanced PC Word Processing	150	N/A	N/A
UJ-3201	Upgrade to Enhanced Local Communications	50	N/A	N/A
PC-WIN	Upgrade to MS Windows	100	N/A	N/A

NOTE: All orders for add-ons and upgrade equipment MUST include the work order numbers and serial numbers of the system components involved.



WANG PROFESSIONAL COMPUTER TERMS AND CONDITIONS

Discounts are allowed for quantity purchases (sales only; no rentals except as noted on exception basis\*). Orders must be submitted on a single purchase order, delivery may be to multiple delivery points, but must be within six (6) months of initial order\*. Quantity discounts are applied per model number not on an aggregate basis except as noted on an exception basis\*. Products for which Wang publishes multi-unit discounts shall receive the higher of the applicable published multi-unit quantity discount; or the Annual Volume Agreement discount, but not both.

- \* PC deliveries must be made within twelve (12) months of initial order.
- \* PC allows aggregation of models PC-001, 002, 003B, 004A, 005A, 006, XC1, XC2, XC3, and XC4.

NOTE: All orders for add-ons and upgrade equipment MUST include the work order numbers and serial numbers of the system components involved.



COMPANY CONFIDENTIAL

Effective Date: MAY 1, 1984

-Prices and equipment availability subject to change without notice-

PROFESSIONAL IMAGE COMPUTER PRODUCT LINE PRICE LIST

TABLE OF CONTENTS

<u>DESCRIPTION</u>	<u>PAGE</u>	<u>EFFECTIVE DATE</u>
IMAGE BASE SYSTEM	2	05/01/84
WORKSTATION	2	05/01/84
STARTER KIT	3	05/01/84
OPTIONS	3	05/01/84
SOFTWARE	4	05/01/84
UPGRADES	5	05/01/84
TERMS AND CONDITIONS	5	05/01/84



CONFIDENTIAL

**INSTALLATION CHARGE**

The Professional Image Computer is a customer installable machine. Detailed installation instructions are included with each unit. The customer is responsible for unpacking system components, attaching them correctly, and running the diagnostic program. Installation services from Wang Laboratories, Inc. is available for a fee of \$200 per Professional Computer system, plus any distance surcharges that may be applicable.

WANG

COMPANY CONFIDENTIAL

MODEL  
NUMBER

DESCRIPTION

PURCHASE  
PRICE

MONTHLY  
MAINTENANCE  
(On Site Only)

-----MONTHLY RENTAL PRICES-----  
1 YEAR 2 YEAR 3 YEAR 5 YEAR

IMAGE BASE SYSTEM

PIC-1008

Image Base System  
PIC-PH01, Image Monitor  
PIC-PH02, Text/Image/Graph-  
ics/Card  
PIC-PH03, Image/Scanner  
PIC-PH05, Scanner/Printer  
Card  
PIC-AS01, Image Processing  
Core Software  
PC-PH032, Memory Expansion  
Card  
PC-XC3, Expanded Chassis  
Base Unit, 10MB  
Winchester Disk,  
Keyboard, 128K  
Main Memory, PC  
Software

\$ 14,965      \$ 135      \$ 973 \$ 824 \$ 719      N/A

WORKSTATION

PIC-1005

Image Workstation  
PIC-PH01, Image Monitor  
PIC-PH02, Text/Image/Graph-  
ics Card  
PIC-AS01, Image Processing  
Core Software  
PC-001, Base PC Unit,  
(128KB) Diskette,  
Keyboard, PC Soft-  
ware  
PC-PH021, 10MB Winchester  
Controller  
PC-PH032, Memory Expansion  
Card  
PC-PH041, PC Local Commu-  
nications Option  
Quantities of 1 to 19  
Quantities of 20 to 49  
Quantities of 50 to 149  
Quantities of 150 to 249

\$ 12,115      \$ 93      \$ 788 \$ 667 \$ 582      N/A  
10,665      93      788      667      582      N/A  
10,180      93      788      667      582      N/A  
9,695      93      788      667      582      N/A

NOTE: PIC-1005 also requires PIC-CS01

NOTE: All orders for add-ons and upgrade equipment MUST include the work order numbers and serial numbers of the system components involved.



MODEL NUMBER	DESCRIPTION	PURCHASE PRICE	MONTHLY MAINTENANCE (On Site Only)	-----MONTHLY RENTAL PRICES-----			
				1 YEAR	2 YEAR	3 YEAR	5 YEAR
<b>STARTER KIT</b>							
PIC-KIT-1	PIC Starter Package PIC-1008, Imaging System PIC-PH01, Image Monitor PIC-PH02, Text/Image/Graphics Card PIC-AS01, Image Processing Core Software PIC-CS03, Image Communications PC-001, Base PC Unit, 128K, Diskette, Keyboard PC-PH021, 10MB Winchester Controller PC-PH032, Memory Expansion Card PC-PH070, Local Interconnect PC-SS080, Local Interconnect Software	\$ 26,730	\$ 230	\$ 1,738	\$ 1,471	\$ 1,284	N/A
<b>OPTIONS</b>							
PIC-PH01	Image Monitor CRT/BASE	\$ 750	\$ 7	\$ 49	\$ 42	\$ 36	N/A
	Quantities of 1 to 19	660	7	49	42	36	N/A
	Quantities of 20 to 49	630	7	49	42	36	N/A
	Quantities of 50 to 149	600	7	49	42	36	N/A
	Quantities of 150 to 249						
PIC-PH02	Text/Image/Graphics Controller	1,200	39	78	66	58	N/A
	Quantities of 1 to 19	1,060	39	78	66	58	N/A
	Quantities of 20 to 49	1,010	39	78	66	58	N/A
	Quantities of 50 to 149	960	39	78	66	58	N/A
	Quantities of 150 to 249						
PIC-PH03	Image Scanner	3,500	39	228	193	168	N/A
PIC-PH04	Thermal Printer	1,875	15	122	104	90	N/A
PIC-PH05	Scanner/Printer Card	1,000	8	65	55	48	N/A

NOTE: All orders for add-ons and upgrade equipment MUST include the work order numbers and serial numbers of the system components involved.

MODEL NUMBER	DESCRIPTION	INITIAL LICENSE FEE	MONTHLY LICENSE FEE	-----MONTHLY RENTAL PRICES-----			
				1 YEAR	2 YEAR	3 YEAR	5 YEAR
<u>SOFTWARE</u>							
PIC-AS01	Image Processing Core Software (Required of all imaging stations) Includes Image Processing and Image Composition						
	Quantities of 1 to 19	\$ 1,500	\$ 15	N/A	N/A	N/A	N/A
	Quantities of 20 to 49	1,320	15	N/A	N/A	N/A	N/A
	Quantities of 50 to 149	1,260	15	N/A	N/A	N/A	N/A
	Quantities of 150 to 249	1,200	15	N/A	N/A	N/A	N/A
PIC-AS02	Integrated Word Processing						
	Quantities of 1 to 19	1,000	10	N/A	N/A	N/A	N/A
	Quantities of 20 to 49	880	10	N/A	N/A	N/A	N/A
	Quantities of 50 to 149	840	10	N/A	N/A	N/A	N/A
	Quantities of 150 to 249	800	10	N/A	N/A	N/A	N/A
PIC-AS009	Wang Random House Thesaurus						
	Quantities of 1 to 19	150	2	N/A	N/A	N/A	N/A
	Quantities of 20 to 49	135	2	N/A	N/A	N/A	N/A
	Quantities of 50 to 149	130	2	N/A	N/A	N/A	N/A
	Quantities of 150 to 249	120	2	N/A	N/A	N/A	N/A
PIC-AS03	Integrated Database						
	Quantities of 1 to 19	800	8	N/A	N/A	N/A	N/A
	Quantities of 20 to 49	705	8	N/A	N/A	N/A	N/A
	Quantities of 50 to 149	675	8	N/A	N/A	N/A	N/A
	Quantities of 150 to 249	640	8	N/A	N/A	N/A	N/A
PIC-AS04	Integrated Notebook						
	Quantities of 1 to 19	350	4	N/A	N/A	N/A	N/A
	Quantities of 20 to 49	310	4	N/A	N/A	N/A	N/A
	Quantities of 50 to 149	295	4	N/A	N/A	N/A	N/A
	Quantities of 150 to 249	280	4	N/A	N/A	N/A	N/A
PIC-AS05	Image Forms-F111						
	Quantities of 1 to 19	750	8	N/A	N/A	N/A	N/A
	Quantities of 20 to 49	660	8	N/A	N/A	N/A	N/A
	Quantities of 50 to 149	630	8	N/A	N/A	N/A	N/A
	Quantities of 150 to 249	600	8	N/A	N/A	N/A	N/A
PIC-AS08	PIC Programmer Utilities						
	Quantities of 1 to 19	250	3	N/A	N/A	N/A	N/A
	Quantities of 20 to 49	220	3	N/A	N/A	N/A	N/A
	Quantities of 50 to 149	210	3	N/A	N/A	N/A	N/A
	Quantities of 150 to 249	200	3	N/A	N/A	N/A	N/A

NOTE: All orders for add-ons and upgrade equipment MUST include the work order numbers and serial numbers of the system components involved.

PIC/ 11 - 4

COMPANY CONFIDENTIAL  
REPLACES: 02/01/84  
EFFECTIVE: 05/01/84



MODEL NUMBER	DESCRIPTION	INITIAL LICENSE FEE	MONTHLY LICENSE FEE	-----MONTHLY RENTAL PRICES-----			
				1 YEAR	2 YEAR	3 YEAR	5 YEAR
<u>SOFTWARE (continued)</u>							
PIC-CS01	Image Communications for Local Communications Option						
	Quantities of 1 to 19	\$ 395	\$ 4	N/A	N/A	N/A	N/A
	Quantities of 20 to 49	350	4	N/A	N/A	N/A	N/A
	Quantities of 50 to 149	338	4	N/A	N/A	N/A	N/A
	Quantities of 150 to 249	320	4	N/A	N/A	N/A	N/A
PIC-CS02	Image Communications for Remote Communications Option						
	Quantities of 1 to 19	295	3	N/A	N/A	N/A	N/A
	Quantities of 20 to 49	260	3	N/A	N/A	N/A	N/A
	Quantities of 50 to 149	250	3	N/A	N/A	N/A	N/A
	Quantities of 150 to 249	240	3	N/A	N/A	N/A	N/A
PIC-CS03	Image Communications for Local Interconnect Option						
	Quantities of 1 to 19	350	4	N/A	N/A	N/A	N/A
	Quantities of 20 to 49	310	4	N/A	N/A	N/A	N/A
	Quantities of 50 to 149	295	4	N/A	N/A	N/A	N/A
	Quantities of 150 to 249	280	4	N/A	N/A	N/A	N/A

UPGRADE JOB #	DESCRIPTION	PURCHASE PRICE	-----R E N T A L-----	
			SINGLE OR MONTHLY CHARGE	1 YEAR
The purchase/rental charges listed include any applicable difference in prices. For purchase systems the incremental maintenance charge is also due.				

<u>UPGRADES</u>					
UJ-3219	Image Monitor, Text/Image/Graphics Card, Image Processing Core Software	\$ 3,750	\$	N/A	N/A
UJ-3220	Image Monitor, Text/Image/Graphics Card, Image Processing Core Software, Image Scanner, Scanner/ Printer Card	8,250		N/A	N/A

WANG PROFESSIONAL IMAGE COMPUTER TERMS AND CONDITIONS

Discounts are allowed for quantity purchases (sales only; no rentals except as noted on exception basis\*). Orders must be submitted on a single purchase order, delivery may be to multiple delivery points, but must be within six (6) months of initial order\*. Quantity discounts are applied per model number not on an aggregate basis except as noted on an exception basis\*. Products for which Wang publishes multi-unit discounts shall receive the higher of the applicable published multi-unit quantity discount, or the Annual Volume Agreement discount, but not both.

\* PIC deliveries must be made within twelve (12) months of initial order.  
 NOTE: All orders for add-ons and upgrade equipment MUST include the work order numbers and serial numbers of the system components involved.

GENERAL INFORMATION

All orders for purchase must be accompanied by a standard WANG UNIFORM AGREEMENT.

All orders for rental must be accompanied by a WANG MASTER RENTAL AGREEMENT.

A 2% cash discount on purchased products is applicable if payment is received by Wang within ten days prior to the scheduled or actual delivery date of the equipment.

A 6% DISCOUNT ON RENTAL AGREEMENTS IS APPLICABLE IF PAYMENT OF AN ANNUAL RENTAL AGREEMENT IS RECEIVED BY WANG WITHIN 30 DAYS OF THE ANNUAL INVOICING.

WANG QUANTITY DISCOUNT POLICY

1. Discounts are allowed for quantity purchases (sales only: no rentals except as noted on exception basis\*).
2. Orders must be submitted on a single purchase order, delivery may be to multiple delivery points, but must be within six (6) months of initial order\*\*.
3. Quantity discounts are applied per model number not on an aggregate basis except as noted on an exception basis\*\*.
4. Products for which Wang publishes multi-unit discounts shall receive the higher of the applicable published multi-unit quantity discount, or the Annual Volume Agreement discount, but not both.
- \* Quantity discounts for the General Workstation Upgrade Discount apply to both purchase and rental (Single Charge) prices. Discounts apply only to delivery at a single location, not to multiple delivery points.

QUANTITY ORDERED	DISCOUNT
1 - 19	0%
20 - 39	10%
40 +	15%

Computation of the discount for upgrades is calculated on either the full purchase price or the rental single charge. It does not affect the actual rental or maintenance due.

\*\* PC and PIC deliveries must be made within twelve (12) months of initial order. PC allows aggregation of models PC-001, 002, 003B, 004A, 005A, 006, XC1, XC2, XC3 and XC4.

\*\* 4200 Series Workstations that are eligible for quantity discounts (model numbers 4205, 4210, 4220 and 4230) can also be aggregated to qualify for discounts. The 4250 has its own discount schedule and cannot be aggregated.

ENHANCED SOFTWARE DISCOUNTS

Customers signing new Annual Volume Discount Agreements after July 1, 1983 will receive software discounts equal to twice the applicable hardware discounts. Any AVDA discounts, hardware or software, are in lieu of, and not in addition to, any other multi-unit or similar discounts. Therefore, PC Software, Alliance Software, OIS-BASIC-9, or any other software for which multi-unit discounts are published will be eligible for either the applicable multi-unit discount, or the applicable 2X AVDA discount based on the single-unit price, but not both.

For rentals of less than one year, the rental rate is 7.0% of list purchase price for all rentable products. Prices should be rounded to the next whole dollar.

NOTE: If the 7% rental rate is lower than the one year rental rate, then the one year rental rate applies for rentals of less than one year.

PURCHASE OPTION CREDITS

Customer may purchase any Hardware rented hereunder, provided Customer is not in arrears and not in default, at the unit purchase price less the purchase option credit specified below. Purchase credits are not transferable, and may only be applied to the purchase of Hardware in connection with which the credits have accrued.



WANG

COMPANY CONFIDENTIAL



During the first ninety (90) days of any rental Supplement, Customer may exercise the purchase option and Wang shall credit ninety percent (90%) of the basic monthly rental payments paid during such period. If Customer exercises the purchase option after the first ninety (90) days thereof, Wang shall credit forty percent (40%) of the basic monthly rental payments made from Rental Commencement Date, up to a maximum of fifty percent (50%) of the list price when the initial rental order was accepted by WLI on all Hardware except Word Processing System (WPS) Hardware. For Word Processing System (WPS) Hardware, Wang shall credit fifty percent (50%) of the basic monthly rental payments made from Rental Commencement Date up to a maximum of fifty percent (50%) of the list price when the initial rental order was accepted by WLI. All purchase option credits which have accrued hereunder, including any renewal Rental Terms, will be applied upon Customer's purchase of the Hardware provided that the Hardware has been under continuous rental to Customer since the Rental Commencement Date.

#### **RENTAL RENEWALS/CONVERSIONS**

Hardware installed hereunder may be discontinued at the end of the Rental Term indicated on the Supplement by either party provided that sixty (60) days prior written notice is sent to the other's Home Office.

Under one (1) and two (2) year rental Supplements-At the end of each Rental Term, if not terminated, the Supplement will automatically renew for the same term as the initial Rental Term at the then current terms, conditions and prices. Purchase option credits will continue to accrue during renewal Rental Terms up to the maximum allowable credit.

For three (3) and five (5) year rental Supplements which are not terminated or renewed at the end of the Rental Term, the Supplement will automatically renew for one year periods at the then current terms, conditions and prices.

During the first ninety (90) days of any one (1) or two (2) year Rental Supplement, Customer may, without penalty, convert such Supplement into a three (3) or five (5) year Supplement. In order to exercise such conversion option, Customer must enter into a three (3) or five (5) year Supplement at the then current terms, conditions and prices.

#### **INVESTMENT TAX CREDIT**

Customers are entitled to take the Investment Tax Credit on the purchase of newly manufactured equipment. Wang Laboratories, Inc., as policy does not pass through the Investment Tax Credit on rentals. By law, customers are not entitled to the Investment Tax Credit on equipment originally rented where the Investment Tax Credit was not passed through at the beginning of the rental and where the equipment was subsequently purchased, i.e., conversion of rental to purchase.

#### **SUPPLIES**

Consult the Wang Supplies Catalog for product pricing information relating to supplies offered by Wang Laboratories, Inc.

#### **Maintenance Contract Minimum System Configuration**

Wang's ability to effectively and efficiently service Wang hardware is dependent on applying unique diagnostic programs, services and techniques to the hardware system, and then evaluating the resultant system response.

Wang Maintenance Contract Service eligibility is contingent upon an acceptable minimum Wang System configuration. If a Customer's system configuration does not meet Wang's minimum system configuration requirements, maintenance service will be available on a time and materials basis to Per-Call Customers.

NOTE: Reference C.E. Section II H for additional information.

#### **MAINTENANCE**

Maintenance does not include furnishing or replacing expendable supply items (such as magnetic media, type elements, ribbons, etc.), or accessories; painting or refinishing the Equipment or furnishing materials therefore; making specification changes or performing services connected with relocation of Equipment; or adding or removing accessories, attachments or other devices. For specifics on all maintenance services see Customer Engineering section.

#### **INSTALLATION CHARGE**

There is no installation charge for initial installation of system (s). For add-on equipment or upgrades, that are not designated customer-installable there is an installation charge of 3% of the purchase price - minimum charge \$100 per order.

#### **ADD-ON INSTALLATION CHARGE**

If the customer elects to install the following items without assistance from customer engineering the add-on installation charge does not apply: FT-1, BFT-1/2/3, OP-124



HPS/OIS AND VS/VP ORDERS

TRAINING

Wang will provide, at no charge, a complete word processing Training Learners Package with each system ordered. This learners package is a self-teaching instructional package designed to train each operator completely.

ON-SITE SUPPORT CHARGES - \$60.00 an hour for analyst services

Fee-based services are offered to our customers on an as available basis for an hourly charge.

ADDITIONAL REQUIREMENTS:

This rate does not cover training. (See Training Charges)

This rate does not include travel expenses outside of the service support area. Wang Support charges its travel expenses (airfare, car mileage, hotel and meal costs, etc.) to customers whose locations are beyond a 50 mile radius from their nearest Wang Support Office. These charges are applicable for fee-based services only. The support representative's hourly rate during travel time is not fee-based during the execution of Entitled Support Services responsibilities. However, for fee-based services performed beyond the 50 mile radius, the Support Representatives hourly rate during travel is fee-based. (Management discretion may be used in splitting portal-to-portal expenses between two or more customers when they are beyond the 50 mile radius and are visited in the same day.)

The minimum amount of on-site consultation is one hour.

TRAINING CHARGES - \$125.00 for a half day (up to 4 hours) training class per attendee  
\$175.00 for a full day (up to 8 hours) training class per attendee

Additional training classes (beyond those Entitled Support Services) may be requested by the customer and provided on a resource available basis. Classes may be delivered at the customer site or a Wang site whichever is more appropriate. Classes are measured in days.

At a customer site this rate is based on a minimum of ten students attending the class.

If the customer alters the class lesson plan to suit their specific needs, the preparation time will be chargeable at the then current hourly rate.

This rate does not include travel expenses outside of the service support area. Wang Support charges its travel expenses (airfare, car mileage, hotel and meal costs, etc.) to customers whose locations are beyond a 50 mile radius from their nearest Wang Support Office. These charges are applicable for fee-based services only. The support representative's hourly rate during travel time is not fee-based during the execution of Entitled Support Services responsibilities. However, for fee-based services performed beyond the 50 mile radius, the Support Representatives hourly rate during travel is fee-based. (Management discretion may be used in splitting portal-to-portal expenses between two or more customers when they are beyond the 50 mile radius and are visited in the same day.)

The minimum class length is 1/2 day.

MACHINE ACCESS - \$30.00 per hour (wall clock time)

If the customer wishes to purchase access time on local Wang office equipment beyond their Entitled Support Services hours they may do so on an as available basis for an hourly rate.

ADDITIONAL REQUIREMENTS:

All access to equipment at the Wang office is on a shared basis. In other words the customer may not have exclusive use of the system.

Machine time will be offered on whatever VS or 2200 system is available at the local office.

## OVERVIEW OF WANG SUPPORT SERVICES

The purpose of this section of the Pricing Manual is to provide employees of Wang with a clear and consistent statement of Company Support Policies and Procedures. Support, for the purposes of this section, is defined as responsibilities of the field technical support organization, exclusive of support provided by Customer Engineering.

### CATEGORIES OF SUPPORT

This section clearly defines two categories of Wang Support:

1. Entitled Support Services, which accompany the direct acquisition of the product from Wang, are carefully designed to fully utilize both the resources of Wang and the customer to insure a successful installation of the Wang product. The following are examples of entitled services:

- Installation Planning
- Consultation
- Education
- Shared access to Wang systems
- Telephone support
- Reference documentation

2. Fee-Based Services, provided on an as available basis for a charge, may be offered to our customers in addition to entitled support. Examples of fee-based services are:

- Additional Application Training
- Additional technical consultation
- Additional operator training
- Applications development assistance

Common sense and good business judgement are paramount in determining billable vs. non-billable activities. Field management should use their discretion to determine into which category specific support services fall. In addition, field management should make the decision on whether to offer fee-based services based on the availability of their own resources.

### ADDITIONAL RESOURCES

The purpose of the Technical Support Policy Manual is to provide employees of Wang with a clear consistent statement of policy. It is company confidential. This manual and the policies contained in it reference many support elements, both entitled and fee-based. It refers to documentation, education, seminars, and programs which are available to our customers. It describes certain customer responsibilities and procedures on a product by product basis. And it defines specific entitled hours and training delivered by Wang Support.

Much of this information needs to be communicated directly to customers and much of the detail changes as new programs are developed and introduced. There are a variety of support marketing tools and publications available to assist you in communicating the components and value of this support to your customers and prospects. Therefore in addition to using this policy manual you should refer to these other publications for the following types of information:

#### Support Resources Listing - 14-2763B

This is a tool designed for Wang Support and Sales personnel. It outlines the appropriate support resources for pre and post installation segments of the support cycle. It provides general descriptions of the contents of each customer and analyst resource for all products.

#### Corporate Publications Literature Catalog - 700-5294C

This catalog will be provided to customers as well as Wang Support and Sales personnel. It will include a listing of all training and reference documentation with descriptions of each. Entitled items will be noted. Also prices and ordering information will be included.

#### Support Services/Product Support Brochures

These are available for you to provide to our customers. They contain general overviews of entitled support and fee-based services. They also contain product specific support and descriptions of Wang and customer responsibilities as they apply to each product.

#### Wang Supplies Catalog - 700-5725B

This catalog is provided to customers and lists all supplies available from Wang manufactured to Wang's machine specifications.

### ENTITLED SUPPORT SERVICES SUMMARY FORM

A "picture" of this form is included for each appropriate product in the Pricing Manual as part of each product section. The corresponding Entitled Support Services Summary form is a four-part form which must be ordered separately. These forms have space allocated for a customer acknowledgement signature. It is the Sales Representative's responsibility to secure this signature, provide the customer with a copy, attach a copy to the order, and provide the Branch with a copy. The Branch Administrator sends the fourth copy to the District Entitlement Coordinator; District Entitlement Coordinator sends a copy to the Area; Area sends a copy to the Finance Supervisor.

## POLICY CLARIFICATIONS

**90 DAYS.** All entitled support, including training and on-site consultation, is to be accomplished within 90 days from installation. If the situation warrants however, special arrangements may be made between the customer and Wang Support at the time of implementation planning to extend this period to 180 days. For example, a phased installation may be appropriate to meet special customer needs, there may be problems in getting reservations in classes within the time frame, the customer may not plan to implement certain advanced functions until the basic system is up and running. In all cases if any deviation from the 90 day policy is required it is important to document it at the planning stages of the installation and place it in the customer file.

**CONSULTATION, On-Site.** is measured by hour from the time the Support Representative meets at the customer site with the designated customer contact until the Support Representative leaves the customer site. The minimum amount of on-site consultation is one hour (see Pricing Manual for current rate). After the initial hour, time may be charged in quarter hour increments (see CSSA form).

**CONSULTATION, On-Site Additional.** beyond policy-stated entitled hours are chargeable at the then current hourly rate. However, there will be no additional charge if the Support Manager determines that additional analyst resources are necessary to fulfill the obligation.

**CREDITS and/or SWAPPING** of Entitled Support Services are not permitted. Customers who do not use all their entitled hours, due to in-house training programs and/or internal support staffing, may use their Entitled Support Services, within the parameters defined by each Policy. However, these customers are not permitted to receive a "refund" for unused Entitled Support Services, nor are they allowed to "swap" such services.

**DISKETTE RECOVERY:** Wang Support is always expected to make a reasonable business attempt to recover data at Wang's current billable rates.

**ENTITLED HOURS** defined in Summary are maximum hours. Entitled Support is fulfilled when the customer is satisfied and no longer requires Wang Support even though entitled hours remain.

**INSTALLATION:** Wang Support is not always involved in the installation of the Wang Product. When Customer Engineering is primarily responsible for the installation of the product, loading of software, and verification of proper system generation, Customer Support's primary function is to insure customer satisfaction. When the customer is entitled to on-site consultation at installation time, Customer Support is required to be present to verify proper system generation.

**PROCEDURES, Sequence of** the activities listed as Pre-Sales, Pre-Installation, Installation, and Post-Installation are recommended to occur in the order described in each product's Procedures. Exceptions to this sequence may occur.

**TECHNICAL CONSULTATION** does not include programming or detailed applications design; nor does it include modification or debugging of customer or third party developed programs and software.

**TRAINING/EDUCATION** classes are measured in "hours". The minimum charge for a training class (if not entitled) is four (4) hours (see Pricing Manual for current rate). All hours are preceded by an "up to" statement, since classroom hours may vary due to the different instructor techniques or the level of expertise of the customers in the class.

**TRAVEL, beyond 50 mile radius of nearest Wang Support Office.** Wang Support charges its travel expenses (airfare, car mileage, hotel and meal costs, etc.) to customers whose locations are beyond a 50 mile radius from their nearest Wang Support Office. Such charges are applicable for both entitled and fee-based support services.

The Support Representative's hourly rate during travel time is not chargeable during the execution of entitled responsibilities. However, for fee-based services performed beyond the 50 mile radius, the Support Representative's hourly rate during travel time is chargeable.

Management discretion may be used in splitting portal-to-portal expenses between two or more customers when they are beyond the 50 mile radius and are visited in the same day.

**UPGRADE POLICY:** The Entitled Support Services Summaries for Upgrades/Exchanges for both Office Systems and Computer Systems are contained within their respective sections. The Entitled Support Services Summaries for Upgrades/Exchanges are as follows:

Office Systems: Word Processing Systems  
Word Processing and Office Information Systems  
Office Information Systems and Alliance Systems  
Tempest Word Processing and Office Information System  
Tempest Office Information Systems and Alliance  
Computer Systems: VS Systems

Trade-ins across some products lines (for example, Wangwriter to OIS or OIS to VS) will result in the full entitled support services of the upgrade product line. All trade-ins not appearing on one of the four Entitled Support Services Summaries for Upgrades/Exchanges will be granted the full entitled support services.

## ROLES & RESPONSIBILITIES

### WANG

Branch, District and Area Support Personnel - Field support personnel have the responsibility to carry out these policies and procedures to insure successful customer installations. All support personnel play a role in the implementation of policy. They assist sales in communicating it to customers. They coordinate it with Customer Engineering. They deliver the support and training where specified. They coordinate support and training when delivered elsewhere or by other Wang personnel. They monitor its success. They maintain appropriate files and follow necessary administrative procedures along with sales and administrative personnel. And, they make recommendations for modifications and improvements to policy.

Field Management Personnel - The Area Director along with the Area Support Manager are directly responsible for the successful implementation, control and monitoring of these policies and procedures. However, in many cases it may be recommendable to delegate the authority to make decisions on issues outside of these policies and procedures to the District Manager and District Support Manager jointly. If for sound business reasons an exception is to be made to a policy, that decision should be documented and signed by both parties for auditing purposes.

The wording "Field Management" contained throughout this manual refers to the Area Director and Area Support Manager or in the case where authority over these policies and procedures has been delegated, the District Manager and District Support Manager.

### CUSTOMER

1. Overall Success of Installation. The customer is responsible for insuring the overall success of the installation. The customer's major responsibilities include the execution of defined Policy responsibilities and the implementation of prudent management techniques to insure effective use of the Wang system.
2. Back-up. The customer is responsible for insuring that system recovery and back-up methodologies are established and followed. Wang will not be held responsible for the loss of customer data.

### OEM'S (SYSTEM HOUSES & SOFTWARE) COMPANIES

Wang offers a variety of third party programs to System Houses which allow them to sell Wang products directly to their own customer base. These programs are designed so that the System House assumes the cost of sales and support for that customer base. Hence, Entitlement (which encompasses a variety of support services) does not apply directly to OEM's or their customers.

In addition, the customer of the System House has access to Wang fee-based services on an as available basis if they want further support beyond what the System House offers them i.e., training, consulting.

GEN INFO

WANG

COMPANY CONFIDENTIAL

## CUSTOMER ENGINEERING SUPPORT SERVICES

### Introduction

Wang Customer Engineering is committed to providing its customers with high quality, progressive service. This commitment is demonstrated by the wide variety of service options offered by Wang to enhance customer satisfaction with Wang products.

The Customer Engineering section of the Wang Corporate Pricing Manual provides a consolidated source of information which identifies and explains the current Customer Engineering service options, policies, and pricing. Inquiries or recommendations concerning Wang's service offerings should be discussed with local Customer Engineering management.

The C.E. Support Services policies are also available in the C.E. Policy and Procedures Manual and the C.E. Support Services Reference Guide. If discrepancies should occur due to differences in publication dates, the C.E. Policy and Procedures manual will prevail.

### Index

Description	Page
<b>Section I - Installation Services/Policies</b>	
A. Site Preparation . . . . .	2
B. Installation . . . . .	2
C. Add-On Installations . . . . .	2
D. Conversions/Upgrades-Travel Charges . . . . .	2
E. Warranty . . . . .	3
<b>Section II - Maintenance Contract Services/Policies</b>	
A. Maintenance Service . . . . .	4
B. Maintenance Plans . . . . .	4
C. Extended Service Coverage . . . . .	5
Extended Service Availability Summary . . . . .	6
D. Distance Surcharges . . . . .	7
E. Priority Service Call Program . . . . .	7
F. WangCare Guaranteed Uptime Program . . . . .	8
G. Billing Cycle . . . . .	9
H. Late Payment Charges . . . . .	9
I. Discounts . . . . .	9
J. Multi Year Contracts . . . . .	10
K. Pre-Contract Inspection . . . . .	10
L. Maintenance For Special Products . . . . .	11
M. N/A Minimum System Configuration . . . . .	11
<b>Section III - Per-Call Service/Policies</b>	
A. Standard Service Labor Rates . . . . .	12
B. Minimum Service Call Rates . . . . .	12
C. Per-Call Central Billing Procedures . . . . .	12
D. Service Call Charges (Nonautomobile Travel) . . . . .	12
E. Subassembly Replacement . . . . .	12
F. Warranty . . . . .	12
G. Terms and Discounts . . . . .	12
H. General Notes . . . . .	13
<b>Section IV - Miscellaneous Services and Policies</b>	
A. Standby After-Hours Service Program . . . . .	14
B. On-Site/Dedicated On-Site Personnel . . . . .	14
C. Redundant Equipment . . . . .	15
D. Use of Non-Wang Supplied Devices with Wang Equipment . . . . .	15
E. Use of Non-Wang Supplies with Wang Equipment . . . . .	16
F. Wang Holidays . . . . .	17
G. Mileage Policy . . . . .	17
H. Wang Supplies and Services . . . . .	17
I. State and Local Government Contract Policy . . . . .	17

TIANG

COMPANY CONFIDENTIAL



Section I. INSTALLATION SERVICES/POLICIES

A. Site Preparation:

Wang will provide the customer with a Site Planning Guide (Document #700-59780) which contains all site preparation information and specifications.

The customer is responsible for providing a suitably prepared site. Appropriate power and proper receptacles are particularly important.

Qualified personnel from the installing Branch Service Office will be available to assist the customer in developing their site. Branch Sales Office personnel have a Sales Field Support Manual indicating the expected pre-installation sales support activities by product line and will also be available for assistance.

Prior to system installation, the prepared site must be made available to Wang Customer Engineering for inspection, during which a Site Check List must be completed and signed by both the customer and the attending Wang Customer Engineer. Customer Engineering is not involved with entitlements and customer inquiries should be directed to the Product Line/Sales Support organizations.

Charges - There is no charge for this service when the customer site is located within 100 miles of a Wang Service Center. When the customer site is located beyond 100 miles from a Wang Service Center, the customer will be charged a travel charge of one hour at the Standard Service Labor Rate per 25 mile increment beyond the standard service area.

B. Installation:

Systems delivered within a Wang Laboratories, Inc. Service Area will be installed by a company representative, except for those products previously designated as customer installable.

The installation will include setup, inspection and diagnostic checks.

Cable installation will be considered the responsibility of the customer unless otherwise agreed to by Wang and indicated on the Sales Agreement.

Charges - There are no installation charges for initial installation of systems within 100 miles of a Wang Service Center.

When equipment installations are beyond 100 miles from a Wang Service Center, the customer will be charged an additional one hour (Service Labor Rate) travel charge per 25 mile increment beyond the standard service area. This travel charge will be invoiced by Customer Engineering.

Note: After-Hours Installations will be charged at the prevailing Charge Call Billing rates.

C. Add-on Installations:

For add-on equipment (orders that do not include a CPU or Master, i.e., a workable system), there is an installation charge for both rental and purchased equipment. The add-on equipment installation charge is three percent (3%) of the purchase price, or a minimum \$100 charge per location(s) of installation, whichever is higher. The add-on equipment installation charge will be billed on the sales order for the equipment.

When equipment installations are beyond 100 miles from the Wang Service Center, the customer will be charged an additional one hour travel charge (Standard Service Labor Rate) per 25-mile increment beyond the standard service area. This travel charge will be invoiced by Customer Engineering.

D. Conversions/Upgrades - Travel Charges:

For all conversions/upgrades there is an installation charge for both rental and purchased equipment. The installation charge is three percent (3%) of the purchase price or a minimum \$100 charge per order, for installations within the standard service area of 100 miles from a Wang Service Office.

An additional one hour (service labor rate) travel charge per 25 miles is added to all installation calls beyond the standard service area. This travel charge is invoiced by Customer Engineering.



E. Warranty:

1. Computer and Word Processing

Wang Laboratories, Inc. warrants that all hardware products manufactured by it shall be free from defects in materials and workmanship for a period of 90 days from date of installation for Wang installed hardware, and ninety (90) days from the date of Delivery (F.O.B. Wang's Plant) for Customer installed hardware. In the event a defect in materials or workmanship is discovered and reported to Wang within the said 90 day period, Wang will, at its option, repair the defect or replace the defective product; Wang's obligation hereunder will be limited to such repair or replacement. If the equipment is in a remote location from a Wang Service Center, the Purchaser will pay Wang a travel charge for such repair or replacement (See Section I E, item 2 Travel Charge).

The foregoing responsibilities for Wang shall apply only if its products are used in accordance with Wang Laboratories, Inc. instruction manuals and recognized standards of care, and may be modified only in writing by a document signed by an officer of Wang Laboratories, Inc.

Other than as set forth above, WANG LABORATORIES, INC. MAKES NO WARRANTIES REGARDING ITS PRODUCTS (INCLUDING WITHOUT LIMITATION WARRANTIES AS TO MERCHANTABILITY AND FITNESS FOR A PARTICULAR PURPOSE), EITHER EXPRESSED OR IMPLIED. WANG LABORATORIES, INC. SPECIFICALLY MAKES NO WARRANTIES AS TO THE SUITABILITY OF THE PRODUCTS FOR ANY PARTICULAR APPLICATION, WHETHER FOR BUYER OR ITS CUSTOMERS, AND BUYER AGREES THAT ITS CHOICE OF SO-CALLED "SOFTWARE" WILL BE AN INSTRUMENTAL FACTOR IN THE OUTPUT OF THE PRODUCTS FOR PURPOSES AND USE INTENDED BY BUYER.

IN NO EVENT SHALL WANG LABORATORIES, INC. BE LIABLE FOR SPECIAL INCIDENTAL OR CONSEQUENTIAL DAMAGES IN CONNECTION WITH OR ARISING OUT OF THE FURNISHING, PERFORMANCE OR USE OF ANY PRODUCT COVERED BY THIS AGREEMENT.

RESPONSIBILITY AND/OR LIABILITY OF WANG LABORATORIES, INC. SHALL, IN CONNECTION WITH A WARRANTED PRODUCT, BE LIMITED IN MAXIMUM AMOUNT TO THE ORIGINAL PURCHASE PRICE OF THAT PRODUCT.

2. Travel Charge-Warranty Service

Single Terminal WP/Remote Terminals, (excluding Wangwriter) - Beyond 50 miles of Wang Service Center.

System Site - Beyond 100 miles of Wang Service Center.

Travel charges: For service calls during warranty, the customer will be charged a one hour travel charge (Standard Service Labor Rate) per 25-mile increment beyond the service area indicated above. This charge will be invoiced by Customer Engineering.

3. Software Warranty

Software is warranted to substantially conform to Wang specifications. Wang's sole obligation hereunder shall be to remedy any such nonconformance of the Software when reported to Wang by Customer.

Note: Software warranty inquiries received by Customer Engineering will be forwarded to the appropriate Marketing/Software Development group.

4. Rental Warranty

Wang warrants that Rental Hardware will be in good working order on the day of installation. Wang further warrants that the Rental Hardware and Wang supported Rental Software will conform to Wang's published specifications for the initial rental term and any rental renewals.

Wang will make repairs and replace parts as necessary to maintain the Rental Hardware. Such repair or parts replacement shall be the extent of Wang's Rental Hardware warranty obligation. Wang will correct confirmed nonconformance of Wang supported Rental Software. Correction of nonconformance shall be the extent of Wang's Rental Software warranty obligation. Wang does not warrant that the operation of Wang Hardware or Software will be uninterrupted or error free.

If Rental Hardware and Software is converted to purchase within 90 days of the initial rental commencement date, warranty service shall be provided by Wang in accordance with Wang's Sales Agreement warranty terms. Such warranty service will continue through the ninetieth day after delivery, or the ninetieth day after installation if the Hardware was installed by Wang.

In the event Rental Hardware and Software is converted to purchase beyond the ninetieth day after installation, Wang will have no further warranty responsibility. Continuing maintenance service will be available in accordance with the terms and conditions of the service offering selected by the customer and accepted by Wang.

Section II. MAINTENANCE CONTRACT SERVICES/POLICIES

A. Maintenance Service

Wang agrees to provide maintenance service availability, with a Wang approved Maintenance Contract, during Wang's normal business hours and keep the equipment in good working order while operated in accordance with Wang's published specifications. The maintenance service provided is based on the specific performance standard needs of individual products as determined by Wang. The needs include preventive maintenance and the frequency of such maintenance, procedure and replacement parts. On-call remedial maintenance will be provided and will include adjustments, lubrication and replacement of parts deemed necessary by Wang.

Maintenance Contract service coverage does not include customer requested Deinstallation or Reinstallation of equipment. For services requested which are not covered by a Maintenance Contract, standard Per-Call service charges will apply.

B. Maintenance Plans

1. Plan A. - On-Site Service

On-Site Maintenance: During the Principal Period of Maintenance (8 a.m. - 5 p.m., Monday - Friday, excluding holidays), all service calls necessitated by equipment malfunction will be performed at the customer's location. Reference C.E. Policy regarding minimum system eligibility requirements for Plan A maintenance.

Plan A. provides:

- a) Preventive Maintenance: P.M. service is provided based upon the specific performance standard needs of individual products as determined by Wang Laboratories, Inc.
- b) Replacement Parts: All unserviceable component parts and subassemblies will be replaced at no additional cost, when necessary, due to normal equipment failure. Replaced parts become the property of Wang Laboratories, Inc.
- c) Engineering Changes: All required ECM's, including parts, will be incorporated into Maintenance Contract Customers' equipment at no added cost.
- d) Priority Service Response: This feature is available exclusively through the maintenance agreement program.

Charges - Reference the Wang Corporate Pricing Manual. Maintenance prices for models not listed in the Pricing Manual may be obtained by contacting the C.E. Area Contracts Group.

- Notes:
1. Maintenance charges for Alaska are subject to a ten percent (10%) surcharge, which is added after Extended Coverage and Distance Surcharges, if any, are applied.
  2. Reference the Wang Sales Agreement/Rental Agreement for specific Maintenance Contract Terms and Conditions.

2. Plan B. - Service Center Maintenance.

Plan B. provides:

- a) Service Labor - Service Labor will be provided at the Wang Service Center at no additional charge during the Principal Period of Maintenance.
- b) Replacement Parts - All unserviceable component parts and subassemblies will be replaced at no additional cost, when necessary, due to normal equipment failure. Replaced parts become the property of Wang Laboratories, Inc.
- c) Preventive Maintenance - P.M. Service will be provided at the Wang Service Center based upon the specific performance needs of individual products as determined by Wang Laboratories, Inc.
- d) Engineering Changes - All required ECM's, including parts, will be incorporated at the Wang Service Center into all Plan B customers' equipment at no additional cost.

Charges - 40% less than Standard Maintenance Contract Price. The delivery and pickup of all units, to and from a Wang Service Center, remains the responsibility of the customer.

C. Extended Service Coverage  
 (Section C-5 indicates specific locations with full system extended coverage availability)

1. Customer-Owned Equipment

Extended maintenance service coverage is available at the following surcharge rates for customer-owned equipment. These rates apply before the Distance Surcharges (See Section II D.) are applied.

Customer requests for Hardware Preventive Maintenance outside of the Principal Period of Maintenance may be accommodated at a mutually agreed upon time, Monday thru Friday between the hours of 5 p.m. and 7 p.m.

Computers - OIS - WP

	<u>8 a.m.-5 p.m.</u>	<u>8 a.m.-8 p.m.</u>	<u>8 a.m.-12 p.m.</u>	<u>24 HOURS</u>
Monday thru Friday	0%	15%	25%	35%
Monday thru Saturday	15%	25%	35%	45%
Monday thru Sunday	25%	35%	45%	55%

Percent shown is the increase in basic Maintenance Contract price.

Extended Service Coverage is subject to prior approval by the Area Service Director, and includes the Principal Period of Maintenance (8 a.m. - 5 p.m., Monday through Friday, excluding holidays).

Notes: 1. No extended shift service coverage is available for single terminal WP systems, Wangwriter, and Remote Terminal Maintenance Contracts.

2. Extended service coverage excludes service coverage on holidays. When approved by the C.E. Area Director, holiday service coverage is only available as After Hours (Sunday and Holiday) Standby Coverage. (See Section-IV A.)

2. Rentals

Rental charges cover system use for one operator shift per day, five days per week (40 hours). Extended shift maintenance coverage is available at the following rates. These rates apply before the Distance Surcharges (See Section II D.) are applied.

Computers - OIS - WP

	<u>8 a.m.-5 p.m.</u>	<u>8 a.m.-8 p.m.</u>	<u>8 a.m.-12 p.m.</u>	<u>24 HOURS</u>
Monday thru Friday	0%	9%	18%	36%
Monday thru Saturday	5%	13%	22%	44%
Monday thru Sunday	8%	17%	28%	52%

Percent shown is the percentage increase in the rental price.

Extended Service Coverage for rental equipment is subject to prior approval by the Area Service Director, and includes the Principal Period of Maintenance (8 a.m. - 5 p.m., Monday through Friday, excluding holidays).

Notes: 1. No extended shift service coverage is available for single terminal WP systems, Wangwriter, and Remote Terminal Maintenance Contracts.

2. Extended service coverage excludes service coverage on holidays. When approved by the C.E. Area Director, holiday service coverage is only available as After Hours (Sunday and Holiday) Standby Coverage. (See Section IV A.)

3. Extended P.P.M. - Software Update and Preventive Maintenance Service

Software update and Preventive Maintenance service, as specified by product, is available after, but contiguous to, the Principal Period of Maintenance, Monday through Friday, excluding holidays. Service will normally be performed between 5 p.m. and 8 p.m. and the Branch Manager should attempt to coordinate this service to start at or as near to the end of the P.P.M. as practical.

This service offering is only available to Extended Service Coverage customers. The charge for this service will be added to the Extended Service Coverage surcharge.

Charges: Customer-Owned Equipment - 10% of Maintenance Contract Rate  
Rental Equipment - 4% of Monthly Rental Rate

4. Partial System Extended Coverage

For customers who use less than their full system outside the PPH, Wang offers partial system extended coverage. Partial system extended coverage requires that a minimum of the core system be covered under extended coverage at the applicable surcharge rates.

A Core System is defined as the following Wang supplied units: the system CPU, power supply, all memory and memory controllers, all input/output processors, the master control workstation(s) and the disk device(s) required for the Wang operating system software.

Partial System Extended Coverage will only be available for systems which are covered by a standard Wang Maintenance or Rental Agreement during the PPM. All contracts for Partial System Extended Coverage require the prior approval of the Area Service Director.

5. Extended Coverage Location Summary

The Location Summary indicates the extended service coverage which is available throughout the week from specific Wang service locations. The following information defines the items used within the Summary:

M-F = Monday through Friday  
X = Available

1 = 8 Hr. Coverage, 8 AM - 5 PM  
2 = 16 Hr. Coverage, 8 AM - 12 PM  
3 = 24 Hr. Coverage

Area/City	M	F	Saturday	Sunday
	1	2	1	2
<b>NORTHEAST</b>				
Boston MA	X	X	X	X
Burlington MA	X	X	X	X
Providence RI	X	X	X	X
Manchester NH	X	X	X	X
Farmington CT	X	X	X	X
Stamford CT	X	X	X	X
Rochester NY	X	X	X	X
Albany NY	X	X	X	X
Buffalo NY	X	X	X	X
<b>ATLANTIC (1)</b>				
New York City	X	X	X	X
Rosefield NJ	X	X	X	X
Philadelphia PA	X	X	X	X
<b>SOUTHEAST</b>				
Birmingham AL	X	X	X	X
Tampa FL	X	X	X	X
Orlando FL	X	X	X	X
Atlanta GA	X	X	X	X
Memphis TN	X	X	X	X
Houston TX	X	X	X	X
Washington DC	X	X	X	X
Baltimore MD	X	X	X	X
Charlotte NC	X	X	X	X
Raleigh NC	X	X	X	X
<b>CENTRAL</b>				
Southfield MI	X	X	X	X
Grand Rapids MI	X	X	X	X
Pittsburgh PA	X	X	X	X
Louisville KY	X	X	X	X
Minneapolis MN	X	X	X	X
Houston TX	X	X	X	X
Indianapolis IN	X	X	X	X
Arden OH	X	X	X	X
Cleveland OH	X	X	X	X

Area/City	M	F	Saturday	Sunday
	1	2	1	2
<b>GENERAL (cont'd)</b>				
Columbus OH	X	X	X	X
Cincinnati OH	X	X	X	X
Chicago IL	X	X	X	X
Paris Ridge IL	X	X	X	X
<b>MID-AMERICA</b>				
Dallas TX	X	X	X	X
Fort Worth TX	X	X	X	X
Tulsa OK	X	X	X	X
Oakham City	X	X	X	X
Wrensapolis MO	X	X	X	X
Omaha NE	X	X	X	X
St. Louis MO	X	X	X	X
Houston TX	X	X	X	X
Galveston TX	X	X	X	X
New Orleans LA	X	X	X	X
San Antonio TX	X	X	X	X
Austin TX	X	X	X	X
Dayton OH	X	X	X	X
Westminster CO	X	X	X	X
Des Moines IA	X	X	X	X
<b>MEXICO</b>				
Seattle WA	X	X	X	X
Tacoma WA	X	X	X	X
Portland OR	X	X	X	X
San Francisco	X	X	X	X
Santa Clara CA	X	X	X	X
Los Angeles (2)	X	X	X	X
Orange County	X	X	X	X
San Diego CA	X	X	X	X
Sacramento CA	X	X	X	X
Phoenix AZ	X	X	X	X
Salt Lake City	X	X	X	X

(1) Atlantic Area cities shown are District Service Offices, all Service Centers in the Atlantic Area provide 24 x 7 Extended Coverage availability.

(2) The Ventura Branch Office of the Los Angeles District does not provide Extended Coverage availability.

CUSTOMER  
ENGINEERING

D. Distance Surcharges

1. Customer-Owned Equipment

a) WPS 20/25/30, OIS, COMPUTERS, and WANGWRITER

Distance Surcharge

Between 101-150 miles	50% of maintenance price
Over 150 miles	50% plus an additional 15% of the base maintenance price per each 25 miles over 150 miles.

b) SYSTEM 5 and REMOTE TERMINAL MAINTENANCE CONTRACTS

Distance Surcharge:

Between 51-100 miles	50% of maintenance price
Between 101-150 miles	100% of maintenance price
Over 150 miles	100% plus an additional 15% of the base maintenance price per each 25 miles over 150 miles.

2. Rentals

The following surcharges apply based on the distance from a Wang Service Office:

Distance Surcharge:

Between 51-100 Miles (System 5/Remote Terminals Only)	10% of rental price
Between 101-150 Miles (All Products)	15% of rental price
Over 150 Miles (All Products)	15% plus an additional 5% of rental price for each 25-mile increment over 150 miles.

Note: When applicable, Distance Surcharge rates are applied after Extended Service Coverage Surcharges have been applied.

E. Priority Service Call Program

Upon receipt of a service call by Wang, all Wang customers will be provided service response priority based on the type of service contracted for from Wang.

Classifications of response times are determined by and limited to the resources available to provide adequate support to all Maintenance Contract customers.

1. Response Time - 50 Miles or Less

On a best effort basis, Wang service personnel will respond to Maintenance Contract customers within an average of four (4) hours (Principal Period of Maintenance) to customer locations within 50 miles of a Wang Service Center.

2. Response Time - Over 50 Miles

Maintenance Contract customers located beyond 50 miles of a Wang Service Center will receive an additional response time of two (2) hours average response time for each additional 50 mile increment.

3. Priority of Response

The Call Response System will be based on the priority of Wang customers as follows:

a) Priority 1

Maintenance Contract, Rental and Warranty Customers.

b) Priority 2

Demonstration Equipment on loan for customer evaluation or available for customer demonstration.

c) Priority 3

Per Call customers (Time and Materials) and all other customers without a Maintenance Contract.

d) Priority 4

Preventive Maintenance and ECN service calls.

F. WangCare Guaranteed Uptime Program

Wang has implemented two Guaranteed Uptime maintenance programs: WangCare Guarantee and WangCare Plus. Specific terms, conditions and definitions are detailed in the WangCare Guaranteed Uptime Program Agreement (Form 12g).

1. Eligibility

System Types

- VS, OIS, and 2200 LVP/C, MVP/C, SVP

Customers

- New and existing customers with Wang Maintenance, Rental or Lease Agreements which provide on-site contract service.

Core System Units

- CPU, Memory, Power Supply, I/O Controllers, the required System Disk and console workstation.

2. Requirements

- WangCare Guaranteed Uptime Program Agreement

- Eligible system supported by Wang contract service

- Customer site within Guaranteed Uptime service area

3. WangCare Guarantee is the standard Guaranteed Uptime service offering. It guarantees 95% uptime for each element of the Core System and provides an average response time of four hours or less to customers within 50 miles of a Wang Service Center. (A five hour average response time is provided between 51 and 100 miles.)

Additional Charges - NONE.

Uptime Guarantee - If a Core System Unit does not meet 95% uptime during one calendar month, the customer will receive top priority status. If the problem continues for a second month, Wang will replace the unit at no charge to the customer.

Distance Limitations - Customer site within 100 miles of any Wang Service Center.

4. WangCare Plus is the premium Guaranteed Uptime service offering. It guarantees 98% uptime (99% with one or more shifts of Extended Coverage) for both individual Core System Units and the Core System as a whole. A two hour response time is guaranteed for customer sites within 25 miles of the 100 designated WangCare Plus Service Centers; three hour response is guaranteed within 50 miles.

Optional Core System Units - All additional System Disk Drives.

Additional Charge - 25% of the Core System Unit Maintenance Agreement list prices after adding any Extended Coverage premiums which may apply.

Uptime Guarantee - Same as WangCare Guarantee, but guarantees a 98% to 99% level of uptime; PLUS maintenance credits if system uptimes or Wang's response times fail to meet guaranteed performance levels.

Distance Limitations - Customer site within 50 miles of a designated WangCare Plus Service Center. On an exception basis, Wang may accept requests for WangCare Plus at locations 51 to 100 miles from a designated WangCare Plus Service Center.

**G. Billing Cycle**

Maintenance Contracts will be invoiced on an annual basis if charges are less than \$200 per month or \$2400 per year. However, Wang will honor customers' requests for monthly billing.

Normal billing will occur on a monthly basis.

Minimum Contracts accepted:

Plan	Amount	Time Period
A	\$250.00	Per year or fraction thereof.
B	\$100.00	Per year or fraction thereof.

**H. Late Payment Charges**

Should a customer fail to pay any maintenance charges when due and payable, Wang Laboratories, Inc. reserves the right to levy a late payment charge of 1.5% per month, but not in excess of the lawful maximum, on the unpaid balance. If the charges remain unpaid, the customer will be charged the cost and expense of collection, including reasonable attorney's fees, not to exceed 25% of the amount due. Wang Laboratories, Inc. reserves the right to discontinue service if charges remain unpaid for ninety (90) days.

**I. Discounts**

Wang offers only three (3) authorized discounts to customers as follows:

Annual Volume Maintenance Discount Per Location

- "Location" defined** A Customer "location" is defined as a compact geographic area such as an office building, an office or industrial park, or a complex of adjoining facilities, so that travel time from any part of the location to any other part is minimal. A "location" might be three or four square miles outside of an urban center, but limited to a single office building in a urban area.
- Multiple locations and separate discounts possible** A Customer could have more than one location eligible for maintenance discounts, each with its own revenue level and associated discount. The Wang District Service Manager must approve any aggregation of installations as a "location".
- District Service Manager approval required** A Customer may, as of June 1, 1982 or thereafter, request that a group of system installations be included in a single location for discount purposes. Such a request must be approved in writing by the Wang District Service Manager.
- Retroactive discounts only** All discounts are credited at the end of the year; discounts are not taken during the year. Customer agrees to adhere to Wang's published payment terms for maintenance service. Failure of Customer to pay any charges when due shall constitute sufficient cause for Wang to withhold discounts under this Annual Volume Maintenance Schedule.
- Discount Limitations** The volume discount per location applies to services provided under Wang Maintenance Agreements and Customer Engineering Per-Call Services provided at the defined Customer location. No maintenance discounts will apply to maintenance invoices discounted under any existing maintenance discount (National Select Account) agreement.

**Discount Table** The annual maintenance revenue levels and associated discounts are:

Annual Maintenance Revenue Level by Location	Discount	Annual Maintenance Revenue Level by Location	Discount
\$100,000	5%	\$400,000	11%
\$125,000	6%	\$550,000	12%
\$150,000	7%	\$700,000	13%
\$175,000	8%	\$850,000	14%
\$200,000	9%	\$1,000,000 and over	15%
\$250,000	10%		



Call Screening/Central Site Support Discount

**Call Screening/  
Central Site  
Offerings** Call Screening is the process by which all customer remote system users access a customer-operated Central Site Call Screening Center for qualified analytical and/or technical assistance in problem determination and/or resolution, including immediate telephone resolution if possible.

Central Site Software Support is the process by which the customer provides centralized visibility, control and administration as to the on-going status of Wang and customer software within the customer's network.

**Requirements for  
Qualifications** The customer must support at least fifty (50) multi-site remote system installations of Wang 2200, Wang OIS or Wang VS, singularly or in combinations. The MSO Business Management Department will review for qualification, customers supporting from twenty-five (25) to forty-nine (49) remote system installations.

The customer must submit a support plan which clearly identifies their Call Center, configuration, staffing, procedures and measurement for the Central Site Program which must be approved by the Regional MSO-C.E. Field Operations Vice-President.

An "Annual Amendment for Central Call Screening and Central Site Software Support" must be signed by the customer to be submitted with the customer support plan for approval. The annual "Amendment" will be available from the Area Technical Operations Manager, Area Service Director or the MSO Business Management Department (H/S 14B3B).

**Central Site  
Discount Schedule** Wang will provide the applicable discounts on hardware services and software support including telecommunications set forth below to the customer during the term, for so long as the customer maintains ninety-five per cent (95%) effectiveness in Call Screening and Software Support. Effectiveness is measured by dividing the number of calls received by Wang which is caused by equipment provided by Wang, by the total number of calls received by Wang.

	VS	OIS	2200
Call Screening with T/C	7.5%	7.5%	7.5%
Call Screening without T/C	5.5%	5.5%	5.5%
Software Support	7.5%	7.5%	7.5%
Maximum Discount Allowed	15%	15%	10%

**Discount  
Limitations** Wang's Call Screening/Central Site Support Discount applies only to Maintenance Agreement charges, excluding additional charges for WangCare Plus, Extended Coverage, Distance Surcharges, etc. If a customer site qualifies for both the Annual Volume Maintenance Discount Per Location and the Call Screening/Central Site Support Discount, the customer may select the one discount program to apply at that site, but may not combine these two discount programs.

Prepayment Maintenance Discount

**Prepayment  
discount elements** For payment of annual maintenance billing within 30 days of the start of the annual maintenance term, Wang will grant a discount of six (6%) percent. The six (6%) percent maintenance prepayment discount is applicable to the net Maintenance Agreement invoice amount before taxes.

**J. Multi Year Contracts** Customer Engineering will quote charges for multi-year contracts. Contact the C.E. Business Planning Department when a customer quote is required.

**K. Precontract Inspection** For systems or equipment not presently under Wang's warranty, Wang Customer Engineering requires an Initial Inspection to be performed as a precondition to entering into a Maintenance Agreement. Wang service personnel shall provide an Inspection cost estimate to the customer.

If, as a result of the Initial Inspection, Wang service personnel determine that repairs are required in order to place the equipment in good operating condition, a repair estimate will be provided. With customer approval Wang will place the equipment in good operating condition, including making repairs, adjustments and replacing parts. This also is a chargeable call and the customer will be billed for labor, materials and travel at the prevailing Per-Call Service Rates. Equipment burn-in periods will not be required following inspection or repairs.

Coverage for equipment added to existing agreements will commence when the C.E. Area Contracts Group processes the Maintenance Agreement Amendment. Coverage for systems under a new agreement will commence when the customer's credit status has been verified and the Maintenance Agreement has been authorized at Wang's Home Office.



L. Maintenance for Special Products

1. Maintenance for Special Products - General

Special products require service procedures which are considerably different than those for standard products. For this reason, all special products must have a maintenance contract at the time of purchase. NO ORDERS WILL BE ACCEPTED WITHOUT A MAINTENANCE CONTRACT.

2. Special Products - Service

Because of the nature of Special Products, the stocking of spare parts, service consignments and service training are handled differently than standard products. As a result, no response time commitments can be quoted.

Every effort will be made to repair a Special Product as soon as possible in the field. However, in some instances it may be necessary to return the Special Product to the Home Office for repair. Customers should be advised accordingly.

M. M/A Minimum System Configuration

Wang's ability to effectively and efficiently service Wang hardware is dependent on applying unique diagnostic programs, services and techniques to the hardware system, and then evaluating the resultant system response.

Wang Maintenance Contract Service eligibility is contingent upon an acceptable minimum Wang System configuration. If a Customer's system configuration does not meet Wang's minimum system configuration requirements, maintenance service will be available on a time and materials basis to Per-Call Customers.

The following products are required for Wang's minimum system configuration requirements for on-site maintenance contract service:

- . Central Processing Unit
- . System Disk Drive
- . Master-Console Workstation
- . Printer (excluding 2200 Product Line)

Exceptions to minimum system configuration requirements are as follows:

- . 2200 systems without a printer
- . Wang Professional Computer
- . Wang PCS II Product Line
- . Wang Sales orders for add-on peripherals without Central Processing Unit.
- . Wang Sales orders for system expansion e.g. Central Processing Unit only.
- . Wang approved Software/System House Dealers exempted from minimum system configuration requirements due to technical considerations. Wang Customer Engineering Business Planning Department will maintain a listing of approved Software/System House Dealer exemptions.

Note: Complete details concerning the Minimum System Configuration Policy are contained in C.E. Policy 3.13.

CUSTOMER  
ENGINEERING

Section III PER-CALL SERVICE

In addition to Maintenance Contract Service, Time and Material Service on Wang equipment is available on a Per-Call basis either at the customer site or at Wang Service Centers.

A. Standard Service Labor Rates

Labor On-site or Shop	\$100 per hour
After 5 p.m. and Saturday	\$150 per hour
Sundays and Holidays	\$200 per hour

B. Minimum Service Call Rates

At Wang's Shop - 1 hour minimum	\$100 minimum
0 to 50 miles - 2 hours minimum	\$200 minimum
51 to 100 miles - 4 hours minimum	\$400 minimum
Over 101 miles - 6 hours minimum	\$600 minimum

C. Per-Call Central Billing Procedures

Travel hours for Per-Call customers are invoiced at a flat rate for the average round trip travel time to the site. Except when public transportation is required, Travel Billing is based on the one way distance from the supporting Service Center to the Customer site (determined from DHS/AMS customer records). Travel Billing will be invoiced at the applicable Standard Service Labor Rate as follows:

<u>DHS/AMS TRAVEL MILES</u>	<u>HOURS OF TRAVEL BILLING</u>
0 - 10	0.5
11 - 25	1.0
26 - 50	2.0
51 - 75	3.0
76 or more	4.0

On-site time and Travel Billing hours are added together and compared to the Minimum Service Call hours above. In addition to materials replaced or exchanged, Customers will be invoiced for the On-site hours plus the Travel Billing hours, or the Minimum Service Call hours, whichever is greater.

D. Service Call Charges (Nonautomobile Travel)

For any service calls which are beyond reasonable automobile travel and involve public transportation (airplane, train, etc.), the applicable hourly Standard Service Labor Rate will be charged portal-to-portal to include the on-site labor. The cost of the public transportation will also be charged to the customer.

E. Subassembly Replacement

A charge for the exchange of repairable subassemblies will be made at the current replacement rate.\* This charge is in addition to the normal service rates for travel and labor.

\* For current replacement rate refer to C.E. Field Price Catalog.

F. WARRANTY

All repair labor, including adjustments, will be warranted for ten (10) calendar days from the date of repair.

All new or exchange electronic/mechanical parts or assemblies will be fully warranted for thirty (30) days.

G. Terms and Discounts

Payment terms are Net thirty (30) days. Discounts are not available.

H. General Notes

1. Labor charges will be invoiced in minimum half hour increments.
2. Add 10% to Per Call Service hourly rates for Alaska.
3. When Per-Call Service requires more than one call (or day) to complete, customers are billed for all on-site time. However, Travel Billing applies only once per completed call.
4. Customers with partial Maintenance Agreement coverage, who request service on both Maintenance Agreement and Per-Call Service units, are invoiced as follows:  
  
M/A Unit - No Per-Call charge unless services are not covered under M/A or services are requested outside contract hours.  
  
Non-M/A Unit - Full Travel Billing, on-site time and parts charges, subject to minimum charges, as though no Maintenance Agreement service were involved.
5. Any repairs done at a Wang Service Center are based on Standard Service Labor Rates, plus any defective subassembly exchange rate charges. Parts will be charged at Wang's replacement parts price in effect at the time of repair.
6. When repairs are to be performed at a Wang Service Center, shipping charges to and from the Wang Service Center will be the responsibility of the customer.
7. Questions pertaining to Per-Call Central Billing procedures should be referred to the C.E. Area Finance and Administration Manager.

WANG

COMPANY CONFIDENTIAL

CUSTOMER  
ENGINEERING

Section IV Miscellaneous Services/Policies

A. Standby After-Hours Service Program

Standby repair service may be required by some Wang customers for job operations being performed after regular business hours. For this reason, all Wang customers are offered "Standby After-Hours Service" on a per-request basis. This service is not a standard after-hours service offering and will only be provided when a customer gives advance notice to the Wang Service Office concerned and individual location availability approval is given by the Service Manager.

1. Requirements for Service

- a) Request Basis: Standby After-Hours Service will be offered on a Customer Request basis only.
- b) Advance Notification: All customers must give notice of their request for Standby service to a Wang Service Center for specified Standby periods. Customers should attempt to place calls for weekday Standby After-Hours Service before 12 noon on the day prior to service need, to insure the availability of a Wang Customer Engineer.
  1. Weekdays - a twenty-four (24) hour notice prior to request for service.
  2. Saturday, Sunday or Holidays - a five (5) day notice prior to request for service.
- c) Service Area: Customers within 50 miles of a Wang Service Center.

2. Cost of Standby Service

Maintenance Contract and Rental Customers:

5 p.m. to 8 a.m. - \$200 Standby Charge - per 8 hour shift.  
Saturday - \$200 Standby Charge - per 8 hour shift.

Service during Standby - This charge will be added to Standby Charge when Service is needed.

Service During Standby Rate: \$100 per hour travel and labor, portal-to-portal. Labor and travel are to be invoiced in minimum half hour increments.

Per-Call Customers: (District Service Manager approval required)

8 a.m. to 5 p.m. - \$200 Standby Charge.  
5 p.m. to 8 a.m. - \$200 Standby Charge - per 8 hour shift  
Saturday - \$200 Standby Charge - per 8 hour shift

Service during Standby - This charge will be added to Standby Charge when Service is needed.

Service During Standby Rate: Standard Service Labor Rates and policies (Section III) apply at all times.

All Customers: (Area Service Director approval required)

Sundays & Holidays - \$200 Standby Charge - Per 8 hour shift.

Service during Standby - This charge will be added to Standby Charge when Service is needed.

Service During Standby Rate: \$200 per hour travel and labor, portal-to-portal. Minimum 2 hour charge, labor and travel to be invoiced in minimum half hour increments.

B. On Site/Dedicated On-Site Personnel

1. Dedicated On-Site Personnel

Dedicated On-Site Personnel are available to Maintenance Agreement customers of Wang at the customer's request. Requests for Dedicated On-Site Personnel must be made a minimum of 30 days in advance of customer requirements.

Wang service personnel who are "dedicated" to the customer site will service no equipment other than the customer's Wang equipment for which this individual has been dedicated. This C.E. may be utilized for overall support of a customer site where contracted, however, response to service calls remains first priority.

Dedicated On-Site Personnel (continued)

In the event of sickness, vacation, training, etc. of the dedicated Wang Customer Engineer, an alternate Wang Customer Engineer will be made available to the customer. Wang reserves the right of final selection of the Customer Engineer assigned to dedicated service and may periodically change the C.E. assigned to such service.

The charge to a customer for a Dedicated On-Site Customer Engineer is \$4,000 per month for a C.E. on any 8 hour shift, billable in minimum one month increments. This charge is in addition to all other Maintenance Agreement, Rental or Per-Call Service charges applicable to the equipment serviced. Charges for an additional C.E. on the same shift will be quoted by the C.E. Business Planning Department.

2. On-Site Personnel

Wang retains the right to provide a customer with on-site personnel when required, in Wang's opinion, to fulfill contractual agreements to the customers, i.e., response time, effectiveness levels, etc., or when, in Wang's opinion, it is economically feasible for Wang to provide on-site personnel. Any individuals assigned on-site under these criteria are not dedicated to that customer's site, but may be utilized to perform service at other customer locations and Wang is not responsible for providing a replacement in the event of vacation, sickness, training, etc. In addition, Wang may decide at any time to withdraw on-site personnel. There is no charge to the customer for on-site personnel under these criteria. Final approval for placement of on-site Customer Engineering personnel remains with the Area Service Director.

C. Redundant Equipment

In general, there are not any maintenance discounts allowed for customer purchased redundant equipment. On an exception basis only, a discount of 25% from Wang standard Maintenance Agreement list price (for the redundant CPU) may be granted. Additional printers, workstations, discs, and similar units available thru typical customer configurations are not eligible for discounts. Justifications for granting a redundant equipment maintenance discount must be approved, in writing, by the Sales and Customer Engineering District Managers and the C.E. Area Director.

D. Use of Non-Wang Supplied Devices with Wang Equipment

It is the policy of Wang Laboratories to devote its Customer Engineering resources exclusively to the support of Wang supplied equipment and accessories.

Wang Customer Engineering personnel are not trained or authorized to perform any installation, repair or maintenance of devices which were not supplied by Wang Laboratories, Inc.

When a Wang supplied system or product also contains devices, modifications, alterations, attachments or features (including microcode) which were not supplied by Wang, Customer Engineering will perform service on the Wang supplied portions only. If Wang Customer Engineering personnel, in performing required diagnostic and repair support of Wang supplied equipment, determines that interference of this support is caused by non-Wang supplied devices, the customer, at Wang's discretion, will be required to disconnect or remove all such non-Wang supplied devices before Maintenance Agreement, Warranty or Time & Material service is performed.

If Customer Engineering determines that the malfunction reported by the customer is occurring in or is caused solely by such non-Wang supplied devices, Wang will charge the customer for the entire service call at Wang's standard rates for travel, labor, and parts. These charges will be applied whether the customer's equipment is covered under warranty or Wang Maintenance Agreement.

In no event will Wang Customer Engineering personnel provide any technical advice or assistance to non-Wang personnel with respect to any non-Wang supplied device.

Note

- 1) Customer Engineering will bill the customer when necessary through the present Service Call Invoice or Central Invoice Billing method where available.
- 2) Customer Engineering should not convey to the customer that the use of non-Wang supplied devices automatically cancels the customer's maintenance contract.

Use of Non-Wang Supplied Devices with Wang Equipment (continued)

1. Non-Wang Device - Problem Escalation Procedure

If customer related problems should arise due to Wang's service and/or maintenance pricing policies regarding the use of non-Wang supplied devices with Wang equipment, the following Problem Reporting Escalation Process must be implemented. Each level will attempt to tactfully and effectively alleviate the problem before escalating to the next level.

Level 1 Customer Engineer

The Customer Engineer will tactfully accept the customer's problem(s) and effectively report the problem(s) for resolution to Level 2.

Level 2 Branch Service Manager  
District Technical Specialist

The Branch Service Manager and the District Technical Specialist will make every reasonable and prudent effort to report to the Branch Sales Manager an accurate technical assessment of the customer system problem(s).

Level 3 District Service Manager  
District Sales Manager

The District Service and Sales Managers will be responsible when required to provide the necessary administrative/technical assistance to finalize any outstanding problem(s) of the customer.

E. Use of Non-Wang Supplies with Wang Equipment

Wang Laboratories will not accept responsibility for equipment failure and/or damage to equipment caused by supplies purchased by customers from sources other than Wang Laboratories. All supplies provided by Wang Laboratories are produced according to rigid specifications and are subject to strict quality control standards. Because it is impossible for Wang to exercise quality control over the production of supplies from other sources, Wang cannot guarantee the performance of its equipment with these supplies. Therefore, Wang does not approve or recommend non-Wang supplies for use on Wang equipment.

In the event that a service call becomes necessary for Wang equipment which has failed or become damaged due to the use of non-Wang supplies, Wang Laboratories will charge the customer for the service call (travel, labor, and parts) relating to the specific failure caused by the supplies. This policy also applies to customers with equipment under warranty or covered by Wang Maintenance Agreement.

- Note 1) Customer Engineering will bill the customer when necessary through the present Service Call Invoice or Central Invoice Billing method where available.  
2) Customer Engineering should not convey to the customer that the use of non-Wang supplies automatically cancels the customer's maintenance contract.

1) Non-Wang Supplies - Problem Escalation Procedure

If customer related problems should arise regarding Wang's terms for servicing equipment that has malfunctioned or become damaged due to the use of non-Wang supplies, the following Problem Escalation Process must be implemented. Each level will attempt to tactfully and effectively alleviate the problem before escalating to the next level.

Note Wang employees should avoid making extravagant claims regarding Wang supplies and should never disparage the products of another supplier.

Level 1 Customer Engineer

The Customer Engineer will tactfully accept the customer's problem(s) and effectively report the problem(s) for resolution to Level 2

Level 2 Branch Service Manager  
Branch Sales Manager

The Branch Service and Sales Managers will make every reasonable and prudent effort to identify and coordinate possible solution(s) and convey these solution(s) to the customer prior to Level 3 involvement.

Level 3 District Service Manager  
District Sales Manager

The District Service and Sales Managers will be responsible when required to provide the necessary administrative/technical assistance to finalize the outstanding problem(s) of the customer.

F. Wang Holidays - Excluded from Principal Period of Maintenance

It is the policy of Wang Laboratories, Inc. to grant the following ten (10) paid holidays for U.S. operations each year.

- |                               |                          |
|-------------------------------|--------------------------|
| - New Year's Day              | - Labor Day              |
| - Washington's Birthday       | - Columbus Day           |
| - Patriot's Day (Mass. Only)* | - Thanksgiving Day       |
| - Memorial Day                | - Day After Thanksgiving |
| - Independence Day            | - Christmas              |

\* The observance of some holidays may be determined because of state laws or local traditions (e.g. Patriot's Day - MA only). The Area Service Director and/or Director of Field Operations will determine local observance of holidays within the limits of 10 holidays authorized.

G. Mileage Policy - Travel Distance for Service Support/Surcharges

All references to travel distance, as applied to service support price surcharges, will be measured against the shortest driving distance from the supporting Wang Service location to the Customer site. This travel mileage will be indicated on the customer record in the AMS customer file.

H. Wang Supplies & Services

The Wang Supplies Division supports the supplies requirements of Wang products and systems.

The extensive inventory of products sold by the Wang Supplies Division are manufactured to exacting Wang standards and specifications. These supplies assure the high performance, productivity, accuracy and dependability of a Wang system.

To obtain a Wang Supplies catalog (Wang Part # 700-57250), submit a written request to:

Wang Laboratories, Inc.  
Supplies Division  
800 Chelmsford Street  
Lowell, MA 01851

I. State and Local Government Contract Policy

The GSA Schedule is offered to federal government agencies only. State, local and municipal governments must be extended the Basic Ordering Agreement - State and Local Government Contract.

On a case by case basis, consideration will be given to extending the G.S.A. Contract to a state government if the purchasing regulations of the state government mandate the use of a GSA Contract, or potential business warrants extending the GSA Contract to a state government.

All inquiries must be forwarded to:

Wang Laboratories, Inc.  
1 Industrial Avenue  
Lowell, MA 01851  
Attn: Controller of Field Operations  
Mail Stop 1388A

CUSTOMER  
ENGINEERING



COMPANY CONFIDENTIAL

Effective Date: MAY 1, 1984

- Prices and equipment availability subject to change without notice -

SPECIAL PRODUCTS PRICE LIST

TABLE OF CONTENTS

<u>DESCRIPTION</u>	<u>PAGE</u>	<u>EFFECTIVE DATE</u>
SECTION I 2200 SPECIAL PRODUCTS	2	05/01/84
SECTION II 2200 OPTIONS	3	05/01/84
SECTION III WP SPECIAL PRODUCTS	3	05/01/84
SECTION IV VS SPECIAL PRODUCTS	5	05/01/84

NOTE: ALL SPECIAL PRODUCTS ARE SALES ONLY, NO RENTALS. Special Products may contain remanufactured parts. Check with Special Product Group.

**INSTALLATION CHARGES**

There is no installation charge for initial installation of system(s). For add-on equipment or upgrades that are not designated customer-installable there is an installation charge of 3% of the purchase price - minimum charge \$100 per order.

NOTE: All orders for add-ons and upgrade equipment MUST include the work order numbers and serial numbers of the system components involved.

WANG

COMPANY CONFIDENTIAL

MODEL  
NUMBER

DESCRIPTION

PURCHASE  
PRICEMONTHLY  
MAINTENANCE-----MONTHLY RENTAL PRICES-----  
1 YEAR 2 YEAR 3 YEAR 5 YEAR

## SECTION I 2200 SPECIAL PRODUCTS

MODEL NUMBER	DESCRIPTION	PURCHASE PRICE	MONTHLY MAINTENANCE	1 YEAR	2 YEAR	3 YEAR	5 YEAR
9005-2	Punch Controller and Cable only (T/VP/MVP/LVP)	\$ 1,200	\$ 10	N/A	N/A	N/A	N/A
9020-24	24-Hour Time-of-Day Clock for use with 2200 (T/VP/MVP/LVP)	900	6	N/A	N/A	N/A	N/A
9025	Dual Density 800/1600 BPI; 75 IPS 9 Track Tape Drive (T/VP/MVP/LVP) with Controller	19,500	135	N/A	N/A	N/A	N/A
9044	Paper Tape Reader Controller for MVP/LVP	1,200	10	N/A	N/A	N/A	N/A
9048	Extended I/O Chassis for 2200T/VP/MVP/LVP. Adds 7 I/O Slots.	2,300	25	N/A	N/A	N/A	N/A
9049-XY	Keyboard Keylock for 2200/VS/WP/DIS Workstation	300	2	N/A	N/A	N/A	N/A
9049-31	Keyboard Keylock for 2336DE/DW Ergo Workstation	300	2	N/A	N/A	N/A	N/A
9064-1	2336 Ergo DE Emulation of Data Speed 40	4,025	30	N/A	N/A	N/A	N/A
9068	Paper Tape Punch (Facit) for T/VP/MVP/LVP with Controller (Replaces Model 9005)	5,175	48	N/A	N/A	N/A	N/A
9069	Auxilliary (Slave) CRT Monitor Adaptor	60	N/A	N/A	N/A	N/A	N/A
9069-1	Auxilliary (Slave) CRT Monitor Adaptor with Cable (25')	90	N/A	N/A	N/A	N/A	N/A
9069-2	Auxilliary (Slave) CRT Monitor Adaptor with Cable (50')	108	N/A	N/A	N/A	N/A	N/A
9069-3	Auxilliary (Slave) CRT Monitor Adaptor with Cable (75')	120	N/A	N/A	N/A	N/A	N/A
9080	Controller for German Band Printer	840	7	N/A	N/A	N/A	N/A

NOTE: All orders for add-ons and upgrade equipment MUST include the work order numbers and serial numbers of the system components involved.

SP/ 14 - 2

COMPANY CONFIDENTIAL  
REPLACES: 02/01/84  
EFFECTIVE: 05/01/84

SPEC PROD

# SPEC PROD

MODEL NUMBER	DESCRIPTION	PURCHASE PRICE	MONTHLY MAINTENANCE	-----MONTHLY RENTAL PRICES-----				
				1 YEAR	2 YEAR	3 YEAR	5 YEAR	
SECTION II 2200 OPTIONS								
2250	8-Bit Parallel I/O Interface Controller	\$ 480	\$ 3	N/A	N/A	N/A	N/A	
2252A	Scanning Input Interface Controller (BCD 1-10 Digit Parallel)	720	5	N/A	N/A	N/A	N/A	
2254	IEEE-488 Interface Controller	900	5	N/A	N/A	N/A	N/A	
2282	Graphic CRT Only	4,140	19	N/A	N/A	N/A	N/A	
SECTION III WP/OIS SPECIAL PRODUCTS								
9038-A	WP/OIS to Photocomposer Interface for Auto Logic APS-5 or Micro-S (On-line Interface 6 level code)	\$ 6,000	\$ 35	N/A	N/A	N/A	N/A	
9038-B	WP/OIS to Photocomposer Interface for Compugraphic Advantage. (Paper Tape Reader Port Interface)	6,000	35	N/A	N/A	N/A	N/A	
9038-C	WP/OIS to Photocomposer Interface for Compugraphic Unified Composer (On-Line Interface)	6,000	35	N/A	N/A	N/A	N/A	
9038-D	WP/OIS to Photocomposer Interface for Compugraphic Uni-Setter/VideoSetter (Customer must supply C.G. Dataport Mod Kit.)	6,000	35	N/A	N/A	N/A	N/A	
9038-F	WP/OIS to Photocomposer Interface for Compugraphic 8600 (On-Line Interface)	6,000	35	N/A	N/A	N/A	N/A	
9038-LN	WP/OIS to Photocomposer Interface for Linotron 202N (Paper Tape Reader Port Interface)	6,000	35	N/A	N/A	N/A	N/A	
9038-LP	WP/OIS to Photocomposer Interface for Linotron 202 (Paper Tape Reader Port Interface)	6,000	35	N/A	N/A	N/A	N/A	
9038-LT	WP/OIS to Linoterm Typesetter Interface (Paper Tape Reader Port Interface)	6,000	35	N/A	N/A	N/A	N/A	

NOTE: All orders for add-ons and upgrade equipment MUST include the work order numbers and serial numbers of the system components involved.

MODEL NUMBER	DESCRIPTION	PURCHASE PRICE	MONTHLY MAINTENANCE	-----MONTHLY RENTAL PRICES-----			
				1 YEAR	2 YEAR	3 YEAR	5 YEAR
SECTION III WP/OIS SPECIAL PRODUCTS (continued)							
9038-M	WP/OIS to Photocomposer Interface for Merganthaller VIP (Paper Tape Port Interface)	\$ 6,000	\$ 35	N/A	N/A	N/A	N/A
9038-P	WP/OIS to Photocomposer Interface for ITEK (Dymo Graphics) Pace Setter (Customer may need to purchase photocomposer modifications & software from ITEK. Specify pacesetter Model # and kind of processor.)	6,000	35	N/A	N/A	N/A	N/A
9038-T	WP/OIS to OMNI Tech 2000 Typesetter Interface (On-Line Interface)	6,000	35	N/A	N/A	N/A	N/A
9038-V	WP/OIS to Photocomposer Interface for AM Varityper VOI (5504) and Comp Set (500-3500) AM 508 & Comp Set (500-4510) (PTR Port Interface)	6,000	35	N/A	N/A	N/A	N/A
9049-14	Ergo II Keyboard Keylock	300	2	N/A	N/A	N/A	N/A
9065	Serial IOP Interface for GE 'Terminet' Printer (VS/OIS)	2,990	26	N/A	N/A	N/A	N/A
9067	Paper Tape Punch (Facit) with PIO Interface	6,800	62	N/A	N/A	N/A	N/A
9512-01	Scientific CRT Prom for (secondary) for Three Board Workstations	180	N/A	N/A	N/A	N/A	N/A
9512-02	Scientific CRT Prom for (secondary) for Two Board/Archiving Workstations	180	N/A	N/A	N/A	N/A	N/A
9072	Legal Character Band, 96 Character "C" Style (S, X, O, P) Replacing (C, D, A, W) for 5574 Band Printer	1,440	N/A	N/A	N/A	N/A	N/A
9072-1	Legal Character Band, 96 Character "B/C" Style (S, G, O, P) Replacing (C, D, A, W) 5573 Band Printer	1,440	N/A	N/A	N/A	N/A	N/A

NOTE: All orders for add-ons and upgrade equipment MUST include the work order numbers and serial numbers of the system components involved.



# SPEC PROD

MODEL NUMBER	DESCRIPTION	PURCHASE PRICE	MONTHLY MAINTENANCE	-----MONTHLY RENTAL PRICES-----			
				1 YEAR	2 YEAR	3 YEAR	5 YEAR
SECTION III WP/OIS SPECIAL PRODUCTS (continued)							
PTP-3	Paper Tape Punch (Facit) (8 Level Teletype RS232C/CCITT24 Compatible)	\$ 5,720	\$ 52	N/A	N/A	N/A	N/A
PTP-3-OP	Code Translation Board (Teletype Data Input to Telex Output 5 Level)	1,045	10	N/A	N/A	N/A	N/A
SECTION IV VS 80/100 SPECIAL PRODUCTS							
9057-VS1	Interface to APG Cash Drawer for 2246S (two board) Workstation	\$ 1,800	\$ 13	N/A	N/A	N/A	N/A
9074	Serial IOP Interface for Printronix Printer (Model P300) (WP/OIS/VS)	3,000	26	N/A	N/A	N/A	N/A
NOTE: After the upgrade, maintenance price will be for Serial Printers for the following:							
9075-V2	2263V-2 Upgrade to 5570	3,450	185	N/A	N/A	N/A	N/A
9075-V3	2263V-3 Upgrade to 5571	3,450	203	N/A	N/A	N/A	N/A
9082	Barcode Reader (Intermac) Interface for 2246S (two board) Workstation. Hardware Only.	600	13	N/A	N/A	N/A	N/A
9082-1	Software for Bar Code Reader Interface (one per CPU installation)	1,200	N/A	N/A	N/A	N/A	N/A
9085	Printer Product Printer/Cash Drawer Model S400T Infr. to VS 2246S W/S (Hardware only)	600	13	N/A	N/A	N/A	N/A
9085-1	Software for S.P. Model #9085 (One per CPU installation)	1,800	N/A	N/A	N/A	N/A	N/A
9088	Serial IOP Interface to Qume Sprint 5 RO Printer with Parallel Interface	3,450	30	N/A	N/A	N/A	N/A
9094	Tape Drive Switch	2,300	20	N/A	N/A	N/A	N/A
9095	Disk Switch	2,300	20	N/A	N/A	N/A	N/A

NOTE: All orders for add-ons and upgrade equipment MUST include the work order numbers and serial numbers of the system components involved.

COMPANY CONFIDENTIAL

Effective Date: MAY 1, 1984

- Prices and equipment availability subject to change without notice-

TRADITIONAL RENTAL PRICE LIST

TABLE OF CONTENTS

<u>DESCRIPTION</u>	<u>PAGE</u>	<u>EFFECTIVE DATE</u>
WANGWRITER	2	05/01/84
WP	2	05/01/84
DIS	3	05/01/84
2200	9	05/01/84
VS	12	05/01/84
7500T	15	05/01/84
OVX	15	05/01/84

NOTE: TRADITIONAL RENTAL PRODUCTS ARE FOR RENTAL RENEWAL ONLY

NOTE: All orders for add-ons and upgrade equipment MUST include the work order numbers and serial numbers of the system components involved.

TRE/ 15 - 1

COMPANY CONFIDENTIAL  
REPLACES: 02/01/84  
EFFECTIVE: 05/01/84

TRE

WANG

COMPANY CONFIDENTIAL



MODEL NUMBER	DESCRIPTION	PURCHASE PRICE	MONTHLY MAINTENANCE	MONTHLY RENTAL PRICES			
				1 YEAR	2 YEAR	3 YEAR	5 YEAR
<u>WANGWRITER</u>							
5503	Wangwriter includes work-station with movable keyboard, printer console with mini-diskette and 20 CPS Daisy wheel printer	N/A	N/A	\$ 384	\$ 320	N/A	N/A
5503A	Wangwriter with 96K Memory and mindiskette	N/A	N/A	301	295	282	256
5503D	Wangwriter with 96K Memory and dual diskettes	N/A	N/A	353	345	330	300
5504S	Wangwriter with 128K Memory and mindiskette	N/A	N/A	311	304	291	264
5504D	Wangwriter with 128K Memory and dual diskettes	N/A	N/A	362	355	339	308
5524S	Wangwriter II with 128K Memory and single mindiskette	N/A	N/A	311	304	291	264
TC-5524S	Wangwriter II with 128K Memory and dual mindiskette with TC	N/A	N/A	353	346	331	300
<u>HP</u>							
5505-2	HP System 5 Model II Master, Dual Diskettes and 5506-2 Workstation with Horizontal Scroll	N/A	N/A	\$ 372	\$ 364	\$ 348	\$ 316
5505-3	HP System 5 Model 3 Master, Dual Diskettes and 5506-2 Workstation with Horizontal Scroll, Decision Processing, Auxiliary Functions and Security	N/A	N/A	466	456	436	396
5510A	HP System 10A Master CPU, Dual Diskettes, Workstation (5526) and 35 cps Daisy Wheel Printer (5511)	N/A	N/A	658	644	616	560
5520	HP System 20 Master and Dual Diskette	N/A	N/A	311	221	200	182
5525-1	HP System 25 Model 1 Master CPU/1.25 Megabyte Disk and Single Diskette	N/A	N/A	569	500	464	429
5525-2	HP System 25 Model II Master CPU/2.5 Megabyte Disk and Single Diskette	N/A	N/A	663	555	484	447

NOTE: All orders for add-ons and upgrade equipment MUST include the work order numbers and serial numbers of the system components involved.

TRE/ 15 - 2

COMPANY CONFIDENTIAL  
REPLACES: 02/01/84  
EFFECTIVE: 05/01/84

TRE

MODEL NUMBER	DESCRIPTION	PURCHASE PRICE	MONTHLY MAINTENANCE	-----MONTHLY RENTAL PRICES-----			
				1 YEAR	2 YEAR	3 YEAR	5 YEAR
HP (continued)							
5525-3	HP System 25 Model III Master, 5 Megabyte Disk and Single Diskette	N/A	N/A	\$ 734	\$ 567	\$ 504	\$ 465
5530	HP System 30 Master, 10 Megabyte Disk and Single Diskette	N/A	N/A	804	590	524	484
DIS							
6505	OIS 105 Master, 3.0 MB Disk and Single Diskette	N/A	N/A	\$ 420	\$ 330	\$ 300	\$ 252
6515-1	OIS 115-1 Master, 4.2 MB Disk and Single Diskette	N/A	N/A	540	450	400	341
6525	OIS 125 Master, 5.0 MB Disk and Single Diskette	N/A	N/A	922	902	865	785
6525A	OIS 125A Master, 5.0 MB Disk and Single Diskette	N/A	N/A	1,000	940	865	785
6530	OIS 130 Master, 10.0 MB Disk and Single Diskette	N/A	N/A	1,063	1,040	995	905
6530A	OIS 130A Master, 10.0 MB Disk and Single Diskette	N/A	N/A	1,150	1,085	995	905
6530B	OIS 130B Master, 10.0 MB, 4.2MB Disks and Single Diskette	N/A	N/A	1,250	1,180	1,085	985
6530C	OIS 130C Master, 10.0 MB, 8.4MB Disks and Single Diskette	N/A	N/A	1,310	1,240	1,135	1,035
6530D	OIS 130D Master, 10.0 MB, 16.0MB Disks and Single Diskette	N/A	N/A	1,360	1,290	1,185	1,085
6530E	OIS 130E Master, 10.0 MB, 32.0MB Disks and Single Diskette	N/A	N/A	1,410	1,340	1,235	1,135
6540-1	OIS 140 Model 1 Master, 26.8 MB Disk and Single Diskette	N/A	N/A	1,363	1,334	1,276	1,160

NOTE: All orders for add-ons and upgrade equipment MUST include the work order numbers and serial numbers of the system components involved.

MODEL NUMBER	DESCRIPTION	PURCHASE PRICE	MONTHLY MAINTENANCE	-----MONTHLY RENTAL PRICES-----			
				1 YEAR	2 YEAR	3 YEAR	5 YEAR
<u>OIS (continued)</u>							
6540-1W	OIS 140 Model 1 Master 26.8MB Disk and Single Diskette with WangNet interface	N/A	N/A	\$ 1,396	\$ 1,367	\$ 1,307	\$ 1,188
6540-2	OIS 140 Model 2 Master, 53.6 MB Disk and Single Diskette	N/A	N/A	1,410	1,380	1,320	1,200
6540-2W	OIS 140 Model 2 Master 53.6MB Disk and Single Diskette with WangNet interface	N/A	N/A	1,443	1,413	1,351	1,228
6545	OIS 145 Master, 275 MB Disk, 10 MB Disk, and Single Diskette	N/A	N/A	2,444	2,392	2,288	2,080
6545W	OIS 145 Master, 275MB Disk, 10MB Disk and Single Diskette with WangNet interface	N/A	N/A	2,477	2,425	2,319	2,108
6560	First Optional 10 MB Disk Drive for OIS 105-1/115-2,3,4/140-1,2,3/145A/Alliance	N/A	N/A	423	414	396	360
6560A	Second Optional 5/10 MB Disk Drive for OIS 125A, 130A, 140 or 145A	N/A	N/A	423	414	396	360
6560B	Optional 5 MB Disk Drive for OIS 125	N/A	N/A	423	414	396	360
6560C	Optional 10 MB Disk Drive for OIS 130	N/A	N/A	423	414	396	360
6580-1	Optional 26.8 MB Disk Drive for OIS 140 Model 1	N/A	N/A	799	782	748	680
6580-2	Optional 53.6 MB Disk Drive for OIS 140 Model 2	N/A	N/A	846	828	792	720
<u>WPS/OIS OUTPUT PERIPHERALS</u>							
PIO-1	Phototypesetting Option-Paper Tape Interface	N/A	N/A	\$ 286	\$ 266	\$ 229	\$ 208
<u>WORKSTATIONS</u>							
5526	CRT/Keyboard Workstation	N/A	N/A	\$ 212	\$ 207	\$ 198	\$ 180
5526H	CRT/Keyboard Workstation With Horizontal Scroll	N/A	N/A	188	184	176	160

NOTE: All orders for add-ons and upgrade equipment MUST include the work order numbers and serial numbers of the system components involved.

MODEL NUMBER	DESCRIPTION	PURCHASE PRICE	MONTHLY MAINTENANCE	-----MONTHLY RENTAL PRICES-----			
				1 YEAR	2 YEAR	3 YEAR	5 YEAR
WORKSTATIONS (continued)							
5536A	CRT/Keyboard Workstation With Horizontal Scroll	N/A	N/A	\$ 188	\$ 184	\$ 176	\$ 160
5536-1	16K CRT/keyboard workstation (WPS ONLY)	N/A	N/A	188	151	144	131
5536-2	32K CRT/keyboard workstation (OIS only)	N/A	N/A	203	163	155	141
5536-3	48K CRT/keyboard workstation (OIS only)	N/A	N/A	217	174	166	151
AHS-1	48K Archiving workstation with standard keyboard	N/A	N/A	278	272	260	236
5836-C4	64K Ergonomic CRT workstation with keyboard for WP/DP application within Remote WangNet	N/A	N/A	286	266	245	224
5846-4	64K Ergonomic CRT workstation with standard keyboard	N/A	N/A	286	266	245	224
5944	64K Ergonomic Audio workstation with standard keyboard (Alliance only)	N/A	N/A	341	317	292	267
5945	64K Ergonomic Audio/Proportional Space workstation with standard keyboard (Alliance only)	N/A	N/A	358	332	306	280
5947	64K Ergonomic Minidiskette Archiving workstation with standard keyboard (5 1/4 inch media) (OIS/Alliance)	N/A	N/A	341	317	292	267
5948	64K Proportional Space Ergonomic workstation with standard keyboard (OIS/Alliance)	N/A	N/A	303	281	259	237
5949	64K Proportional Space Ergonomic Minidiskette Archiving workstation with standard keyboard (OIS/Alliance)	N/A	N/A	358	332	306	280
5200W	Ergonomic workstation	N/A	N/A	250	244	234	212

NOTE: All orders for add-ons and upgrade equipment MUST include the work order numbers and serial numbers of the system components involved.

MODEL NUMBER	DESCRIPTION	PURCHASE PRICE	MONTHLY MAINTENANCE	-----MONTHLY RENTAL PRICES-----			
				1 YEAR	2 YEAR	3 YEAR	5 YEAR
<u>WORKSTATIONS (continued)</u>							
5200W/AUD	Audio workstation (Alliance only)	N/A	N/A	\$ 297	\$ 290	\$ 278	\$ 252
5200W/MINI	Minidiskette Archiving workstation (5 1/4 inch media) (DIS/Alliance)	N/A	N/A	297	290	278	252
5200W/PS	Proportional Space workstation (DIS/Alliance)	N/A	N/A	264	258	247	224
5200W/AUD-PS	Audio/Proportional Space workstation (Alliance only)	N/A	N/A	311	304	291	264
5200W/MINI-PS	Proportional Space/Minidiskette Archiving workstation (DIS/Alliance)	N/A	N/A	311	304	291	264
5200KBD/IIS-STD	Standard keyboard	N/A	N/A	24	23	22	20
5200/TC	TC Option (WPS/DIS only)	N/A	N/A	71	69	66	60
TC-5536-2	32K CRT/keyboard workstation	N/A	N/A	273	197	187	170
TC-5536-3	48K CRT/keyboard workstation	N/A	N/A	287	207	197	179
TC-AWS-1	48K Archiving workstation with standard keyboard	N/A	N/A	348	341	326	296
TC-5846-4	64K Ergonomic CRT workstation with standard keyboard	N/A	N/A	369	342	315	289
TC-5947	64K Ergonomic Minidiskette Archiving workstation with standard keyboard (5 1/4 inch media) (DIS)	N/A	N/A	424	393	362	332
TC-5948	64K TC Proportional Space Ergonomic workstation with standard keyboard (DIS)	N/A	N/A	385	357	329	301
TC-5949	64K TC Proportional Space Ergonomic Minidiskette Archiving workstation with standard keyboard (DIS)	N/A	N/A	440	408	376	344

TYPESETTERS

ON-LINE TYPESETTER

5548Z	TYPESETTER 5548Z	N/A	N/A	\$ 1,040	\$ 964	\$ 832	\$ 756
-------	------------------	-----	-----	----------	--------	--------	--------

NOTE: All orders for add-ons and upgrade equipment MUST include the work order numbers and serial numbers of the system components involved.



MODEL NUMBER	DESCRIPTION	PURCHASE PRICE	MONTHLY MAINTENANCE	MONTHLY RENTAL PRICES				
				1 YEAR	2 YEAR	3 YEAR	5 YEAR	
OFF-LINE TYPESETTER								
48Z	TYPESETTER 48Z	N/A	N/A	\$ 1,040	\$ 964	\$ 832	\$ 756	
PRINTERS								
5581	40 CPS Daisy Wheel Printer	N/A	N/A	\$ 311	\$ 304	\$ 291	\$ 264	
55B1WC	40 CPS Wide Carriage Daisy Printer	N/A	N/A	329	322	308	280	
IP41F	Intelligent Image Printer	N/A	N/A	1,504	1,472	1,408	1,280	
DW/5-20	20 CPS, Bidirectional Daisy Wheel Printer for System 5	N/A	N/A	127	124	119	108	
DW/MP-20	20 CPS, Bidirectional Daisy Wheel Printer for WPS 20/25/30	N/A	N/A	127	124	119	108	
PRINTER OPTIONS								
5538	Twin Sheet Feeder (21/2x11-8 1/2)	N/A	N/A	\$ 94	\$ 92	\$ 88	\$ 80	
EF-31	Envelope Feeder for 5577 Printer. 115 VAC 60hz (U.S. sized business envelopes; #7 3/4, 9, 10)	N/A	N/A	94	92	88	80	
EF-32	Envelope Feeder for 5577 Printer. 220 VAC 50hz (U.S. sized business envelopes; #7 3/4, 9, 10)	N/A	N/A	94	92	88	80	
EF-33	Envelope Feeder for 5577 Printer. 220 VAC 50hz (Int'l sized business envelopes; min. 98.4 x 190.5 mm max. 108 x 222.4 mm)	N/A	N/A	94	92	88	80	
MCR-1	Magnetic Card Reader	N/A	N/A	165	161	154	140	
DATA COMMUNICATIONS OPTIONS								
TC-BWP	WPS External Communications Controller. WPS, MAILWAY <sup>®</sup> , 2780 and 3780 Emulations	N/A	N/A	118	115	110	100	
TC-B	OIS External Telecommunications Controller for OIS Batch (2780/3780, MAILWAY <sup>®</sup> , WPS) Communications	N/A	N/A	132	129	124	112	

NOTE: All orders for add-ons and upgrade equipment MUST include the work order numbers and serial numbers of the system components involved.

MODEL  
NUMBER

DESCRIPTION

PURCHASE  
PRICEMONTHLY  
MAINTENANCE-----M O N T H L Y R E N T A L P R I C E S-----  
1 YEAR            2 YEAR            3 YEAR            5 YEAR

## TC DEVICE

5595-3	Asynch 2741 and TC Channel (5528)	N/A	N/A	\$ 85	\$ 83	\$ 80	\$ 72
--------	--------------------------------------	-----	-----	-------	-------	-------	-------

UPGRADE  
JOB #

DESCRIPTION

PURCHASE  
PRICE-----R E N T A L-----  
SINGLE OR MONTHLY  
CHARGE            1 YEAR

The rental charges listed include any applicable difference in prices.

## UPGRADES

UJ-1041	System 105 to 130A	N/A	\$ 1,000	\$ 100
UJ-1042	System 105 to 130B	N/A	500	50
UJ-1180	System 105-1 to 130A	N/A	1,000	100
UJ-1181	System 105-1 to 130B	N/A	1,000	100
UJ-1044	System 115-1 to 130A	N/A	1,000	100
UJ-1045	System 115-1 to 130B	N/A	500	50
UJ-1046	System 115-2 to 130A	N/A	1,500	150
UJ-1047	System 115-2 to 130C	N/A	500	50
UJ-1188	System 115-3 to 130D	N/A	500	50
UJ-1190	System 115-4 to 130E	N/A	500	50
UJ-1021	System 5-1 to 5-3	N/A	500	50
UJ-2020	System 5-1 to 20 (Upgrade involves an exchange of ser- IALIZED equipment)	N/A	2,000	200
UJ-2023	System 5-1 to 25-3 (Upgrade involves an exchange of ser- IALIZED equipment)	N/A	2,000	200
UJ-2024	System 5-1 to 30 (Upgrade involves an exchange of ser- IALIZED equipment)	N/A	2,000	200
UJ-1022	System 5-2 to 5-3 (Field Upgradable)	N/A	500	50
UJ-2025	System 5-2/5-3 to 20 (Upgrade involves an exchange of ser- IALIZED equipment)	N/A	3,150	315

NOTE: All orders for add-ons and upgrade equipment MUST include the work order numbers and serial numbers of the system components involved.

TRE/ 15 - 8

COMPANY CONFIDENTIAL  
REPLACES: 02/01/84  
EFFECTIVE: 05/01/84

TRE

UPGRADE JOB #	DESCRIPTION	PURCHASE PRICE	-----R E N T A L-----	
			SINGLE CHARGE	OR MONTHLY 1 YEAR

The rental charges listed include any applicable difference in prices.

UPGRADES (continued)

UJ-2028	System 5-2/5-3 to 25-3 (Upgrade involves an exchange of ser- IALIZED equipment	N/A	\$ 3,150	\$ 315
UJ-2029	System 5-2/5-3 to 30 (Upgrade involves an exchange of ser- IALIZED equipment	N/A	3,150	315
UJ-1023	System 10 to 10A (Field Upgradable)	N/A	500	50
UJ-1024	System 10/10A to 20	N/A	500	50
UJ-1027	System 10/10A to 25-3	N/A	500	50
UJ-1028	System 10/10A to 30	N/A	500	50
UJ-1031	System 20 to 25-3	N/A	500	50
UJ-1032	System 20 to 30	N/A	500	50

MODEL NUMBER	DESCRIPTION	PURCHASE PRICE	MONTHLY MAINTENANCE	-----MONTHLY RENTAL PRICES-----			
				1 YEAR	2 YEAR	3 YEAR	5 YEAR
<u>2200</u>							
2200T-4	CPU-16K Memory, 6 I/O Slots (equivalent to T1632)	N/A	N/A	\$ 255	\$ 230	\$ 220	\$ 200
2200T-6	CPU-24K Memory, 6 I/O Slots (equivalent to T832)	N/A	N/A	306	276	264	240
2200T-8	CPU-32K Memory, 6 I/O Slots (equivalent to 2-T1632)	N/A	N/A	357	322	308	280
2209	800 BPI 9-Track Drive with Controller Consists of:	N/A	N/A	531	479	458	416
2226A	12" CRT Console	N/A	N/A	113	102	97	88
2226B	12" CRT Console	N/A	N/A	113	102	97	88
2230MXA-1	Master Daisy Chain Disk Multi- plexer Controller	N/A	N/A	41	37	36	32
2230MXB-1	Slave Daisy Chain Disk Multi- plexer Controller	N/A	N/A	26	23	22	20

NOTE: All orders for add-ons and upgrade equipment MUST include the work order numbers and serial numbers of the system components involved.



MODEL  
NUMBER

DESCRIPTION

PURCHASE  
PRICEMONTHLY  
MAINTENANCE-----MONTHLY RENTAL PRICES-----  
1 YEAR 2 YEAR 3 YEAR 5 YEAR

2200 (continued)

22C13	2260C Series Disk Multiplexing Controller. Necessary to multiplex 2260C Series Disk Drives utilizing the 2230MXA-1 or 2230MXB-1 Multiplexers	N/A	N/A	\$ 51	\$ 46	\$ 44	\$ 40
2260C	5MB-F + 5MB-R Disk Drive with 22C12 Disk Controller and 2297 Stand	N/A	N/A	546	493	471	428
2260C-1/4	1.25 MB-F + 1.25 MB-R Disk Drive with 22C12 Disk Controller and 2297 Stand	N/A	N/A	419	378	361	328
2260C-1/2	2.5 MB-F + 2.5 MB-R Disk Drive with 22C12 Disk Controller and 2297 Stand	N/A	N/A	470	424	405	368
2260C-2	Dual 5MB-F + 5MB-R Disk Drives with 22C12 Disk Controller and 2297 Stand	N/A	N/A	939	847	810	736
2270-1	.25MB Single Removable Diskette Drive Only	N/A	N/A	164	148	141	128
2270-2	.50MB Dual Removable Diskette Drive Only	N/A	N/A	240	217	207	188
2270-3	.75 MB Triple Removable Diskette Drives Only	N/A	N/A	317	286	273	248
2280-1	13.4MB Removable and 13.4MB Fixed Disk Drive (26.8MB Total) with 22C14 Disk Processing Unit	N/A	N/A	969	874	836	760
2280-2	13.4MB Removable and 40.2MB Fixed Disk Drive (53.6MB Total) with 22C14 Disk Processing Unit	N/A	N/A	1,020	920	880	800
2280N-1	13.4MB Removable and 13.4MB Fixed Disk Drive (26.8MB Total) Only	N/A	N/A	867	782	748	680
2280N-2	13.4MB Removable and 40.2MB Fixed Disk Drive (53.6MB Total) Only	N/A	N/A	918	828	792	720
2281	Daisy Output Writer	N/A	N/A	230	207	198	180
2261	High Speed Printer	N/A	N/A	357	322	308	280

NOTE: All orders for add-ons and upgrade equipment MUST include the work order numbers and serial numbers of the system components involved.

TRE/ 15 - 10

COMPANY CONFIDENTIAL  
REPLACES: 02/01/84  
EFFECTIVE: 05/01/84

TRE

TRE

MODEL NUMBER	DESCRIPTION	PURCHASE PRICE	MONTHLY MAINTENANCE	-----MONTHLY RENTAL PRICES-----				
				1 YEAR	2 YEAR	3 YEAR	5 YEAR	
2200 (continued)								
2231W-1	Matrix Printer (112 Col./120 CPS, 10p)	N/A	N/A	\$ 148	\$ 134	\$ 128	\$ 116	
2231W-2	Matrix Printer 132 Col./120 CPS, 12p)	N/A	N/A	164	148	141	128	
2271	Bi-directional Output Writer	N/A	N/A	133	120	115	104	
5570	Serial Line Printer, 600 LPM, without IOP	N/A	N/A	847	764	731	664	
VS								
VS-4S	128KB Main Memory	N/A	N/A	\$ 1,678	\$ 1,514	\$ 1,448	\$ 1,316	
VS-8S	256KB Main Memory	N/A	N/A	1,831	1,652	1,580	1,436	
VS-12S	384KB Main Memory	N/A	N/A	2,137	1,928	1,844	1,676	
VS-16S	512KB Main Memory	N/A	N/A	2,341	2,112	2,020	1,836	
VS-4SA	128KB Main Memory	N/A	N/A	2,142	1,932	1,848	1,680	
VS-8SA	256KB Main Memory	N/A	N/A	2,295	2,070	1,980	1,800	
VS-12SA	384KB Main Memory	N/A	N/A	2,601	2,346	2,244	2,040	
VS-16SA	512KB Main Memory	N/A	N/A	2,805	2,530	2,420	2,200	
VS-8B	256KB Main Memory	N/A	N/A	969	874	760	722	
VS-12B	384KB Main Memory	N/A	N/A	1,275	1,150	1,000	950	
VS-16B	512KB Main Memory	N/A	N/A	1,479	1,334	1,160	1,102	
VS90-1	1024KB Main Memory	N/A	N/A	4,015	3,723	3,212	2,920	
VS90-2	2048KB Main Memory	N/A	N/A	4,565	4,233	3,652	3,320	
VS90-3	3072KB Main Memory	N/A	N/A	5,060	4,692	4,048	3,680	
VS90-4	4096KB Main Memory	N/A	N/A	5,555	5,151	4,444	4,040	
VS-32F	1024KB Main Memory	N/A	N/A	4,565	4,233	3,652	3,320	
VS-64F	2048KB Main Memory	N/A	N/A	5,115	4,743	4,092	3,720	
VS-96F	3072KB Main Memory	N/A	N/A	5,610	5,202	4,488	4,080	
VS-128F	4096KB Main Memory	N/A	N/A	6,105	5,661	4,884	4,440	

NOTE: All orders for add-ons and upgrade equipment MUST include the work order numbers and serial numbers of the system components involved.

MODEL NUMBER	DESCRIPTION	PURCHASE PRICE	MONTHLY MAINTENANCE	-----MONTHLY RENTAL PRICES-----			
				1 YEAR	2 YEAR	3 YEAR	5 YEAR
VS							
VS-160F	5120KB Main Memory	N/A	N/A	\$ 6,545	\$ 6,069	\$ 5,236	\$ 4,760
VS-192F	6144KB Main Memory	N/A	N/A	6,985	6,477	5,588	5,080
VS-224F	7168KB Main Memory	N/A	N/A	7,425	6,885	5,940	5,400
VS-256F	8192KB Main Memory	N/A	N/A	7,865	7,293	6,292	5,720
6554-1A	External TC Processor supporting one telecommunications line, can be located up to 2000' from the master. (Supports AL-3271E, AL-BATCH, AL-TTE)	N/A	N/A	204	184	176	160
6554-2A	External TC Processor supporting two telecommunications line, can be located up to 2000' from the master. (Supports AL-3271E, AL-BATCH, AL-TTE)	N/A	N/A	306	276	264	240
6554-3A	External TC Processor supporting three telecommunications line, can be located up to 2000' from the master. (Supports AL-3271E, AL-BATCH, AL-TTE)	N/A	N/A	408	368	352	320
6554-4A	External TC Processor supporting four telecommunications line, can be located up to 2000' from the master. (Supports AL-3271E, AL-BATCH, AL-TTE)	N/A	N/A	510	460	440	400
VS-8021	.256KB memory, 300KB diskette drive, 16 port serial IOP, 4 port disk IOP, 90MB Fixed/Removable disk	N/A	N/A	N/A	1,656	1,584	1,440
VS-8022	512KB memory, 300KB diskette drive, 16 port serial IOP, 4 port disk IOP, 90MB Fixed/Removable disk	N/A	N/A	N/A	1,840	1,760	1,600
WORKSTATIONS							
2866S-2	VS Ergo 2 32K DP Workstation with DP Keyboard	N/A	N/A	\$ 168	\$ 156	\$ 144	\$ 132
2246R	Remote VS Workstation	N/A	N/A	215	194	185	168
2246S-2B	32K Serial VS Workstation	N/A	N/A	141	127	121	110

NOTE: All orders for add-ons and upgrade equipment MUST include the work order numbers and serial numbers of the system components involved.

TRE/ 15 - 12

COMPANY CONFIDENTIAL  
REPLACES: 02/01/84  
EFFECTIVE: 05/01/84

TRE

TRE

MODEL NUMBER	DESCRIPTION	PURCHASE PRICE	MONTHLY MAINTENANCE	-----MONTHLY RENTAL PRICES-----			
				1 YEAR	2 YEAR	3 YEAR	5 YEAR
WORKSTATIONS (continued)							
2246SKE-2	32K Serial VS Keypress Workstation with 029 Keyboard and Reversed Numeric Keypad	N/A	N/A	\$ 179	\$ 161	\$ 154	\$ 140
2866SKE-2	VS Ergo 2 32K Keypress Workstation with DP Keyboard with 029 Keyboard and Reversed Numeric Keypad	N/A	N/A	209	194	179	164
2866R	Ergonomic Remote VS Workstation.	N/A	N/A	248	230	212	194
2246C	Combined WP/DP 32K VS Workstation	N/A	N/A	220	161	154	141
2866C	Ergonomic Combined WP/DP 32K VS Workstation	N/A	N/A	253	235	217	198
2866C4	Ergonomic Combined WP/DP 64K VS Workstation.	N/A	N/A	286	266	245	224
2964C	64K Audio Ergo 2 Workstation with Combined Standard Keyboard and Numeric Keypad (VS Alliance ONLY)	N/A	N/A	341	317	292	267
5200W/VS	64K Combined Workstation Electronics for DP/WP application with WangNet interface (Peripheral Band)	N/A	N/A	250	244	234	212
5200W/VS-AUD	64K Audio Combined 5300 Series Electronics Package (VS Alliance Only) with WangNet interface (Peripheral Band)	N/A	N/A	297	290	278	252
2266C-1	48K VS-AWS with Combined Keyboard, includes HS Controller. Stores up to 300K Bytes.	N/A	N/A	408	368	352	320
2266C-3	48K VS-AWS with Combined Keyboard, includes both HS and SS Controllers. Stores up to 1.2 megabytes.	N/A	N/A	459	414	396	360
2266S-1	48K VS-AWS with Serial (DP) keyboard, includes HS Controller. Stores up to 300K bytes.	N/A	N/A	408	368	352	320

NOTE: All orders for add-ons and upgrade equipment MUST include the work order numbers and serial numbers of the system components involved.

MODEL NUMBER	DESCRIPTION	PURCHASE PRICE	MONTHLY MAINTENANCE	-----MONTHLY RENTAL PRICES-----			
				1 YEAR	2 YEAR	3 YEAR	5 YEAR
WORKSTATIONS (continued)							
2266S-2	48K VS-AWS with Serial (DP) keyboard, includes SS controller. Stores up to 1.2 megabytes.	N/A	N/A	\$ 408	\$ 368	\$ 352	\$ 320
2266S-3	48K VS-AWS with Serial (DP) keyboard, includes both HS and SS controller. Stores up to 1.2 megabytes.	N/A	N/A	383	345	330	300
2860-1	Ergonomic 48K VS-AWS with Combined keyboard, includes HS controller. Stores up to 300K bytes.	N/A	N/A	457	424	391	357
2860-2	Ergonomic 48K VS-AWS with combined keyboard includes both HS and SS controller. Stores up to 1.2 megabytes.	N/A	N/A	512	475	438	400
2860-3	Ergonomic 48K VS-AWS with Serial (DP) keyboard, includes HS controller. Stores up to 300K bytes.	N/A	N/A	457	424	391	357
2860-4	Ergonomic 48K VS-AWS with Serial (DP) keyboard, includes SS controller. Stores up to 1.2 megabytes.	N/A	N/A	457	424	391	357
2860-5	Ergonomic 48K VS-AWS with Serial (DP) keyboard, includes both HS and SS controller. Stores up to 1.2 megabytes.	N/A	N/A	512	475	438	400
5300/VS-OP	32K DP Workstation	N/A	N/A	88	82	76	69
5300/VS-IIS32	32K Combined Workstation	N/A	N/A	165	153	141	129
UNI/KBD-STD	Universal Low Profile Standard Keyboard (For WangNet Ergos)	N/A	N/A	30	28	24	22
2209V-3	7 Track Tape Drive (800 BPI, 75 IPS, 60KBS without IOP)	N/A	N/A	715	663	572	520
2209V-3B	Magnetic Tape Drive. (7-Track 800 BPI, 75 IPS, 60KB per second) Pre-requisite is a 2209V-3. Used for drive 2 through 4	N/A	N/A	660	612	528	480

NOTE: All orders for add-ons and upgrade equipment MUST include the work order numbers and serial numbers of the system components involved.

TRE/ 15 - 14

COMPANY CONFIDENTIAL  
REPLACES: 02/01/84  
EFFECTIVE: 05/01/84

TRE

MODEL NUMBER	DESCRIPTION	PURCHASE PRICE	MONTHLY MAINTENANCE	-----MONTHLY RENTAL PRICES-----				
				1 YEAR	2 YEAR	3 YEAR	5 YEAR	
CARD READER								
2244V	Card Reader with 250 CPM capacity	N/A	N/A	\$ 357	\$ 322	\$ 308	\$ 280	
<u>7500T</u>								
7536-1T	16K CRT/keyboard workstation	N/A	N/A	\$ 317	\$ 292	\$ 286	\$ 261	
7536-2T	32K CRT/keyboard Workstation	N/A	N/A	324	299	293	267	
TC-7536-2T	32K CRT/keyboard Workstation with horizontal scroll, MPS, 2780, 3780, 2741 and TTY (ASCII) Emulations	N/A	N/A	373	344	336	307	
7581W-1T	35 CPS Daisy Wheel Printer with 64K memory	N/A	N/A	386	378	361	328	
7536-4T	64K CRT/Keyboard Workstation	N/A	N/A	291	263	251	228	
TC-7536-4T	64K CRT/Keyboard Workstation with horizontal scroll, MPS, 2780, 3780 2741, and TTY (ASC II) Emulations	N/A	N/A	329	297	284	258	
DVX HARDWARE								
DVX-1	4 telephone line, 275 MB Digital Voice Exchange	N/A	N/A	\$ 6,811	\$ 4,476	\$ 4,282	\$ 3,892	
DVX-2	4 telephone line, 550 MB Digital Voice Exchange	N/A	N/A	8,421	5,534	5,294	4,812	
DVX-3	4 telephone line, 825 MB Digital Voice Exchange	N/A	N/A	10,031	6,592	6,306	5,732	
DVX-4	8 telephone line, 275 MB Digital Voice Exchange	N/A	N/A	8,211	5,396	5,162	4,692	
DVX-5	8 telephone line, 550 MB Digital Voice Exchange	N/A	N/A	9,821	6,454	6,174	5,612	
DVX-6	8 telephone line, 825 MB Digital Voice Exchange	N/A	N/A	11,431	7,512	7,186	6,532	
DVX-7	8 telephone line, 1100 MB Digital Voice Exchange	N/A	N/A	13,041	8,570	8,198	7,452	

NOTE: All orders for add-ons and upgrade equipment MUST include the work order numbers and serial numbers of the system components involved.

MODEL NUMBER	DESCRIPTION	PURCHASE PRICE	MONTHLY MAINTENANCE	-----M O N T H L Y R E N T A L P R I C E S-----			
				1 YEAR	2 YEAR	3 YEAR	5 YEAR
<u>DVX HARDWARE (continued)</u>							
DVX-8	12 telephone line, 550 MB Digital Voice Exchange	N/A	N/A	\$ 11,221	\$ 7,374	\$ 7,054	\$ 6,412
DVX-9	12 telephone line, 825 MB Digital Voice Exchange	N/A	N/A	12,831	8,432	8,066	7,332
DVX-10	12 telephone line, 1100 MB Digital Voice Exchange	N/A	N/A	14,441	9,490	9,078	8,252
DVX-11	16 telephone line, 825 MB Digital Voice Exchange	N/A	N/A	14,231	9,352	8,946	8,132
DVX-12	16 telephone line, 1100 MB Digital Voice Exchange	N/A	N/A	15,841	10,410	9,958	9,052

MODEL NUMBER	DESCRIPTION	INITIAL LICENSE FEE	MONTHLY LICENSE FEE	-----M O N T H L Y R E N T A L P R I C E S-----			
				1 YEAR	2 YEAR	3 YEAR	5 YEAR
<u>DVX SOFTWARE</u>							
DVXFP 1.0	Voice Messaging Application and Operating System	N/A	N/A	\$ 1,540	\$ 1,012	\$ 968	\$ 880

MODEL NUMBER	DESCRIPTION	PURCHASE PRICE	MONTHLY MAINTENANCE	-----M O N T H L Y R E N T A L P R I C E S-----			
				1 YEAR	2 YEAR	3 YEAR	5 YEAR
<u>DVX OPTION</u>							
DVX/DPTION	4 telephone line cabinet, 6565 275MB Disk Drive, and DVXFP 1.0 Voice Messaging Application Software	N/A	N/A	\$ 3,780	\$ 2,484	\$ 2,376	\$ 2,160

UPGRADE JOB #	DESCRIPTION	PURCHASE PRICE	-----R E N T A L-----	
			SINGLE CHARGE	OR MONTHLY 1 YEAR

The purchase/rental charges listed include any applicable difference in prices. The incremental maintenance charge is also due.

DVX UPGRADES

UJ-1103	DVX-1 to DVX-2	N/A	\$ 1,000	\$ 100
UJ-1104	DVX-1 to DVX-3	N/A	1,000	100
UJ-1105	DVX-1 to DVX-4	N/A	1,000	100

NOTE: All orders for add-ons and upgrade equipment MUST include the work order numbers and serial numbers of the system components involved.

TRE/ 15 - 16

COMPANY CONFIDENTIAL  
REPLACES: 02/01/84  
EFFECTIVE: 05/01/84

UPGRADE JOB #	DESCRIPTION	PURCHASE PRICE	-----R E N T A L-----		
			SINGLE CHARGE	OR	MONTHLY 1 YEAR

The purchase/rental charges listed include any applicable difference in prices. The incremental maintenance charge is also due.

## DVX UPGRADES

UJ-1106	DVX-1 to DVX-5	N/A	\$ 1,000	\$	100
UJ-1107	DVX-1 to DVX-6	N/A	1,000		100
UJ-1108	DVX-1 to DVX-7	N/A	1,000		100
UJ-1109	DVX-1 to DVX-8	N/A	1,000		100
UJ-1110	DVX-1 to DVX-9	N/A	1,000		100
UJ-1111	DVX-1 to DVX-10	N/A	2,000		200
UJ-1112	DVX-1 to DVX-11	N/A	2,000		200
UJ-1113	DVX-1 to DVX-12	N/A	2,000		200
UJ-1114	DVX-2 to DVX-3	N/A	1,000		100
UJ-1116	DVX-2 to DVX-5	N/A	1,000		100
UJ-1117	DVX-2 to DVX-6	N/A	1,000		100
UJ-1118	DVX-2 to DVX-7	N/A	1,000		100
UJ-1119	DVX-2 to DVX-8	N/A	1,000		100
UJ-1120	DVX-2 to DVX-9	N/A	1,000		100
UJ-1121	DVX-2 to DVX-10	N/A	1,000		100
UJ-1122	DVX-2 to DVX-11	N/A	1,000		100
UJ-1123	DVX-2 to DVX-12	N/A	2,000		200
UJ-1124	DVX-3 to DVX-6	N/A	1,000		100
UJ-1125	DVX-3 to DVX-7	N/A	1,000		100
UJ-1126	DVX-3 to DVX-9	N/A	1,000		100
UJ-1127	DVX-3 to DVX-10	N/A	1,000		100
UJ-1128	DVX-3 to DVX-11	N/A	1,000		100
UJ-1129	DVX-3 to DVX-12	N/A	1,000		100

NOTE: All orders for add-ons and upgrade equipment MUST include the work order numbers and serial numbers of the system components involved.



UPGRADE  
JOB #

DESCRIPTION

PURCHASE  
PRICE

-----R E N T A L-----  
SINGLE OR MONTHLY  
CHARGE 1 YEAR

The purchase/rental charges listed include any applicable difference in prices. The incremental maintenance charge is also due.

DVX UPGRADES

UPGRADE JOB #	DESCRIPTION	PURCHASE PRICE	SINGLE CHARGE	OR	MONTHLY 1 YEAR
UJ-1130	DVX-4 to DVX-5	N/A	\$ 1,000	\$	100
UJ-1131	DVX-4 to DVX-6	N/A	1,000		100
UJ-1132	DVX-4 to DVX-7	N/A	1,000		100
UJ-1133	DVX-4 to DVX-8	N/A	1,000		100
UJ-1134	DVX-4 to DVX-9	N/A	1,000		100
UJ-1135	DVX-4 to DVX-10	N/A	1,000		100
UJ-1136	DVX-4 to DVX-11	N/A	1,000		100
UJ-1137	DVX-4 to DVX-12	N/A	2,000		200
UJ-1138	DVX-5 to DVX-6	N/A	1,000		100
UJ-1139	DVX-5 to DVX-7	N/A	1,000		100
UJ-1140	DVX-5 to DVX-8	N/A	1,000		100
UJ-1141	DVX-5 to DVX-9	N/A	1,000		100
UJ-1142	DVX-5 to DVX-10	N/A	1,000		100
UJ-1143	DVX-5 to DVX-11	N/A	1,000		100
UJ-1144	DVX-5 to DVX-12	N/A	1,000		100
UJ-1145	DVX-6 to DVX-7	N/A	1,000		100
UJ-1146	DVX-6 to DVX-9	N/A	1,000		100
UJ-1147	DVX-6 to DVX-10	N/A	1,000		100
UJ-1148	DVX-6 to DVX-11	N/A	1,000		100
UJ-1149	DVX-6 to DVX-12	N/A	1,000		100
UJ-1150	DVX-7 to DVX-10	N/A	1,000		100
UJ-1151	DVX-7 to DVX-12	N/A	1,000		100
UJ-1152	DVX-8 to DVX-9	N/A	1,000		100
UJ-1153	DVX-8 to DVX-10	N/A	1,000		100

NOTE: All orders for add-ons and upgrade equipment MUST include the work order numbers and serial numbers of the system components involved.

TRE/ 15 - 18

COMPANY CONFIDENTIAL  
REPLACES: 02/01/84  
EFFECTIVE: 05/01/84

TRE

TRE

UPGRADE JOB #	DESCRIPTION	PURCHASE PRICE	-----R E N T A L-----	
			SINGLE CHARGE	OR MONTHLY 1 YEAR

The purchase/rental charges listed include any applicable difference in prices. The incremental maintenance charge is also due.

DVX UPGRADES

UJ-1154	DVX-8 to DVX-11	N/A	\$ 1,000	\$ 100
UJ-1155	DVX-8 to DVX-12	N/A	1,000	100
UJ-1156	DVX-9 to DVX-10	N/A	1,000	100
UJ-1157	DVX-9 to DVX-11	N/A	1,000	100
UJ-1158	DVX-9 to DVX-12	N/A	1,000	100
UJ-1159	DVX-10 to DVX-12	N/A	1,000	100
UJ-1160	DVX-11 to DVX-12	N/A	1,000	100

COMPANY CONFIDENTIAL  
MAY 1984

NOTE: All orders for add-ons and upgrade equipment MUST include the work order numbers and serial numbers of the system components involved.

## SIC CODE LISTINGS

## INTRODUCTION

Depicted below are a combination of 2 and 3 digit SIC codes patterned after industry markets. Enter either the 2 or 3 digit code on the work order form based upon the industry classification of the customer at the ship to address.

INDUSTRY	MAJOR GROUP	2 DIGIT CODE	GROUP	3 DIGIT CODE	DESCRIPTION
Finance	Banking	-	Commercial	602	-
		-	Mutual Savings	603	-
		-	Trust Companies	604	-
	Credit Cos.	-	Savings & Loans	612	-
		-	Credit Unions	614	-
		-	Credit Card Cos.	615	-
	Brokerage	-	Mortgage Companies	616	-
		-	Security Brokers	621	Includes Investment Bankers, etc...
		-	Commodity Brokers	622	-
		-	Security/Commodity Exchanges	623	New York Stock Exchange, etc...
	Insurance	Insurance Cos.	63	-	-
Insurance Agents		64	-	-	-
Real Estate		65	-	-	-
Manufacturing & Distribution	Oil and Gas Extraction	13	-	-	-
	Food Products	20	-	-	-
	Tobacco	21	-	-	-
	Textiles	22	-	-	-
	Apparel	23	-	-	-
	Lumber	24	-	-	-
	Furniture	25	-	-	-
	Paper	26	-	-	-
	Printing/Publishing	27	-	-	-
	Chemicals/Pharmaceuticals	28	-	-	-
	Petroleum Refining	29	-	-	-
	Rubber/Plastics	30	-	-	-
	Leather	31	-	-	-
	Stone/Clay/Glass/Concrete	32	-	-	-
	Primary Metal	33	-	-	Steel, etc...
	Fabricated Metal	34	-	-	Cans, Tools, Hardware, etc...
Machinery	35	-	-	Industrial, Farm, Construction, Machinery, et	
Electrical Machinery	36	-	-	Motors, Appliances, Communications, etc...	

WANG

COMPANY CONFIDENTIAL



## SIC CODE LISTINGS

INDUSTRY	MAJOR GROUP	2 DIGIT CODE	GROUP	3 DIGIT CODE	DESCRIPTION	
Manufacturing & Distribution (Cont'd)	Transportation	-	Motor Vehicles	371	-	
		-	Aerospace	372	-	
		-	Ships	373	-	
		-	Railroads	374	-	
		Instruments	38	-	-	Photographic, Medical, Optical, Time, etc...
		Misc. Manufacturing	39	-	-	Jewelry, Musical, Toys, Sporting Goods, etc...
		Wholesale Trade	50	-	-	-
		Retail	53	-	-	-
		Hospitality	70	-	-	Hotels, etc...
	Public Sector	Education	-	Elementary/Secondary Schools	821	-
-			Colleges & Universities	822	-	
-			Libraries	823	-	
-			Vocational	824	-	
-			Misc. Education	829	-	
-			Executive Offices	911	-	
		Government	-	Legislative	912	-
			-	General Government	919	Commissions, etc.
		Judicial	-	Courts	921	-
			-	Public Order	922	Police, Fire, Prisons; District Attorney, etc
		Public Finance	93	-	-	Treasurers Office, Customs, Budgets, Property Tax, etc...
		Human Resource Admin.	-	Education	941	State Education Depts., School Boards, etc.
			-	Public Health	943	-
			-	Social	944	Social Security, Welfare, Unemployment, etc..
		Environmental Admin.	95	-	-	Wildlife, Waste, Housing, Urban Planning, etc
		Economic Admin.	96	-	-	Census, Port Authority, Motor Vehicle Registration, etc...
Professional Services	Legal	81	-	-	-	
	Associations	86	-	-	Associations, Religious Organizations, etc...	
	Accounting/Consulting	89	-	-	-	

SIC CODE LISTINGS

<u>INDUSTRY</u>	<u>MAJOR GROUP</u>	<u>2 DIGIT CODE</u>	<u>GROUP</u>	<u>3 DIGIT CODE</u>	<u>DESCRIPTION</u>
Health Care	Health Services		Physicians	801	-
			Dentists	802	-
			Osteopaths	803	-
			Other Practitioners	804	Psychologists, Chiropractors, Optometrists, Podiatrists, etc...
			Nursing Homes	805	-
			Hospitals	806	-
			Medical Laboratories	807	-
			Outpatient	808	Clinics, Rehab Centers

COMPANY CONFIDENTIAL



Fold

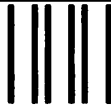

**WANG**

**BUSINESS REPLY CARD**

FIRST CLASS PERMIT NO. 16 LOWELL, MA  
POSTAGE WILL BE PAID BY ADDRESSEE

**Wang Laboratories, Inc.  
Price List Administration  
M/S 1407A  
One Industrial Avenue  
Lowell, MA 01851**

NO POSTAGE  
NECESSARY IF  
MAILED IN THE  
UNITED STATES

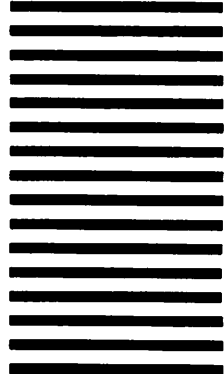

Put along  
fold line.



CONFIDENTIAL

*Wang Laboratories reserves the right to change specifications without prior notice.*

Reproduction of Wang manuals or other Wang documentation is prohibited without the express written consent of an authorized representative of Wang Laboratories, Inc. Charges, if any, will be included in the letter of consent.



WANG LABORATORIES, INC., ONE INDUSTRIAL AVENUE, LOWELL, MA 01851 • TEL 617/459-5000, TWX 710-343-6769, TELEX 94-7421





**WANG**

WANG LABORATORIES, INC., ONE INDUSTRIAL AVENUE, LOWELL, MA 01851 • TEL. 617/459-5000, TWX 710-343-6769, TELEX 94-7421