

**WANG**

**I.A.7.M-1**

**CUSTOMER ENGINEERING**

**PRODUCT MAINTENANCE MANUAL**

**SYSTEMS INSTALLATION GUIDE  
FOR  
VS, 2200, WP/OIS SYSTEMS**

**NOTICE**

THIS DOCUMENT IS THE PROPERTY OF WANG LABORATORIES, INC. INFORMATION CONTAINED HEREIN IS CONSIDERED COMPANY PROPRIETARY INFORMATION AND ITS USE IS RESTRICTED SOLELY TO THE PURPOSE OF ASSISTING YOU IN SERVICING WANG PRODUCTS; REPRODUCTION OF ALL OR ANY PART OF THIS DOCUMENT IS PROHIBITED WITHOUT THE CONSENT OF WANG LABORATORIES.

**MAY 1981**

**REORDER NUMBER  
729-0907**

SYSTEMS INSTALLATION GUIDE

DISCLAIMER OF WARRANTIES  
AND  
LIMITATION OF LIABILITIES

The staff of Wang Laboratories, Inc., has taken due care in preparing this manual; however, nothing contained herein modifies or alters in any way the standard terms and conditions of the WANG purchase agreement, acquired, nor increases in any way WANG's liability to the customer. In no event shall Wang Laboratories, Inc., or its subsidiaries be liable for incidental or consequential damages in connection with or arising from the use of this manual or any programs contained herein.

THIS GUIDE SUPERSEDES ALL PREVIOUS EDITIONS.

SYSTEMS INSTALLATION MANUAL  
TABLE OF CONTENTS

CHAPTER 1 INTRODUCTION

1.1	SCOPE .....	1-1
1.2	PURPOSE .....	1-1
1.3	IMPORTANCE OF SITE PREPARATION .....	1-1
1.4	PREDELIVERY CHECKLISTS .....	1-2
1.5	RELATED DOCUMENTATION .....	1-3

CHAPTER 2 PHYSICAL LAYOUT

2.1	SELECTING A SUITABLE LOCATION .....	2-1
2.2	DESIGNING THE FLOOR PLAN.....	2-1
2.2.1	LAY-OUT CONSIDERATIONS AND PRECAUTIONS .....	2-2
2.3	SITE CONSTRUCTION MATERIALS .....	2-2
2.3.1	FLOORING .....	2-2
2.3.2	FLOOR SEALERS AND FINISHERS .....	2-3
2.3.3	RAISED FLOORING .....	2-4
2.4	CABLING .....	2-6
2.4.1	INTERBUILDING CABLING .....	2-6
2.5	PHYSICAL SPECIFICATIONS OF WANG PROCESSORS .....	2-7

CHAPTER 3 OPERATING ENVIRONMENT

3.1	ENVIRONMENT .....	3-1
3.1.1	TEMPERATURE .....	3-1
3.1.2	HUMIDITY .....	3-3
3.1.3	DIRT AND DUST .....	3-4
3.2	SYSTEM RELIABILITY VERSUS ENVIRONMENT .....	3-5
3.3	MAKING THE ENVIRONMENT SAFE .....	3-6
3.3.1	FIRE PROTECTION .....	3-6
3.3.2	SAFETY PRECAUTIONS .....	3-8
3.4	ENVIRONMENTAL SPECIFICATIONS OF WANG EQUIPMENT .....	3-8

CHAPTER 4 ELECTRICAL REQUIREMENTS

4.1	POWER SOURCE .....	4-1
4.1.1	POWER DISTRIBUTION .....	4-3
4.1.2	PLUGS AND RECEPTACLES .....	4-4
4.1.3	NEMA COLOR CODES .....	4-6
4.1.4	CUSTOMER CONVENIENCE OUTLETS .....	4-6
4.2	IMPORTANCE OF PROPER GROUNDING .....	4-6
4.2.1	GROUND AS OPPOSED TO NEUTRAL (GROUND-NEUTRAL) .....	4-7
4.2.2	INSTALLING AN EARTH GROUND REFERENCE .....	4-8
4.2.3	EARTH GROUND STAKES .....	4-9

4.2.4	EARTH GROUND GRID MESHES .....	4-10
4.2.5	TESTING EARTH GROUND .....	4-11
4.2.6.	GROUNDING A RAISED FLOOR .....	4-12
4.3	WIRING THE SELECTED SITE .....	4-12
4.4	PROBLEMS WITH POWER AND POSSIBLE SOLUTIONS .....	4-14
4.4.1	VOLTAGE REDUCTIONS .....	4-15
4.4.2	POWER FLUCTUATIONS .....	4-16
4.4.3	TRANSIENTS .....	4-17
4.4.4	CORRECTING POWER PROBLEMS .....	4-18
4.5	ELECTRICAL SPECIFICATIONS OF WANG EQUIPMENT .....	4-19

CHAPTER 5 STATIC

5.1	ELECTROSTATIC DISCHARGE .....	5-1
5.2	STATIC RELATED PROBLEMS .....	5-1
5.3	ELIMINATING STATIC PROBLEMS IN THE WORK ENVIRONMENT .....	5-1
5.4	SHIELDING WANG EQUIPMENT .....	5-2
5.4.1	TESTING AND INSTALLING THE VS 60/80 GROUND STRAP .....	5-5
5.5	USE OF THE HYPOT TESTER FOR STATIC TESTING .....	5-7
5.5.1	STATIC TESTING VS SYSTEMS .....	5-8
5.5.1	STATIC TESTING 2200 SYSTEMS .....	5-8
5.5.1	STATIC TESTING WP/OIS SYSTEMS .....	5-9

APPENDICES

APPENDIX A	VS CABLING IDENTIFICATION .....	A-1
APPENDIX B	WORLDWIDE POWER .....	B-1
APPENDIX C	VOLTAGE RANGES .....	C-1
APPENDIX D	PRODUCT INFORMATION SHEETS .....	D-1

LIST OF ILLUSTRATIONS

<u>FIGURE NO.</u>	<u>TITLE</u>	<u>PAGE</u>
1-1	TYPICAL PROCESSING EQUIPMENT LAYOUT .....	1-0
2-1	STATIC POTENTIAL OF COMMON FLOOR COVERINGS .....	2-3
2-2	PEDESTAL-TYPE RAISED FLOORING .....	2-5
3-1	HEAD/DISK RELATIONSHIP TO POSSIBLE CONTAMINANTS .....	3-4
4-1	2-PHASE, 3-WIRE CONNECTION WITH SAFETY GROUND .....	4-1
4-2	3-PHASE, 3-WIRE 2200 VOLT PRIMARY FEEDER .....	4-2
4-3	REPRESENTATIVE GROUND REFERENCE DISTRIBUTION .....	4-4
4-4	NEMA CONFIGURATIONS .....	4-5
4-5	EARTH GROUND STAKE (Ground Rod) .....	4-10
4-6	EARTH GROUND GRID MESH .....	4-10
4-7	MODEL 606-3 (Three Channel) DRANETZ POWER ANALYZER ..	4-13
4-7A	DRANETZ CONNECTIONS .....	4-14
4-8	SAG AND SURGE WAVEFORMS .....	4-17
4-9	IMPULSE WAVEFORMS .....	4-18
5-1	VS 60/80 POWER SUPPLY (Bottom View) .....	5-6

TABLES

TABLE 4A	VOLTAGE RANGES .....	4-16
----------	----------------------	------

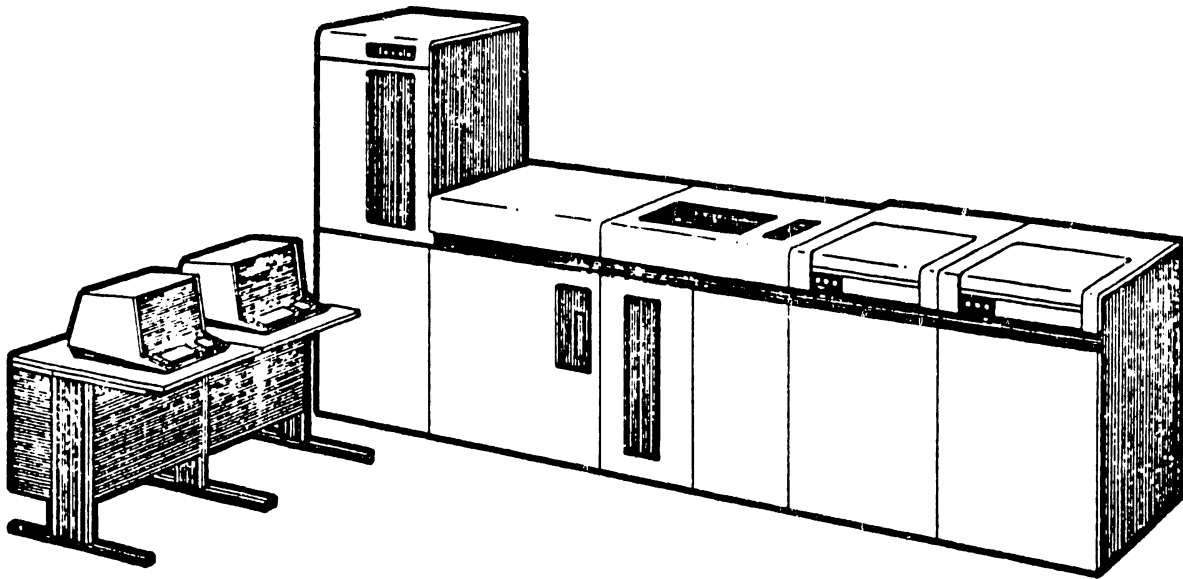

FIGURE 1-1 TYPICAL PROCESSING EQUIPMENT LAYOUT

**CHAPTER**

**1**

**INTRO-  
DUCTION**

## CHAPTER 1 INTRODUCTION

### 1.1 SCOPE

This document contains information relating to the site preparation for, and installation of, 2200, VS, WP, and OIS equipment. The specifications given in this manual are correct as of the date of publication. Any changes, additions, or corrections will be made as addenda to this manual or as separate Product Service Notices (PSN,s) as applicable.

### 1.2 PURPOSE

This manual is designed to assist the Wang Customer Engineer (CE) in preparing the customer site to ensure efficient machine and personnel functioning. It is intended to answer specific questions concerning the electrical, physical, and environmental requirements of most Wang equipment. With careful planning and the proper use of this and other documentation, the system can be installed with little or no interruption of the customer's daily business routine. If problems or questions arise, Wang sales representatives and systems analysts are available for consultation and assistance. It is the responsibility of the CE, however, to actually install the system components.

### 1.3 IMPORTANCE OF SITE PREPARATION

With the increasing complexity in circuit and system design, now more than ever before site preparation is critical to the overall performance of processing equipment. Location, design, and construction of a site, the power source, the environmental control systems, and even the operators, all contribute to the effective operation of a system. From the simplest of peripheral devices to the most complex CPU, without care and planning in the selecting or building of a suitable site, a single device or a full-blown system will not perform up to its maximum potential.

In discussing site preparation, several terms are used to describe certain site locations. A definition of these various terms follows.



1. Computer Room--An isolated room equipped with its own environmental control, power, and grounding systems. The room should be professionally maintained and have restricted entry to limit through traffic. This is the ideal system location.
2. Professional Office--A climate controlled clean area that may be enclosed or partitioned. An isolated power and ground system should be available and through traffic is light to moderate. Cleaning should be done professionally.
3. General Office--Climate or temperature controlled clean area isolated from light manufacturing or assembly work area by walls or partitions. Through traffic is moderate and area has isolated power and grounding.
4. Light Industrial--Open area where light assembly or manufacturing is done. Usually temperature controlled but not dust or humidity controlled. Power source is subject to fluctuations caused by on-line machinery. Area not recommended as system installation site.
5. Heavy Industry--Area subject to high amounts of dust, dirt, and other contaminants. Heavy machinery on-line in the area produces wide voltage fluctuations. Area not recommended for installation of any processing equipment.

#### 1.4 PREDELIVERY CHECKLISTS

Whether installing a single-user Word Processor or a full-blown VS-100 Computer, successful completion of the job requires a planned, coordinated effort involving not only the actual equipment but such related factors as:

- Site location and floor plan.
- Environmental requirements.
- Electrical requirements.
- Cable routing.
- Equipment transportation.

Adhering to the following checklists will ensure minimum disruption of the customer's normal business routine at installation time. Using this checklist as a guide will also ensure that the system is installed properly and that it will function optimally. Other chapters in this manual provide the CE with suggestions and information necessary for meeting installation requirements.

1. TEN WEEKS PRIOR TO DELIVERY
  - a) Have the customer prepare a preliminary installation layout.
  - b) With the preliminary layout completed, review the equipment order with the customer.
  - c) Submit the cable order at this time (if not already done).
  - d) If telecommunications is specified, ensure that the customer has contacted the telephone company or an approved modem vendor to prepare for the installation of all required telephones, modems, and telephones lines.
  
2. SIX WEEKS PRIOR TO DELIVERY
  - a. Plans for the machine room should be complete and approved by both the customer and the Wang representative.
  - b. Review cable requirements, especially for cables routed through conduit, ceilings, floors, or walls.
  - c. Inspect facilities for the installation of sprinkler systems, environmental control equipment, and fire extinguishers.
  - d. Have an electrician inspect the electrical service, wiring, power supply, and power distribution plans.
  - e. Complete all necessary building alterations before delivery. Include space for supplies and Wang customer documentation.
  - f. Check the loading capacity of elevators and the size of halls and doorways to be used to transport the system to the desired site.
  
3. TWO WEEKS PRIOR TO DELIVERY
  - a. Have all planned modifications for wiring, air conditioning, and communication facilities complete and tested. (This should be done no later than one week before system delivery.
  - b. Ensure that all Building alterations are completed at this time.

#### 1.5 RELATED DOCUMENTATION

The following documents contain information pertinent to site preparation and equipment installation.

1. Plant Engineering Handbook, by William Staniar (McGraw Hill)
2. National Electrical Code (NFPA 70\*)

3. Protection of Electronic Computer/Data Processing Equipment (NFPA 75\*)
4. Installation of Air-Conditioning and Ventilation Systems  
(non-residential) (NFPA 90A\*)
5. Recommended Good Practice for the Maintenance and Use of Portable Fire  
Extinguishers (NFPA 10A\*)
6. Installation Protection Code (NFPA 78\*)
7. ASHRAE Handbook, American Society of Heating, Refrigeration, and  
Air-Conditioning Engineers
8. Computer Talk, Vol. 1, No. 1, 3M Company
9. Computer Decisions, Vol. 2, No. 10
10. ANSI Standard X3.11 (1969)
11. U.L. Handbook #478, Underwriters Laboratories, Inc.
12. ISO Recommended R1681 (1970)
13. NBFU #70, National Board of Fire Underwriters
14. EIA Standard RS-232C, Electronics Industries Association
15. VS Referance Summary
16. VS 100 Summary

\* NFPA standards and publications are available from the National Fire  
Protection Association, Batterymarch Park, Quincy, MA 02269.

**CHAPTER**

**2**

**PHYSICAL**

**LAYOUT**

## CHAPTER 2

### PHYSICAL LAYOUT

#### 2.1 SELECTING A SUITABLE LOCATION

Wang equipment is designed to function properly in most normal office environments. Although Wang does not require the use of a dedicated computer room for its equipment, it is recommended for the following reasons:

1. The proper environment is easily maintained.
2. Dedicated power lines, if required, can be more readily accessed.
3. Normal equipment maintenance can be performed with a minimum of customer inconvenience.
4. The CE can access most major system components in the event of an equipment malfunction.
5. Equipment noise is kept to a minimum in surrounding office areas.

For user convenience and maintenance ease, the master processor, disk drives, and printers should be located in a central area, whether a dedicated room or not (see Paragraph 1.3 for a definition of terms). Because locally connected workstations can be installed anywhere up to a maximum of 2000 feet from the master processor, their location is determined by customer needs. In any event, the following points should be considered in selecting any site:

1. Adequate space is provided for all equipment.
2. Adequate space is provided for necessary supplies and documentation.
3. Sufficient space is provided for servicing the equipment.
4. People can readily access, work with, and work around the equipment with minimum inconvenience.
5. Adequate space is provided for future system expansion.
6. Through traffic is kept to a minimum around the CPU and associated disk drives to lessen the risk of accidental damage to equipment.

#### 2.2 DESIGNING THE FLOOR PLAN

In creating a floor plan, the customer should consider the following items:

1. Location of equipment and furniture should be based on user comfort and convenience, as well as ease of access for maintenance.

2. The layout should make efficient use of available space.
3. Storage areas should be convenient to the equipment being supported.
4. The equipment should be located away from high traffic areas.

#### 2.2.1 LAY-OUT CONSIDERATIONS AND PRECAUTIONS

When the customer has finished the equipment layout plan, the CE and other Wang representatives should examine it to ensure that the following provisions have been met.

1. All proposed equipment locations meet Wang space requirements.
2. The environment meets Wang minimum recommendations.
3. All necessary dedicated power lines have been provided for.
4. An adequate number of outlets for present and any future expansion have been provided--important if the site is a specially built room.
5. The electrical system meets the standards outlined in Chapter 4.

#### 2.3 SITE CONSTRUCTION MATERIALS

Care must be exercised in the selection of materials used in constructing a computer room. Materials selected should meet area building codes, be fire resistance, and not prone to flaking or chipping. Floor materials should not shed or attract dust. All wiring must meet local and state electrical codes and should be installed by a qualified licensed electrician, preferably one familiar with computer installation requirements.

##### 2.3.1 FLOORING

When installing a computer room floor, consideration must be given to such factors as surface resistivity (static prevention), ease of maintenance, durability, appearance, and cost. Floors should resist scuffing, gouging, marking, and staining. Because floor covering material can contribute to the build-up of high static charges, tile or other floor coverings should have a surface resistance of 0.5 Megohms (minimum) to 20,000 Megohms (maximum), at operating limits of 40 to 60 percent relative humidity, and temperatures of 65° to 75°F (18° to 24°C). Figure 2-1 is a graph of the typical static voltages generated by walking on several common floor materials. The procedure outlined in NFPA No. 56A Chapter 462, Section 4628, (or equivalent) can be used in planning and installing computer room floors.

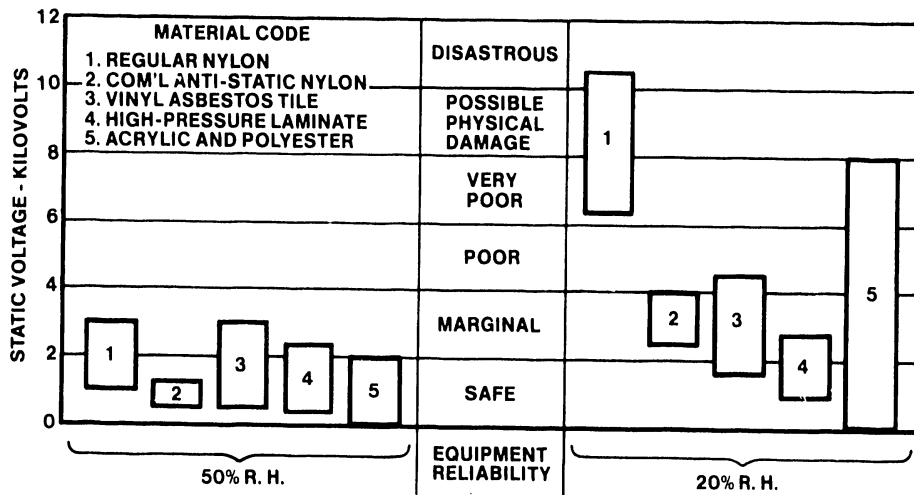

TYPICAL STATIC VOLTAGES GENERATED BY WALKING ON COMMON FLOOR COVERING MATERIALS

FIGURE 2-1 STATIC POTENTIAL OF COMMON FLOOR COVERINGS

If the customer chooses to construct a processor room, it is recommended that high-pressure laminated fiber-resin tiles be considered for the floor surface. These tiles are highly resistant to scratches, burns, scars, and dents. They require only an occasional damp mopping to maintain a good appearance. Vinyl tile is an alternate possibility because of its attractiveness, strength, and maintainability. Asphalt tiles are not recommended since they easily chip with wear, producing dust that can cause equipment malfunctions.

Wang does not recommend carpeting for computer rooms, because it tends to produce and hold dust. Many carpets also build up an electrostatic charge that is difficult to eliminate. This static build-up is uncomfortable to the operators and possibly damaging to the processing equipment.

### 2.3.2 FLOOR SEALERS AND FINISHERS

Sealers and wax should be applied by experienced floor treatment specialists. A sealer should be applied as soon as possible after the floor is laid, except in the case of linoleum, which should be allowed to cure for a week to allow the oils in it to settle. A polyurethane sealer is recommended for linoleum, wood, and cork. For other materials, a water emulsion sealer is more suitable.

Although wax forms a durable yet replaceable protective coating over a sealer, standard wax is not recommended for floors in computer areas. Because it tends to increase surface resistance, wax creates a dielectric that allows static electricity to build up on personnel and furniture. If used at all, wax should be applied sparingly and only to traffic routes where necessary. Other areas can simply be machine-buffed.

Tile floors should, however, be finished frequently with a "polymer" mixture containing microscopic metal flakes. These flakes reduce static build-up by forming a transfer medium to carry static charges safely away from processing equipment. The floor should be damp mopped every day and buffed with a sheepskin or equivalent pad. Do not use a bristle pad or a buffer.

To lessen the risk of damage caused by airborne contaminants when cleaning the equipment area floor, the following steps should be taken:

1. Remove Diskettes from drives before cleaning the area. Store them in a dry, cool location free from magnetic or radioactive fields.
2. Damp-mop tile floors, do not use dry or wet mops.
3. Vacuum carpeted floors using nonconducting nozzles.
4. Do not buff floors with steel wool.

### 2.3.3 RAISED FLOORING

Small systems with few peripherals do not require raised flooring, and even larger systems can be installed without it. However, for most systems a raised floor is a generally desirable feature because it provides the following advantages.

1. It simplifies installation and provides greater flexibility for subsequent layout changes or expansion.
2. It distributes the computer system load more equally while adding relatively little to the total floor load.
3. It simplifies equipment interconnecting (cabling).
4. It protects interconnecting cabling, plugs, and power connections.
5. It provides greater safety to personnel by eliminating the hazard of cabling underfoot.
6. Air from environmental equipment can be ducted beneath the floor directly to the equipment.



Raised floors are usually tile-covered panels supported by a grid system of either pedestals or pedestal support stringers, which provide lateral stability. The most common type of raised flooring is the pedestal type, desirable because it allows cable routing in any direction, minimizing cable lengths and increasing layout flexibility.

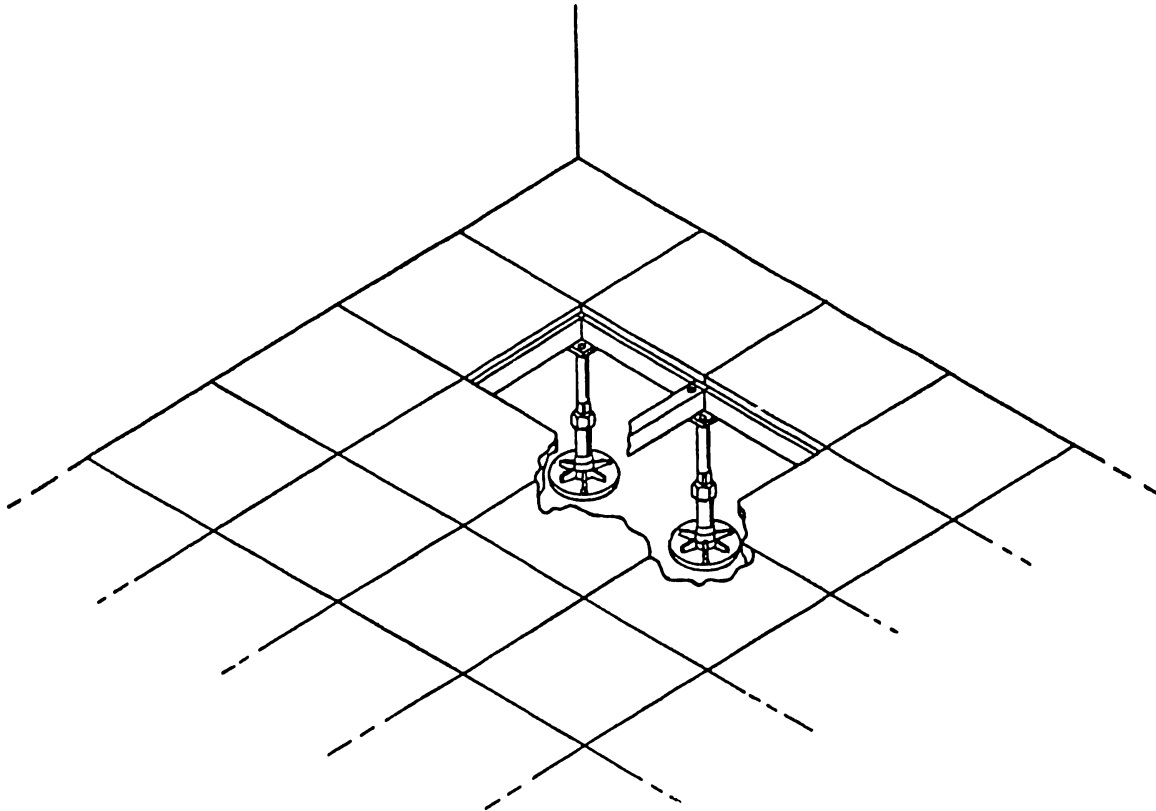

FIGURE 2-2 PEDESTAL-TYPE RAISED FLOORING

The raised floor must be able to support a load of  $200 \text{ lb/ft}^2$  ( $976 \text{ kg/m}^2$ ), with a concentrated load of 1000 lbs (450 kg) at any point. The floor must also be level to within  $\pm 0.01$ " ( $\pm 0.25\text{mm}$ ) per panel and  $\pm 0.06$ " ( $\pm 1.65\text{mm}$ ) in 10' (3.05m). The preferred height for raised floors is 12" (30cm), but should not be less than 11cm (4.5") in any case. There are a number of manufacturers whose raised floor products (made of steel, aluminum, or fire-resistant wood) meet these structural standards. Manufacturers brochures contain the necessary design specifications for use by an architect. Refer to Chapter 4 for raised floor grounding procedures.

## I.A.7.M-1

Openings in the raised floor should be protected by noncombustible covers or screens, or by locating equipment directly over openings to prevent debris from falling into them. Edges of Cable openings should be smooth or covered with a protective material to avoid cable damage.

## 2.4 CABLING

The components of all Wang Systems are supplied with interconnecting signal cables of standard lengths (see Appendix A) and a three-wire grounded power cord. In general, peripherals connect directly to the CPU. Some disk drives, however, can connect indirectly by chaining to another drive.

There are three common methods of running cables at an installation site. The first of these methods uses plastic cable troughs. Plastic troughs are recommended to protect interconnecting cables routed across a large floor area. Cable troughs may be bought from suppliers in varying widths, lengths, and heights to accomodate system cabling.

An alternate method is overhead cable routing. This method eliminates long cable trough runs when the system is installed in the center of a large floor area. The cables may be routed above the ceiling and dropped to the system components. All interconnecting points must be firmly supported. Cables should not be routed near any ac lines or other powered equipment.

A third method utilizes the raised floor (refer to Paragraph 2.3.3). This system allows cables to be run under the floor and out of the traffic areas with relative ease, as cables can be run directly from device to device.

Ensure that all equipment is positioned to connect directly to a power outlet. The grounded power cords on all Wang equipment must be connected directly to these outlets. Do not use extension cords to connect any part of a Wang system (including peripherals) to a power outlet.

### 2.4.1 INTERBUILDING CABLING

Cables for installations requiring building-to-building connections must be routed in underground conduit to protect them both physically and

electrically. Metal conduit must incorporate a true earth ground to shield the system cables from any electromagnetic interference (EMI) such as lightning, which can destroy both hardware and software elements of a system. Polyethylene water pipe or metal conduit, available in several diameters, affords good protection to the cable and usually makes it possible to replace damaged or failed cabling without digging up the area.

#### NOTE

All underground cables require conduit unless otherwise specified.

Conduit should be buried in sand or finely pulverized dirt containing no sharp stones or rubble. Four to six inches of sand should be tamped into the trench before laying the conduit, another six to eleven inches of sand should be tamped above the conduit. To protect the conduit against possible damage caused by digging or driving stakes in the area, a pressure-treated or creosoted board may be placed in the trench above the sand layer.

The cable should lay in the conduit with some slack. Check the cable as it is laid for cable jacket damage. Also, it is strongly recommended that the cable be buried below the frost line to prevent damage from the expansion and contraction of the earth due to frost heaves.

Prior to the system installation date, a qualified electrical contractor should be consulted about cable requirements and the incorporation of a true earth ground for interbuilding metal conduits.

## 2.5 PHYSICAL SPECIFICATIONS OF WANG PROCESSORS

Following are physical specifications for various Wang processing units.

### A. VS Processing Units

<u>MODEL</u>	<u>SPECIFICATIONS</u>		<u>SERVICE CLEARANCES</u>	
VS 25	Height	N/A	Front	N/A
	Depth	N/A	Rear	N/A
	Width	N/A	Left	N/A
	Weight	N/A	Right	N/A
			Top	N/A
VS 50/60/80	Height	41" (104.1cm)	Front	36" (91.4cm)
	Depth	31.5" (80cm)	Rear	30" (76.2cm)
	Width	35.5" (90.2cm)	Left	0.0
	Weight	353lbs (158.8Kg)	Right	0.0
			Top	48" (120cm)

I.A.7.M-1

VS 100	Height	41" (104.1cm)	Front	36" (91.4cm)
	Depth	32" (81cm)	Rear	30" (76.2cm)
	Width	48" (122cm)	Left	0.0
	Weight	750lbs (340 Kg)	Right	0.0
			Top	78" (198cm)

B. 2200 Systems

<u>MODEL</u>	<u>SPECIFICATIONS</u>	<u>SERVICE CLEARANCES</u>
2200 A/B/C	Height 9.8" (24.8cm) Depth 16" (40.6cm) Width 17" (43.2cm) Weight 24lbs (10.9Kg)	Front N/A Rear N/A Left N/A Right N/A Top N/A
2200 S/T	Height 9.8" (24.8cm) Depth 21" (53.3cm) Width 14.5" (36.8cm) Weight 40lbs (18Kg)	Front N/A Rear N/A Left N/A Right N/A Top N/A
2200VP	Height 14.5" (63.5cm) Depth 10" (25.4cm) Width 25" (63.5cm) Weight 47lbs (21.1Kg)	Front 20" (50.8cm) Rear 0.0 Left 0.0 Right 0.0 Top 18" (45.7cm)
2200LVP	Height 27" (68.6cm) Depth 30" (76.2cm) Width 20.4" (51.8cm) Weight 160lbs (72.6Kg)	Front 12" (30.5cm) Rear 30" (76.2cm) Left 6" (15.2cm) Right 6" (15.2cm) Top 12" (30.5cm)
2200MVP	Height 14.5" (36.8cm) Depth 10" (25.4cm) Width 25" (63.5cm) Weight 47lbs (21.3Kg)	Front 20" (50.8cm) Rear 0.0 Left 0.0 Right 0.0 Top 18" (45.7cm)
2200SVP	Height 12" (30.5cm) Depth 26" (66cm) Width 21.5" (54.6cm) Weight 75lbs (34.1Kg)	Front 26" (66cm) Rear 6" (15.2cm) Left 6" (15.2cm) Right 6" (15.2cm) Top 26" (66cm)
PCS-II	Height 18.75" (47.6cm) Depth 20.5" (52.1cm) Width 19.75" (50.2cm) Weight 51lbs (22.9Kg)	Front 36" (90cm) Rear 0.0 Left 12" (30.5cm) Right 12" (30.5cm) Top 24" (61cm)

C. WP/OIS Systems

<u>MODEL</u>	<u>SPECIFICATIONS</u>	<u>SERVICE CLEARANCES</u>
System 5	Height 13.25" (33.6cm) Depth 22" (55.9cm) Width 16.5" (42cm) Weight 72.5lbs (32.9Kg)	Front 30" (76.2cm) Rear 12" (30.5cm) Left 12" (30.5cm) Right 12" (30.5cm) Top 14" (35.6cm)

<u>MODEL</u>	<u>SPECIFICATIONS</u>	<u>SERVICE CLEARANCES</u>
System 20	Height 13.25" (33.6cm) Depth 22" (55.9cm) Width 16.5" (42.0cm) Weight 72.51bs (32.9Kg)	Front 30" (76.2cm) Rear 12" (30.5cm) Left 12" (30.5cm) Right 12" (30.5cm) Top 14" (35.6cm)
System 25/30	Height 13.25" (33.6cm) Depth 22" (55.9cm) Width 16.5" (42.0cm) Weight 201bs (9Kg)	Front 30" (76.2cm) Rear 12" (30.5cm) Left 12" (30.5cm) Right 12" (30.5cm) Top 14" (35.6cm)
OIS 105/115	Height 14.2" (36.2cm) Depth 23" (58.4cm) Width 21.2" (53cm) Weight 701bs (31.5Kg)	Front 25" (63.5cm) Rear 18" (45.7cm) Left 10" (25.4cm) Right 10" (25.4cm) Top 20" (50.8cm)
OIS 125/130	Height 13.25" (33.6cm) Depth 22" (55.9cm) Width 16.5" (42cm) Weight 201bs (9Kg)	Front 30" (76.2cm) Rear 12" (30.5cm) Left 12" (30.5cm) Right 12" (30.5cm) Top 14" (35.6cm)
OIS 125A/130A	Height 14.2" (36.2cm) Depth 23" (58.4cm) Width 21.2" (53cm) Weight 401bs (18Kg)	Front 25" (63.5cm) Rear 18" (45.7cm) Left 10" (25.4cm) Right 10" (25.4cm) Top 20" (50.8cm)
OIS 140/145	Height 28.5" (72.4cm) Depth 30" (76.4cm) Width 24" (61cm) Weight 2001bs (90Kg)	Front 30" (76.2cm) Rear 30" (76.2cm) Left 0.0 Right 0.0 Top 18" (45.7cm)

Specifications listed as N/A were not available at time of publication.

**CHAPTER**

**3**

**OPERA-**

**TING**

**ENVIRON-**

**MENT**

## CHAPTER 3 OPERATING ENVIRONMENT

### 3.1 ENVIRONMENT

Temperature, humidity, airborne dust, and electrical noise in prospective installation sites should be evaluated during the planning stage and controlled, if necessary, before system installation. In general, if the installation site is comfortable for operators, it will be satisfactory for the system.

Ideally, air-conditioning and other environmental control equipment should be located outside the computer site to minimize the noise level and to reduce the possibility of electrical interference. Regardless of the physical location of the control equipment, it must NOT be connected to the power lines serving Wang equipment. If this is absolutely unavoidable, proper line filtering measures must be taken. If environmental control equipment must be installed in the equipment site, ensure that adequate space for proper operation and servicing of the unit is provided.

Environmental specifications for the system are also applicable to storage areas for magnetic media. In addition, the humidity and temperature in areas for paper storage should be maintained at the same levels as in the equipment room. Otherwise, differences in humidity may alter the size and weight of the paper when the documents are moved into the work area. A rapid change in environment can result in paper warpage, the most frequent source of feeding and stacking problems.

#### 3.1.1 TEMPERATURE

Excessive temperature will cause equipment failure. Because Wang systems are cooled by the surrounding room air, temperature control is probably THE most important environmental factor. Because the recommended range for Wang equipment is 60°F to 80°F (15°C to 28°C), the temperature in office buildings and most other installation sites using just the usual heating and air conditioning units is nearly always within the allowable limits for the

system. Nevertheless, the following factors should be considered when determining the adequacy of existing temperature controls.

1. Heat dissipated by the Wang system:

All electrical equipment generates heat that is discharged into the environment. This tends to raise the ambient temperature unless adequate air conditioning is provided. Specification sheets (see Appendix D) list the BTU ratings for various Wang components.

2. Heat dissipated by other equipment:

Heat is also generated by other equipment in an installation site (electric typewriters, lights, copying machines, and so forth). Approximately 3.4 BTU's per watt of electrical power are given off by such equipment--for example, a copier using 1426.5 Watts of power will give off 4850 BTU's when running (Watts multiplied by 3.4 equals BTU's). This is also the number of BTU's per hour of air conditioning required to keep the environment cooled.

3. Body heat:

Individuals occupying a room contribute approximately 400 BTU's per hour per person. This can be an important consideration if a large number of people will occupy a system installation site.

4. Air flow:

The volume, temperature, and humidity of fresh filtered air entering a computer site are major factors in determining the type of operating environment the processing equipment is kept in. Air flow and filtration are especially important in the maintaining of a cool dust-free environment.

5. Direct sunlight:

A window or glass wall area provides virtually no insulation against radiant energy from direct sunlight, which can raise the equipment temperature excessively without necessarily exceeding the allowable ambient air temperature. Drapes, shades, venetian blinds, or the like should be employed to protect the equipment from direct sunlight. If a large glass area cannot be shaded, commercially available glass tinting films that block heat-producing infrared rays are recommended.

When planning an installation, the BTU's generated by equipment and personnel must be obtained to calculate the size of the HVAC unit necessary to ensure proper environmental control. To obtain the total BTU's generated, add



the BTU ratings given for each system component. Add to this the BTU's for other equipment in the area (watt rating multiplied by 3.4) plus 400 BTU's times the number of people who will normally occupy the room. The result is a close approximation of the amount of air conditioning BTU's required to maintain an operating environment of 60°F to 80°F. (This formula does not take into account the BTU's necessary to maintain this range in an empty room.)

		: Sum of BTU's for Wang equipment (wattage x 3.4)
+		: Sum of BTU's for other equipment (wattage x 3.4)
+	400 x	: Number of people generally occupying the room
=		: BTU's of air conditioning required
		(1 Ton of A/C = 12,500 BTU/HR)

### 3.1.2 HUMIDITY

Proper humidity must also be maintained in the equipment room. For the proper functioning of Wang equipment, relative humidity between 40%-60% (non-condensing) in the equipment areas and 35%-65% in storage areas is recommended. Humidity levels approaching the maximum limit can have an adverse effect on overall operating efficiency; for example, it can cause improper paper feeding in printers or improper flight of the magnetic heads in drives. In extremely humid environments it is advisable to install a dehumidifying unit in the equipment room.

Because most heating and air conditioning systems have a drying effect on the environment, too low humidity is often a problem. This is especially true during the winter months when the air is naturally drier to begin with. When the humidity is too low, a process known as "oxide shed" occurs in disk and tape drives, where the magnetic coating on the media wears off and causes excessive oxide build-up on the heads, causing I/O errors and loss of data.

Static charges, which are usually dissipated without any adverse effects, tend to increase significantly when the humidity is low. These charges can destroy data in memory and on a rotating magnetic disk, which is particularly susceptible to static buildup. Proper equipment grounding minimizes this effect, but does not eliminate it completely. In very dry areas, it may be necessary to install a humidifier to add moisture to the air.

3.1.3 DIRT AND DUST

The amount of airborne contaminants usually found in business environments will not interfere with the normal operation of Wang equipment. If a system must be installed in an area having a high dust content, or where there is exposure to abrasive materials or corrosive gases, extraordinary precautions should be taken to keep dust, dirt, and other foreign matter away from the equipment. (Installation in this type of environment is not recommended.)

Airborne dust or dirt particles can cause equipment malfunction or maintenance problems. If a film of dust or dirt accumulates on internal surfaces, excessive wear of mechanical parts (disk heads, tape transports, printer mechanisms, and so forth) can occur and electronic components may short and malfunction. Disk storage units are especially vulnerable to damage from excessive dust. Because the read/write heads of a disk drive cannot ride over dirt particles, head crashes can result. Every possible effort should be made to maintain a dust-free environment.

Usually, dust can be effectively controlled by filters installed in the normal heating, ventilating, and cooling equipment. These filters must be cleaned or replaced at regular intervals to ensure not only proper dust filtering, but proper temperature control as well. If the usual filter does not control dust effectively, an electrostatic filter should be installed.

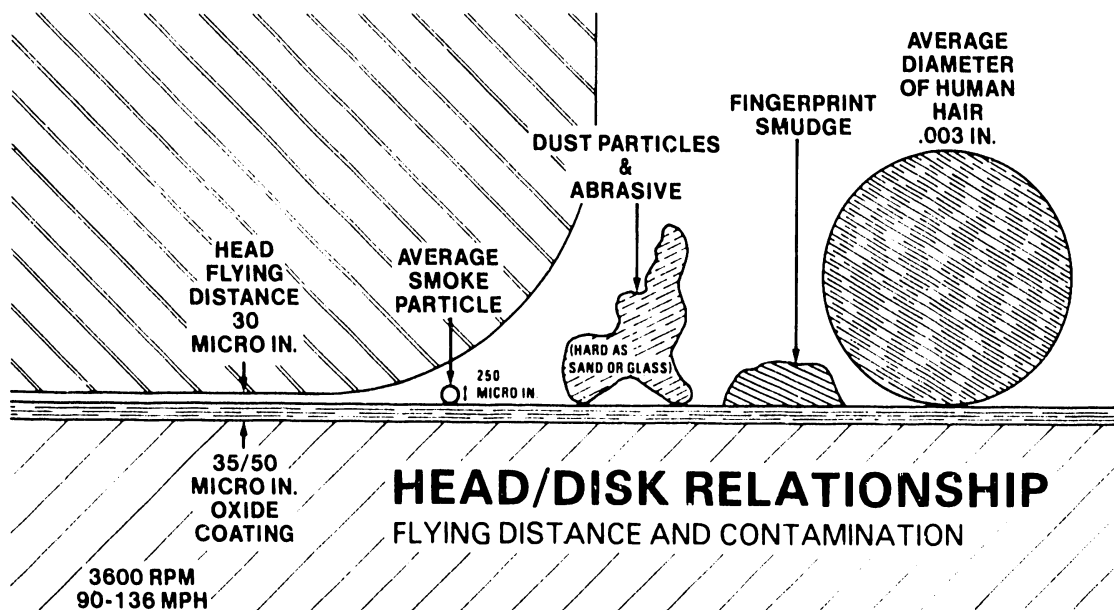

FIGURE 3-1 HEAD/DISK GAP IN RELATION TO POSSIBLE CONTAMINANTS

### 3.2 SYSTEM RELIABILITY VERSUS ENVIRONMENT

The reliability of a computer system is a complex function of the task it is expected to perform and its environment. The task the computer performs establishes criteria which define when the system has failed and to what extent. A computerized telephone switching center might allow a total of only 2 hours of down-time in 20 years of operation, but might not consider computation errors or system parts failure as serious errors. An on-line laboratory computer, however, may require complete error-free operation for several hours, but allow substantial amounts of scheduled down-time before and after each experiment. The requirements and techniques for any individual application are beyond the scope of this publication, but some non-environmental factors to be considered are as follows:

1. Time interval before data is irretrievably lost.
2. Use of a small, independent subsystem for data capture.
3. Significance of a data error.
4. Significance of extended down-time.
5. Partially or completely redundant system with manual or automatic system changeover.
6. Graceful system degradation upon subsystem failure.
7. I/O device-independent software.

Numerical mean-time-between-failure statistics are merely another way of expressing average unfamiliarity of the fundamental failure mechanisms in a system. As these fundamental failure mechanisms become known, they are designed out of systems and the systems become more reliable; that is, the technology become more mature. Because the environment has a marked effect on reliability, maintaining a more controlled environment is another way to increase system reliability.

High temperatures increase the rate of deterioration of virtually every material. Temperature cycling and thermal gradients induce temporary and permanent microscopic changes in materials. High absolute humidity (dew point) causes moisture absorption and dimensional and handling changes in paper and plastic media (printer paper, cards, paper tape, magnetic tape, etc.)

Low humidity allows the build-up of static electricity. Lack of air cleanliness results in reduced life of tapes, excessive head wear, and data errors in all moving magnetic storage media. The combination of static electricity and air-borne dust is particularly detrimental to magnetic tapes. Vibrations can cause slow degradation of mechanical parts and, when severe, can cause data errors on disks.

High-power radio frequency pulses conducted through the power mains or radiated through space, when severe, can cause hardware logic errors. Such pulses are generated by radar installations, nearby broadcasting stations, welding operations, and from less obvious sources such as nearby arcing relay or motor contacts, and the arcs that occur when static electricity is discharged. In extreme circumstances, filtered or isolated power mains and/or radio frequency shielding (a screened room) is required.

### 3.3 MAKING THE ENVIRONMENT SAFE

The following paragraphs provide suggestions for maintaining a safe environment for both the system and the user. These measures are intended to reduce or prevent disruptions in service or damage to equipment in the event of a natural disaster. Because of the growing dependence of many firms on data and word processing equipment, any major disruption in proper system function can have an adverse effect on a firm's overall performance. Before incorporating specific safeguards, the end user and a Wang representative should review any threats posed to the equipment by the environment and select a cost-effective security program to protect the user's investment.

#### 3.3.1 FIRE PROTECTION

The computer installation should be located away from areas in which flammable or explosive materials are manufactured, stored, or processed. If proximity to such areas is unavoidable, take necessary appropriate precautions. Because properly locating and installing sprinkler heads, fire and smoke sensing devices, and other fire extinguishing equipment requires specialized training, local experts should be consulted during the planning stage. Also, the recommendations of insurance underwriters and local building authorities should be sought and followed as closely as possible.

Some fire precautions can be implemented during the construction phase of a computer installation. For example, walls enclosing a computer area should extend from floor to ceiling, and those walls, the floor, and the dropped ceiling, if any, should be constructed of noncombustible materials. If the structural floor is made from combustible material, it should be covered with a noncombustible covering. The space between the raised and permanent floors should be cleared of all debris before the computer system is installed.

If a site has one or more outside walls adjacent to a building that is susceptible to fire, provisions should be made for the installation of shatterproof windows, as well as for the placement of sprinklers outside and above those windows to protect them with a blanket of water. The roof or floor above the computer and storage areas should be watertight to avoid possible water damage to equipment in case of fire on a floor above the installation. Ducts and plumbing work for air-conditioning systems should be designed to inhibit the spread of fire, heat, and smoke from one part of the building to another.

The master fire extinguishing system can be of the water sprinkler, carbon dioxide, or hydrocarbon bromide type. Water sprinklers are generally the least expensive, but are also most likely to cause severe damage to equipment or records. If a sprinkler system is used, it should be the "dry pipe" type, which when a fire is detected, interrupts power to the room and opens a master valve to fill the overhead sprinklers. If the fire detection system is of the type that shuts off the power to the installation, a battery-operated emergency light source should be provided.

Carbon dioxide flooding systems cause considerably less damage than sprinklers, but require immediate (within 30 seconds) evacuation of personnel when they are actuated, because they quickly exhaust the available oxygen supply. If this type of system is used, an alarm should sound 10 seconds before the release of the carbon dioxide to warn personnel in the area.

Use of hydrocarbon bromides, such as Halon 1211 and 1301, as extinguishing agents is quite recent, and reduces equipment damage to a minimum with virtually no personnel hazard. Note, however, that this system is more expensive than others mentioned and protection is lost once the Halon is

discharged. Refer to NFPA Standard No. 13-A for further information on this type of system.

Computer operation inevitably involves the use of large quantities of paper, making it necessary to provide for the regular and frequent disposal of any waste paper. Fire danger in general can be minimized by overall attention to good housekeeping practices.

### 3.3.2 SAFETY PRECAUTIONS

The following safety precautions are suggested, not because computer installations are inherently dangerous (a computer system actually presents fewer hazards than a television set), but because the investment represented by the equipment, installation, and data deserves appropriate protection.

Personnel should be trained in such emergency measures as the proper method of shutting off all electrical power, notifying the fire department clearly and promptly, handling fire extinguishers in the correct manner, and evacuating personnel and records.

Many codes (such as NFPA 70) require that each exit from a computer room be equipped with a control switch that will cycle off all power to the computer system and to the air-conditioning equipment in an emergency situation. A battery-operated emergency light source should be provided for such an event, and an emergency exit should be located in the computer area.

Incoming services such as steam, water, and power should be checked regularly, and pipes should be inspected for excess condensation, leaks, and corrosion. If power connections are made beneath a raised floor, waterproof electrical receptacles and connectors should be used. Proper earth grounds to equipment mainframes should be provided to protect operating personnel.

### 3.4 ENVIRONMENTAL SPECIFICATIONS OF WANG EQUIPMENT

Following are the environmental specifications for the various Wang processing units.

## A. VS Systems

<u>PROCESSOR MODEL</u>	<u>ENVIRONMENTAL SPECIFICATIONS</u>
VS 25	Temp. Range Max: 80°F (27°C) N/A Min: 60°F (15°C) Humidity Max: 60% (non-condensing) Min: 40%
VS 50	Heat Output N/A Temp. Range Max: 80°F (27°C) Min: 60°F (15°C) Humidity Max: 60% (non-condensing) Min: 40%
VS 60/80	Heat Output 6600 BTU/Hr, 1663 KCal/Hr Temp. Range Max: 80°F (27°C) Min: 60°F (15°C) Humidity Max: 60% (non-condensing) Min: 40%
VS 100	Heat Output 6000 BTU/Hr, 1512 KCal/Hr Temp. Range Max: 80°F (27°C) Min: 60°F (15°C) Humidity Max: 60% (non-condensing) Min: 40%
	Heat Output 8000 BTU/Hr, 2000 KCal/Hr

## B. 2200 Systems

<u>PROCESSOR MODEL</u>	<u>ENVIRONMENTAL SPECIFICATIONS</u>
2200 A/B/C	Temp. Range Max: 80°F (27°C) Min: 60°F (15°C) Humidity Max: 60% (non-condensing) Min: 40%
2200 S/T	Heat Output N/A Temp. Range Max: 80°F (27°C) Min: 60°F (15°C) Humidity Max: 60% (non-condensing) Min: 40%
2200VP	Heat Output N/A Temp. Range Max: 80°F (27°C) Min: 60°F (15°C) Humidity Max: 60% (non-condensing) Min: 40%
2200LVP	Heat Output 900 BTU/Hr, 227 KCal/Hr Temp. Range Max: 80°F (27°C) Min: 60°F (15°C) Humidity Max: 60% (non-condensing) Min: 40%
2200MVP	Heat Output 1050 BTU/Hr, 265 KCal/Hr Temp. Range Max: 80°F (27°C) Min: 60°F (15°C) Humidity Max: 60% (non-condensing) Min: 40%
	Heat Output 745 BTU/Hr, 188 KCal/Hr

I.A.7.M-1

2200SVP	Temp. Range	Max: 80°F (27°C) Min: 60°F (15°C)
	Humidity	Max: 60% (non-condensing) Min: 40%
	Heat Output	1050 BTU/Hr, 265 KCal/Hr
PCS II	Temp. Range	Max: 80°F (27°C) Min: 60°F (15°C)
	Humidity	Max: 60% (non-condensing) Min: 40%
	Heat Output	540 BTU/Hr, 136 KCal/Hr

C. WP/OIS Systems

<u>PROCESSOR MODEL</u>	<u>ENVIRONMENTAL SPECIFICATIONS</u>	
System 5	Temp. Range	Max: 80°F (27°C) Min: 60°F (15°C)
	Humidity	Max: 60% (non-condensing) Min: 40%
	Heat Output	941 BTU/Hr, 237 KCal/Hr
System 20	Temp. Range	Max: 80°F (27°C) Min: 60°F (15°C)
	Humidity	Max: 60% (non-condensing) Min: 40%
	Heat Output	941 BTU/Hr, 237 KCal/Hr
System 25/30	Temp. Range	Max: 80°F (27°C) Min: 60°F (15°C)
	Humidity	Max: 60% (non-condensing) Min: 40%
	Heat Output	855 BTU/Hr, 216 KCal/Hr
OIS 105/115	Temp. Range	Max: 80°F (27°C) Min: 60°F (15°C)
	Humidity	Max: 60% (non-condensing) Min: 40%
	Heat Output	1877 BTU/Hr, 473 KCal/Hr
OIS 125/130	Temp. Range	Max: 80°F (27°C) Min: 60°F (15°C)
	Humidity	Max: 60% (non-condensing) Min: 40%
	Heat Output	855 BTU/Hr, 216 KCal/Hr
OIS 125A/130A	Temp. Range	Max: 80°F (27°C) Min: 60°F (15°C)
	Humidity	Max: 60% (non-condensing) Min: 40%
	Heat Output	855 BTU/Hr, 216 KCal/Hr
OIS 140/145	Temp. Range	Max: 80°F (27°C) Min: 60°F (15°C)
	Humidity	Max: 60% (non-condensing) Min: 40%
	Heat Output	1877 BTU/Hr, 473 KCal/Hr



**CHAPTER**

**4**

**ELECTRI-**

**CAL**

**REQUIRE-**

**MENTS**

CHAPTER 4  
ELECTRICAL REQUIREMENTS

#### 4.1 POWER SOURCE

Power systems generally consist of the following elements and configurations:

1. Single-Phase Power--the simplest form of an ac system, it consists of a phase wire, a neutral wire, and a safety ground (often called 3-wire). It is used for primary circuits and small secondary circuits. Single-phase (60 Hz) power is used in certain tape drives, VS 60/80, WPS, MVP, LVP, Printers, Workstations, and Pheonix drives.
2. 2-Phase Power--Power is provided by one of two configurations: 4-wire (with safety ground), 120/240 Vac split phase (180 degrees displaced); and 4-wire (with safety ground), 120/208 Vac 2 of 3 Phases. Figure 4-1 is a two-phase configuration using a center tapped transformer with 120V potential between the center tap (neutral) and either of two outer legs. A 240V potential exists between the two outside (hot) legs, and the current in the neutral leg is zero when loads on both phases are balanced. Two-phase (60 HZ) power is used in the VS 100 and certain Storage Module Drives.
3. Single- and three-phase (50 HZ) Power--Used internationally. Refer to Appendices B and C for further information.

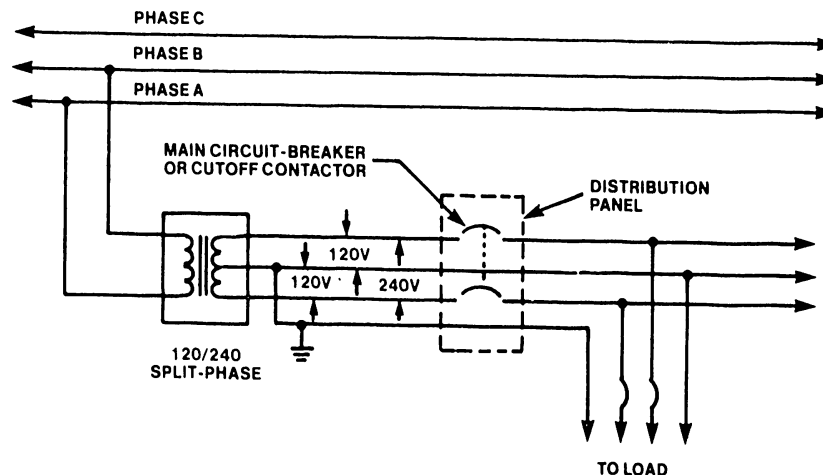

FIGURE 4-1 2-PHASE, 3-WIRE CONNECTION WITH SAFETY GROUND

The following figure shows a typical power distribution system for both a small and large building site feeding off a 3-phase, 3-wire, 2200V primary feeder. The smaller building is being fed with 2-phase, 120 Vac power, while the larger building is fed with 3-phase, 120 Vac/phase power from a Y-connected transformer.

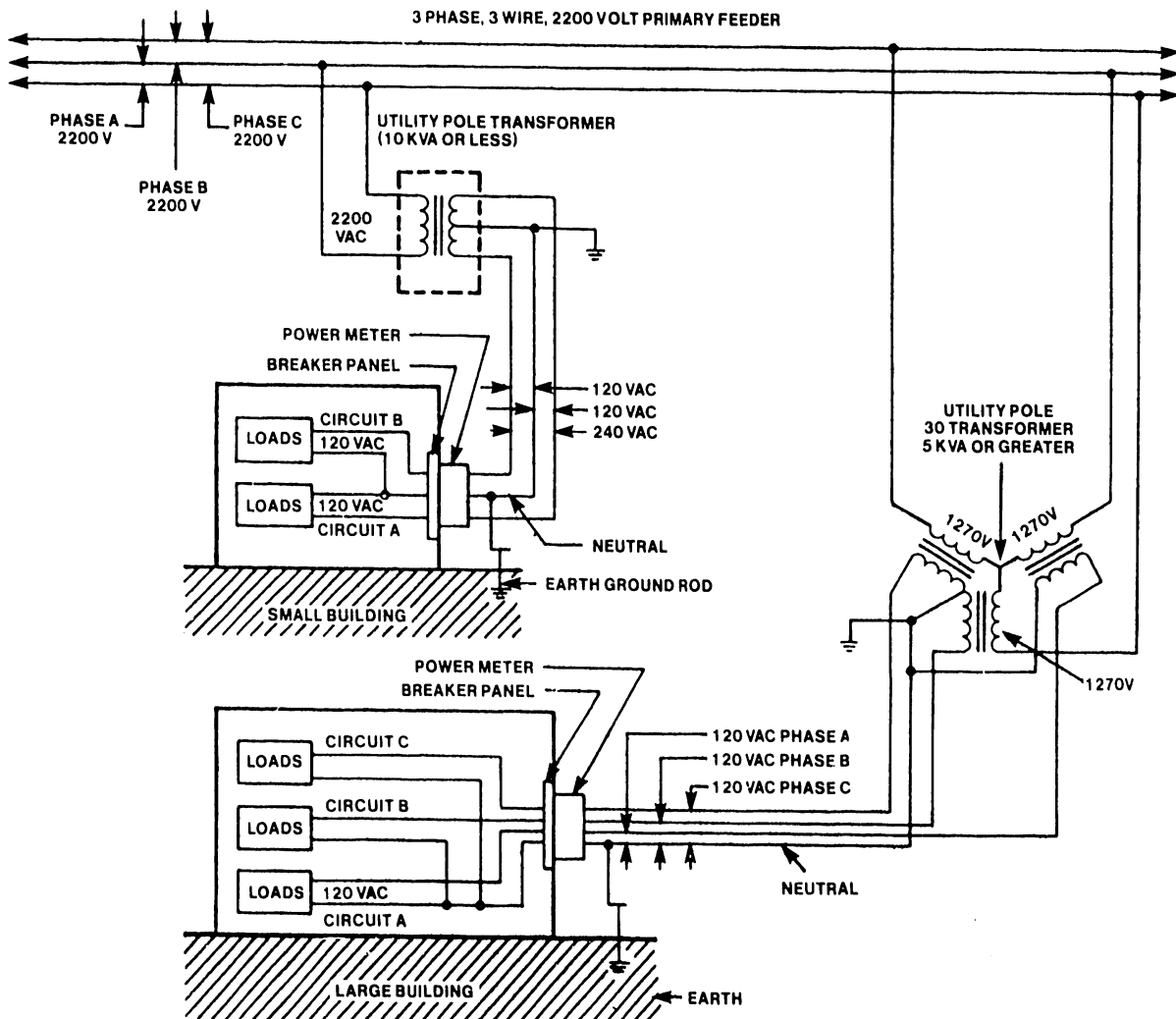

FIGURE 4-2 3-PHASE, 3-WIRE 2200 VOLT PRIMARY FEEDER

#### 4.1.1 POWER DISTRIBUTION

The primary power feed for an entire system (including peripheral components, systems in direct communication, laboratory data collection equipment, etc.) should be unique to that system. Power, therefore, for all system related components should be derived from the SAME power distribution panel. In some cases, however, this may not be possible. Various reasons for not using a unique system power feed include:

1. The new computer system requires more power than one feeder can supply.
2. The new computer system is linked to another pre-existing system which does not have enough reserve power to accomodate the new sytem
3. The power source of a pre-existing system is incompatible with new equipment being installed.
4. The new computer system is distributed over a very large area making branching from a single distribution panel impractical.

In the event that certain system components must derive power from a separate source, ensure that all power distribution points are referenced together and that each power reference point is at the SAME potential.

The Power Box, located within the equipment chassis, is the power distribution point for all subsystems within a cabinet; it is not designed to power external devices. The ac power cord for the box contains a separate insulated Green/Yellow conductor for safety ground which is connected to the equipment chassis. This conductor must then be connected to the system earth reference.

All electrical outlets providing power for a system must have a safety wire (Green or Green/Yellow) connecting the receptacle ground with the system earth reference at the distribution panel. These wires must be isolated from all connections, including building steel. When power wiring is run in either conduit or armored cable (Bx) between the receptacle and power distribution panel, it may be necessary to install Isolated Ground Receptacles. These receptacles are designed to isolate the safety wire from the metallic box. This effectively isolates the system safety ground from external noise sources (fault currents) back to the system earth reference. The system earth reference is then connected to the safety ground at one point (see Figure 4-3 and Paragraph 4.2).

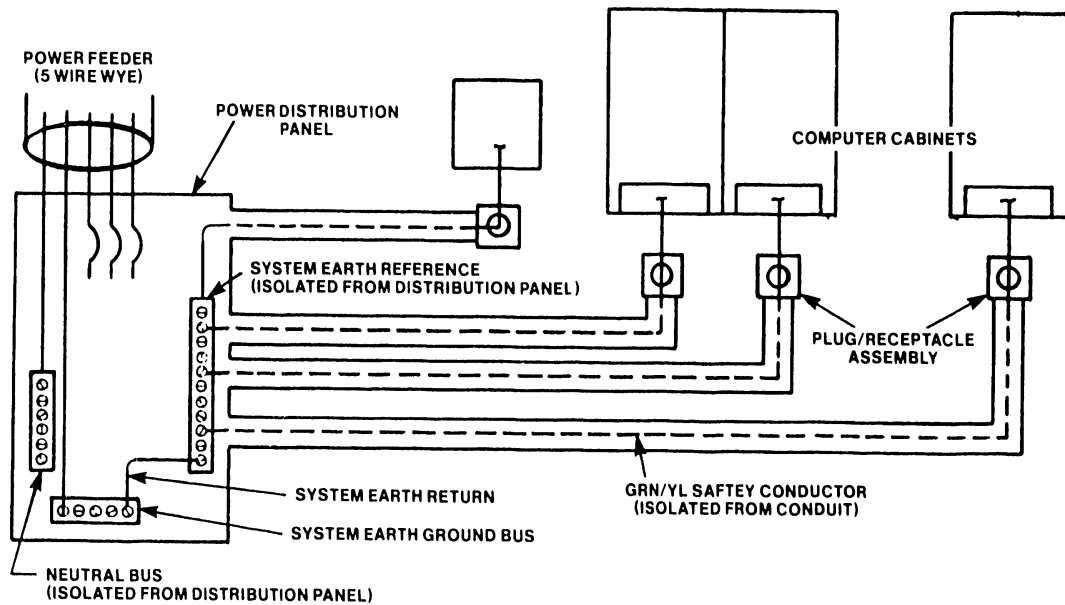
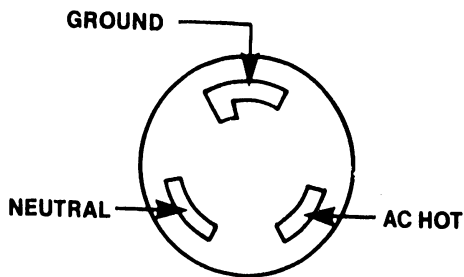

FIGURE 4-3 REPRESENTATIVE GROUND REFERENCE DISTRIBUTION

On small data processing systems requiring only one receptacle, the system earth reference can be identified as the connection within the receptacle. For larger systems requiring a power distribution panel, the system earth reference is identified as the junction where all the Green, Green/Yellow safety wires are tied within the panel.

#### 4.1.2 PLUGS AND RECEPTACLES

The type of primary power receptacle used depends largely on the requirements of the country in which the system is located. In the United States, power lines terminate where possible in NEMA type receptacles. The type of receptacles and the circuits they terminate into are shown in the following figure.



NEMA L5-30P & R  
HUBBEL NO. 2611 & 10  
120V, 30A SGL PHASE

VS 60 AND 80

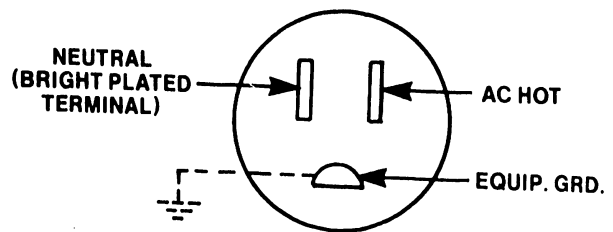

NEMA 5-15G  
120V, 15A, 60Hz,  
SGL PHASE, 2-POLE  
3 WIRE.

WORKSTATIONS, PRINTERS, TAPE.

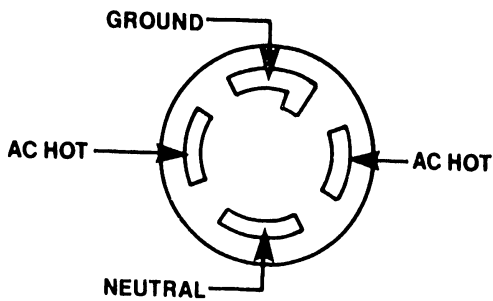

NEMA L14-30R & P  
HUBBEL 2711 & 10  
250V, 30A, 50Hz  
SPLIT PHASE, 3 POLE  
4 WIRE, TWISTLOCK.

VS 100

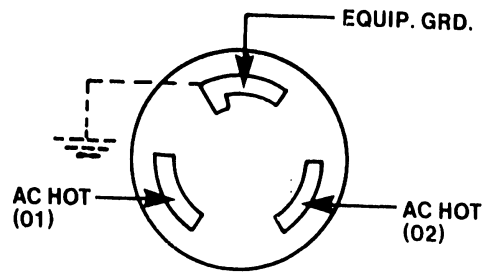

NEMA L6-20P 208/230V, 20A, 60HZ  
2 POLE, 3 WIRE, LOCKING CONN.

DISK-300 MEG

FIGURE 4-4 NEMA CONFIGURATIONS

#### 4.1.3 NEMA COLOR CODES

The National Association of Electrical Manufacturers have established a color code for wiring in an industrial site. Although this is a voluntary code, as a matter of consistency, Wang recommends adherence to it when wiring an installation site. The color code is as follows:

##### THREE-PHASE COLOR CODE

1. Green or Green/Yellow - Earth Ground
2. Black - Phase 1
3. Red - Phase 2
4. White, Grey or Blue - Neutral
5. Orange - Phase 3.

##### SINGLE-PHASE COLOR CODE

1. Green or Green/Yellow - Earth Ground
2. Black - Phase 1
3. White, Grey or Blue - Neutral

#### 4.1.4 CUSTOMER CONVENIENCE OUTLETS

It is recommended that all customer convenience devices--coffee pots, vacuum cleaners, electric typewriters, etc.--receive their power from a branch circuit independent from that powering the system. This branch circuit may be taken from the same primary power source as the system without adverse effects. The intent is to ensure that the system earth return does not carry earth return currents from the customer convenience devices.

#### 4.2 IMPORTANCE OF PROPER GROUNDING

An important part of site preparation is ensuring that both power and earth reference distribution comply with Wang specifications. The successful installation of a computer system requires precise planning and careful attention to the details of the ground distribution. This need should be approached by viewing the complete system in its physical and electrical environment. A properly planned site should include a diagram of the physical layout and an electrical diagram of the power and earth reference distribution.

#### 4.2.1 GROUND AS OPPOSED TO NEUTRAL (GROUND-NEUTRAL)

The word "ground" as it pertains to electricity means "a connection to the earth for conducting electrical current to and from the earth" (definition from IEEE No. 81). In recent years, this definition has been expanded to include the need to establish a reference potential. There are two purposes for establishing an earth connection to equipment and systems.

1. Safety - to prevent shock hazard in the event that an equipment chassis frame or housing develops a hazardous voltage due to lightning or an accidental breakdown of wiring or components.
2. Electromagnetic compatibility - to reduce susceptibility to interference, equipment chassis are earth referenced at a common point.

AC power distribution is governed by local, national and international regulations which deal with standards on wiring and other electrical requirements. All codes generally require the use of a safety (Green, or Green/Yellow) conductor for electrical equipment. The requirement, generally stated, is that each hot (phase) and return wire (neutral) from a power source to a piece of equipment be accompanied by a safety conductor (wire). The safety wire should be equal in size to that of the hot wire. This requirement applies to all power systems (that is, split-phase, delta, wye, and so forth).

Safety codes generally require that the safety ground wire be connected to any conducting surface on electrical equipment that can be energized by an electrical fault and that can be touched by an operator. This wire, under normal operation, will not carry 50/60 cycle ac return current.

The ultimate goal of any equipment grounding is to ensure personnel safety. To be effective, safety connections must provide a low-impedance path at power frequencies to earth. An ideal ground reference would be a zero-potential, zero-impedance system that could be used as a reference for both power and signal voltages. This would allow all undesirable signals and ambient radiation to be diverted to it. Ideally, it should be able to absorb all signals and radiation while remaining stable. This is the foundation for obtaining reliable, interference-free, safe equipment operation.



Without the safety ground, if the hot (phase) wire of a piece of equipment were accidentally shorted to the frame, the frame of the equipment would then become raised to a hazardous voltage level. Anyone touching the frame could become the current path to earth ground and be subject to a potentially severe shock. With a safety ground, shock hazards can be avoided because, if a fault occurs within the equipment, the safety wire acts as a return path providing a very low impedance connection. This in turn causes the circuit protection device (fuse or circuit breaker) to trip. All Wang equipment having a power cord leaving a cabinet has the green or green/yellow safety conductor from the ac power cord connected to the chassis.

Because of its multiple function--safety being the most important--all safety ground circuits must be carefully treated. The system's safety ground must be routed with the ac power conductors back to the power system transformer. The safety conductor must be insulated from conduit and other connections back to this point. The power transformer reference point must then be terminated at a low resistance earth connection.

In its path from the Wang cabinets to the transformer earth reference the grounding conductor should not connect to:

1. The ac neutral--this connection should be made only at the transformer or service entrance
2. Grounds from equipment which is not part of the computer system
3. Metal structural grounds, building steel, water pipes, etc.

#### 4.2.2 INSTALLING AN EARTH GROUND REFERENCE

This section discusses the techniques used in establishing earth grounding reference systems compatible with requirements of various structure types. To keep electrical noise under control and preserve system signal integrity, the safety ground system described in the following paragraphs is recommended. Other schemes may also provide adequate grounding; however, any alternate system should be carefully studied to ensure that compatible ground is provided.

In many customers minds, a good "ground" for an electrical system is a section of iron pipe driven into the earth with a wire conductor connected to

it from the building pipes. Because of the large amount of surface area exposed to the earth and the relatively large depths such piping is buried at, pipelines historically have been an excellent means for connecting structural steel and power distribution systems to earth. A problem with this practice has been the method of connecting the metallic structures above ground to the pipes using copper bonds or copper ground rods. Unfortunately, copper, when in its various forms, creates an undesirable coupling between dissimilar metals. In contact with iron or steel, copper acts as a cathode to accelerate corrosion, thereby increasing the bond impedance over a period of time.

Due to both the inherent susceptibility to corrosion and the cost of underground piping systems, utility companies are converting to coated or nonconductive pipes and couplings which will effectively eliminate this widely used method of grounding. As a result, building pipelines may be unsuitable paths for electrical current to flow (if a fault occurs) to protect personnel and equipment. Thus, to establish an effective noise-free ground (earth reference), it may be necessary to install dedicated grounding systems for all large computer installations. Resulting from the need for dedicated grounding systems, it becomes necessary to utilize ground stakes and meshes. (See Figures 4-5 and 4-6.)

#### 4.2.3 EARTH GROUND STAKES

A practical earth electrode (ground stake) that provides a low ground resistance is not always easy to obtain. Earth resistivity has an important bearing on resistance, as does depth, electrode size, and earth salt content. It is beyond the scope of this guide to go into detail about any of these parameters. It is mentioned, however, to give insight into the necessary considerations that must be included when designing a proper earth ground.

Current in a grounding system is primarily determined by the leakage current during normal operation of the electrical equipment. This current should, for safety reasons, be limited and is governed under various national and international standards. The effectiveness of a safety ground system is determined by its ability to shunt fault current to ground. To accomplish this, the resistance of the grounding system must be very small. Three components that contribute to the resistance of the grounding systems are:

1. Resistance of the conductor connecting to the ground stake.
2. Contact resistance between the ground stake and the soil.
3. Resistance of earth immediately surrounding the ground stake.

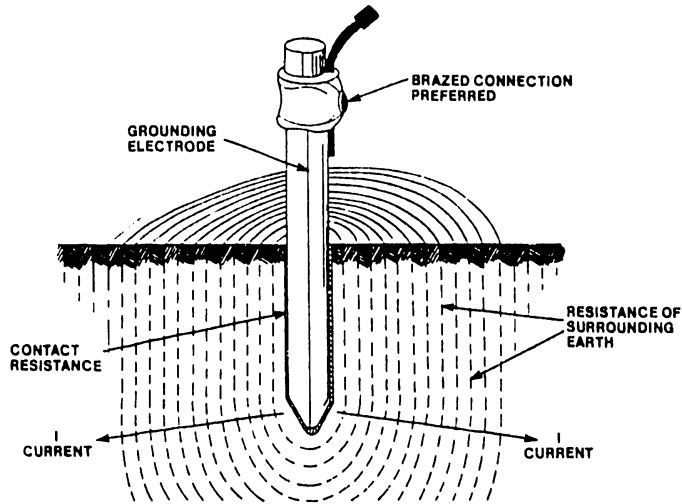

FIGURE 4-5 EARTH GROUND STAKE (Ground Rod)

#### 4.2.4 EARTH GROUND GRID MESHES

Ground-grid meshes, often needed to complement rods, can be used separately when deep-driven rods are impractical due to soil and terrain considerations. Grounding resistance can be reduced significantly below that of earth stakes by use of buried grid meshes. Increasing the number of grids or the area of grid coverage can also significantly lower ground resistance.

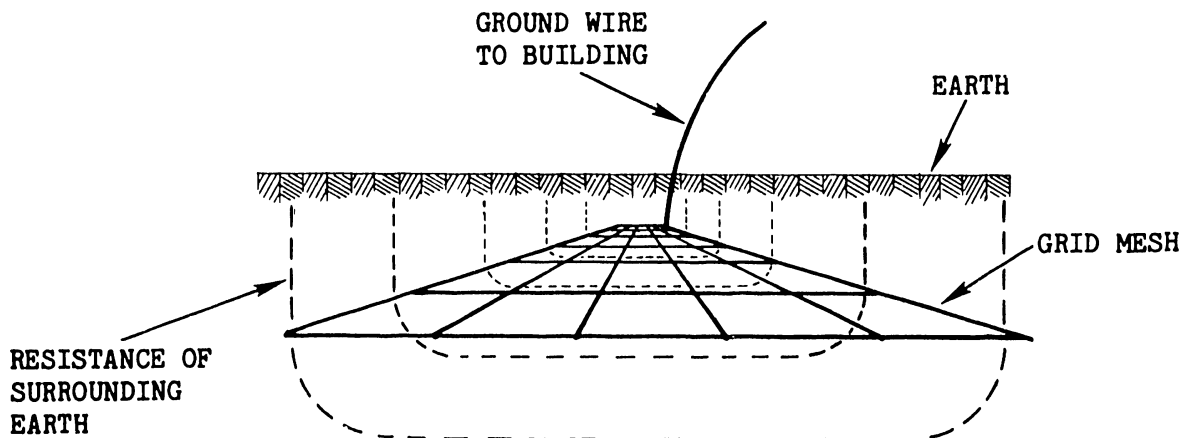

FIGURE 4-6 EARTH GROUND GRID MESH

Ground rod and grid-mesh criteria developed in these sections can be realized for effective implementation in extremely rocky or frozen soil, when deep penetration of ground rods is impractical. In such cases ground grids may be used. However, in regions subjected to extreme climatic variations, earth resistivity will vary considerably causing resistance changes in shallow buried grid meshes. In various localities with dry soils, earth resistivity may be extremely high regardless of the depth of the ground rod penetration. In situations such as these, other techniques may be utilized to obtain necessary low-ground resistance: impregnation of soil with salt solution, immersion of grid or plate in nearby water sources.

#### 4.2.5 TESTING EARTH GROUND

A convenient means should be provided to verify that the entire system is referenced to earth at one and only one point (the system earth reference point). It is necessary that this point be well defined, and labeled. It should additionally have a means of disconnection (single stud/lug) whereby this reference can be lifted and the system tested to determine if there is any point other than this one at which the system is referenced to earth.

Two tests can be performed to verify the proper isolation of the system reference point. These tests should only be performed with the assistance of an electrician.

1. With power applied to the system, measure the current in the system earth return wire. This measurement should be made with a device that can measure current without disconnecting the wire (a clamp-on ammeter). The maximum current in the system earth return should not exceed 3.5 mA (for new equipment) for every power cord exiting a cabinet in the system. Current in excess of this amount indicates improper primary power/reference distribution, and should be investigated before continuing.

---

**\*\*\*WARNING\*\*\***

When the system earth reference is removed from the primary or dedicated safety earth ground bus in the following step, there may exist hazardous voltages between the system earth-return wire and the safety earth ground bus. This wire should thus be handled accordingly. Before any resistance measurements are made that require the disconnection of this return wire, the voltage between the system earth return wire and the safety earth ground bus should be measured to determine if a hazardous condition exists.

---

2. Remove primary power to a system as follows, depending on system size:
  - a. Open the dedicated system circuit breakers at the customer's power distribution panel on large systems.
  - b. For smaller systems not requiring a dedicated power panel, unplugging the ac power cords is sufficient.
3. Disconnect the system earth return from the safety earth ground bus. There should be a minimum of 100 ohms resistance between the system earth reference and the safety earth ground bus measured at dc. If this measurement is not correct, preventive steps must be taken to correct the problem.

#### 4.2.6. GROUNDING A RAISED FLOOR

For safety purposes, the separate pedestals of a raised floor should be grounded. This can best be achieved by connecting the floor grid to the safety earth ground bus in the distribution panel. It must be understood that when it is attached to this point, it must be isolated from building steel, electrical conduit, air-conditioning duct, etc. If this is not accomplished, sneak paths for external currents and EMI may contaminate the system reference.

#### 4.3 WIRING THE SELECTED SITE

Ensure that all wiring installed expressly for Wang equipment has been inspected and tested before the equipment is connected to it. If possible, a Dranetz Power Analyzer (see Figures 4-7 and 4-7A) should be attached to the incoming line to monitor the source power for voltage fluctuations that could result in equipment problems.

During pre-site surveys, many local electricians request to know what voltage variations that Wang systems can handle. Listed below are the specifications for the line filters currently installed in all Wang processor power boxes.

1. Handles transients up to 10 joules.
2. Handles peak currents of 1,000 amps for pulse durations of less than 20 micro-seconds, and frequencies from 1 HZ to 10 MHZ.
3. Handles voltage amplitude of 190V peak.

**Model 606-1 (Single Channel)**

**3-Wire Wall Receptacle**

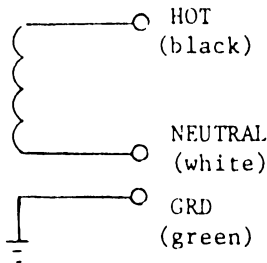

**Nominal Input Switch = 115V**

Channel	Mode	Terminal	Wire
A	Normal	A1	Black
		A2	White

**Green wire to Frame Ground Terminal**

**Model 606-3 (Three Channel)**

**3-Wire Wall Receptacle**

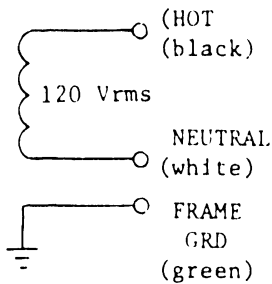

**Nominal Input Switch = 115V**

Channel	Mode	Terminal	Wire
A	Normal	A1	Black
		A2	White
B	Common	B1	Black
		B2	Green
C	Common	C1	White
		C2	Green

FIGURE 4-7A DRANETZ CONNECTIONS

**4.4 PROBLEMS WITH POWER AND POSSIBLE SOLUTIONS**

A clean dependable power source is essential for the continued good operation of any system, whether small or large. In these days of brownouts, contaminated power, and sporadic failures, however, dependable power input is sometimes a hard goal to achieve. The best a user can hope for is power adequate enough to keep a system functioning as near normal as possible. The following paragraphs describe several power-related problems and how to correct or minimize them. The quality of power supplied to any system is dependent on the generating source, about which the CE and the user can do very little; the in-house wiring, which is directly related to the care taken when installing it; and the number and size of electrical devices attached to the power line.

#### 4.4.1 VOLTAGE REDUCTIONS

Power companies are responsible for maintaining normal line voltage. They measure it at the 'load center'--a point half-way between the closest and farthest users--of the distribution line. This is called the 'nominal set point', and it represents an average line condition. A tap at this exact point has the best chance of delivering 120V to a customer. A user close to the generating source can receive a voltage of up to 130V, while users further down the line can receive voltages that commonly dip as low as 110V (5% to 8% below nominal rating).

Power distribution lines create both resistive and inductive voltage drops. Resistive and uncompensated inductive losses can result in a steady voltage drop along the length of the distribution line. As heavier loads are applied to the power line, losses increase. The voltage received, therefore, depends partly on the receivers position along the power line and partly on the size of the total load that the particular line is forced to supply. Because of the natural line resistance and inductive effects, under-voltages can exist continuously as a steady line condition.

Most building codes allow a voltage drop of 2 percent (111-108V) between the service entrance and the distribution panels. From the distribution panels to the point of utilization, we can expect another 1 percent (110-106V) voltage drop. Since most of the connections are made with compression fittings that loosen and corrode with age, these normal voltage reductions are usually stretched even further by poor contacts. So, by the time source power reaches the computer installation site, it can be suffering voltage losses of up to 11 percent (106V) even under optimal conditions (normal transmission losses of up to 8% combined with in-house losses equals 11%).

Besides these normal conditions, in times of excess demand for power, utilities reduce their load by lowering line voltages. Although exact percentages vary with state regulations, a typical brownout might start with a three percent reduction (103V), then increase to five percent (101V) and finally, in extreme cases extend to an eight percent drop (98V). (Voltages calculated from 120V nominal.)

If the total voltage reduction from all these causes results in a 20 percent drop below the 120 nominal (96V), serious problems, such as garbled information, loss of memory, or complete shutdown, could occur. Table 4A shows the 5, 10, and 20 percent limits for the most common voltages, rounded up for positive, down for negative.

TABLE 4A VOLTAGE RANGES

-20%	-10%	-5%	NOMINAL VOLTAGE	+5%	+10%	+20%
80	90	95	100	105	110	120
84	94	99	105	111	116	126
88	99	104	110	116	121	132
92	103	109	115	121	127	138
96	108	114	120*	126	132	144
102	114	121	127	133	140	152
120	135	142	150	158	165	180
166	187	198	208	218	229	250
176	198	209	220	231	242	264
184	207	218	230*	242	253	276
192	216	228	240	252	264	288
200	225	242	250	258	275	300

\* Recommended nominal voltage at power distribution panel.

#### 4.4.2 POWER FLUCTUATIONS

Another problem associated with voltage at the system source is fluctuating power caused by dynamic loading. Fluctuating power is transient (spike) free ac voltage that, due to external loads, etc., is coasting up and down outside the required specification. To correct such problems, there are two possible approaches:

1. Isolate and disconnect offending loads from the computer power system.
2. Install a constant voltage transformer or other appropriate equipment.

Two likely results of an energy shortage are brownouts and blackouts. In the case of brownout conditions (defined as a planned voltage reduction of a certain percentage at the power plant), unless the computer user has some



mechanism such as a step-up transformer to raise the computer voltage, the computer could be operating dangerously close to its lower steady-state voltage limit. Any transient voltage dip could drop the voltage well below its rated limit for a sufficient time to cause output errors and/or shutdown.

Transient dip fluctuations encountered on power lines are called sags (and its converse, surge). Sag and surge disturbances refer to rapid increases or decreases in the magnitude of the sine wave that persist for at least the substantial part of one cycle (usually several cycles) of the line frequency. These variations are caused by fault and the resulting actions of the fault clearing device or by abnormalities caused by large load changes and the resulting actions of the utility-regulating devices and procedures

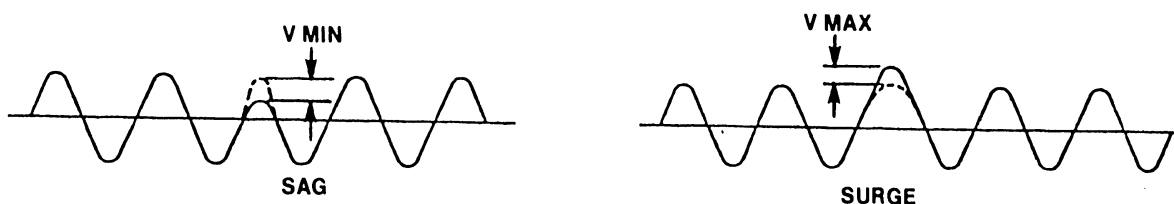

FIGURE 4-8 SAG AND SURGE WAVEFORMS

#### 4.4.3 TRANSIENTS

The third voltage variation that affects data processing equipment is transient impulses. Transients (sometimes called impulses) are defined as brief deviations from the ideal power-frequency sine wave with a duration that is short compared to one cycle of the line frequency. Characteristically, these impulses last from less than 200 nanoseconds to a few milliseconds. Waveforms range from single, fast rising, exponentially delaying pulses to relatively undamped oscillatory disturbances that can persist for up to 10 oscillations, within an exponentially decreasing envelope. The initial deviation may be upward, increasing the instantaneous amplitude of the ideal waveform (called a 'spike') or downward, decreasing the instantaneous amplitude of the ideal waveform (called a 'notch' or 'dip').

Spikes or dips are caused by a number of factors, including high-speed switching by local power utilities to correct the power factor or the voltage as the load changes during the day. Heavy loads or disturbances coming on-line such as air conditioners, transformers, or lightning may require this corrective action. The problem can also be caused by a variety of industrial, medical, communications or other equipment in the vicinity of the power company's distribution lines, or within or adjacent to the computer site. Electro-mechanical equipment such as adding machines or card punches on the same power line as the computer, may under certain conditions cause intermittent electrical disturbances. To correct such problems, isolation and ultra-isolation transformers are used.

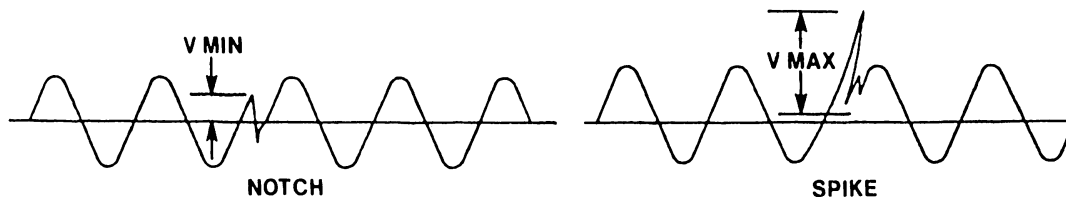

FIGURE 4-9 IMPULSE WAVEFORMS

#### 4.4.4 CORRECTING POWER PROBLEMS

Whenever source power is suspect, reliability and quality checks should be performed with a power monitor. A Dranetz Analyzer with strip-chart recorder connected to all incoming power phases will pinpoint problems caused by power fluctuations, especially transients. By comparing the results of these tests with actual system problems, it can be determined if the incoming power is the cause of system problems. Test results plus a cost estimate of actual system down-time caused by incoming power problems is used to determine what action should be taken to correct power-related problems.

There are a several methods of dealing with power problems. Voltage-regulating transformers compensate for brownouts. Diesel- or turbine-driven

generators provide local (albeit expensive) power if protection against long-term power failures is needed. Uninterruptible Power Systems (UPS) filter out transients and protect against brief power failures by storing energy internally. Rotary UPS use a motor-generator with a flywheel for energy storage; they are relatively inexpensive, but are noisy, require regular maintenance, and can support the load for only 10 to 15 seconds when power fails--enough time to bring a system down without damage to important data or equipment. Electronic UPS use a solid-state rectifier-inverter set with a battery which can carry the load for up to 45 minutes.

The ideal system uses an electronic UPS, a diesel or turbine generator set, and transfer switches. It assures the delivery of high-quality power and can survive power failures of indeterminate length. In the event a UPS fails, a solid-state bypass switch transfers the computer load to the incoming electric power source within a few milliseconds. This last system is almost prohibitively expensive for small firms. In large installations where down-time is critical, however, it is a system that should be considered.

A full-blown emergency power system must have enough capacity to support the computer hardware, communications and data encoding equipment, air conditioning, a minimum of lighting and (possibly) elevators, and security hardware. Only uninterruptible or transient sensitive loads need be connected to the UPS. Proper design of the UPS, emergency generator, transfer and bypass switches, and their integration into the building's electrical service must be done by qualified engineers for best results.

#### 4.5 ELECTRICAL SPECIFICATIONS OF WANG EQUIPMENT

Following are the electrical specifications for the various Wang processing units.

##### 1. VS Systems

<u>PROCESSOR MODEL</u>	<u>ELECTRICAL SPECIFICATIONS*</u>
VS 25	Operating Voltage: N/A Amperes: N/A Watts: N/A
VS 50	Operating Voltage: 115Vac/60Hz, 230Vac/50Hz Amperes: 12A @ 115V/6A @ 230V Watts: 1380

VS 60/80	Operating Voltage: 115Vac/60Hz, 230Vac/50Hz Amperes: 12A @ 115V/6A @ 230V Watts: 1380
VS 100	Operating Voltage: 208Vac (2 of 3 phases)/60Hz, 230Vac (split phase)/60 Hz Amperes: 17A Watts: 2600

2. 2200 Systems

<u>PROCESSOR MODEL</u>	<u>ELECTRICAL SPECIFICATIONS*</u>
2200 A/B/C	Operating Voltage: 115Vac/60Hz, 230Vac/50Hz Amperes: N/A Watts: N/A
2200 S/T	Operating Voltage: 115Vac/60Hz, 230Vac/50Hz Amperes: N/A Watts: N/A
2200VP	Operating Voltage: 115Vac/60Hz, 230Vac/50Hz Amperes: 3A @ 115Vac/1.5A @ 230Vac Watts: 230
2200LVP	Operating Voltage: 115Vac/60Hz, 230Vac/50Hz Amperes: 3A @ 115Vac/1.5A @ 230Vac Watts: 230
2200MVP	Operating Voltage: 115Vac/60Hz, 230Vac/50Hz Amperes: 3A @ 115Vac/1.5A @ 230Vac Watts: 230
2200SVP	Operating Voltage: 115Vac/60Hz, 230Vac/50Hz Amperes: 4A @ 115Vac/2A @ 230Vac Watts: 310
PCS II	Operating Voltage: 115Vac/60Hz, 230Vac/50Hz Amperes: 2A @ 115Vac/1A @ 230Vac Watts: 160

3. WP/OIS Systems

<u>PROCESSOR MODEL</u>	<u>ELECTRICAL SPECIFICATIONS*</u>
System 5	Operating Voltage: 115Vac/60Hz, 230Vac/50Hz Amperes: 3A @ 115Vac/1.5A @ 230Vac Watts: 230
System 20/25/30	Operating Voltage: 115Vac/60Hz, 230Vac/50Hz Amperes: 3A @ 115Vac/1.5A @ 230Vac Watts: 230
OIS 105/115	Operating Voltage: 115Vac/60Hz, 230Vac/50Hz Amperes: 6A @ 115Vac/3A @ 230Vac Watts: 460
OIS 125/130	Operating Voltage: 115Vac/60Hz, 230Vac/50Hz Amperes: 2A @ 115Vac/1A @ 230Vac Watts: 155
OIS 125A/130A	Operating Voltage: 115Vac/60Hz, 230Vac/50Hz Amperes: 6A @ 115Vac/3A @ 230Vac Watts: 460
OIS 140/145	Operating Voltage: 115Vac/60Hz, 230Vac/50Hz Amperes: 3A @ 115Vac/1.5A @ 230Vac Watts: 230

\* All voltages  $\pm 10\%$ ; Hertz is  $\pm 1$  cycle.

**CHAPTER**

**5**

**STATIC**

## CHAPTER 5

## STATIC

## 5.1 ELECTROSTATIC DISCHARGE

This chapter provides a method for determining the susceptibility of a computer system to electrostatic (static) interference. It includes instructions on the use of the dc Hypot tester, procedures for static-testing CPUs and peripheral devices, and steps to be taken in case of low static immunity.

Static electricity is not only an annoyance to personnel, but can cause equipment malfunction. Minimizing or eliminating static is an important step in the elimination of many chronic system problems.

## 5.2 STATIC RELATED PROBLEMS

Static related problems have shown up in several forms including the following:

1. Random IOP lights.
2. System dropping into Control Mode "W".
3. System hanging with no lights or control mode
4. Intermittent disk faults.
5. Corruption of data files.

Generally, most static problems can be dealt with by proper grounding and cabling. If the system under test shows any of these symptoms or fails the HYPOT test procedure, refer to Paragraph 5.4.

## 5.3 ELIMINATING STATIC PROBLEMS IN THE WORK ENVIRONMENT

1. Ground the equipment cabinets and be sure that the computer is connected to a true earth ground. Water pipes in most new buildings do not provide a suitable earth ground.
2. Maintain room humidity at about 40%. This is particularly important in the winter months when buildings are heated, since heating dries the air and reduces the humidity significantly.

3. Select furniture with anti-static upholstery and metal wheels. Plastic upholstery builds up a charge when clothing moves over it and rubber wheels prevent static bleed-off through the floor covering. The discharge of this build-up to the system framework when the furniture or its occupant come into contact with the equipment can cause system malfunction.
4. Avoid installing equipment in a carpeted area. If carpeting must be used, it should be designed to minimize static electricity and should be treated with anti-static sprays as required.

#### 5.4 SHIELDING WANG EQUIPMENT

Wang has begun shipping equipment with static shielding as an integral part of the structure of the units. This equipment is designed with static immunity being a prime consideration. When re-assembling such equipment after servicing, do not compromise the integrity of the static shield. Ensure all screws and internal cable connections are tight and in place. Ensure that all chassis covers are seated properly and all external cables are secure and grounded if necessary. Ensure that all equipment chassis are connected to true earth grounds via the power cables.

In older model equipment especially, all peripherals should be equipped with static tested, shielded I/O cables. Additionally, on VS 60/80 systems, all cables except those running to serial devices should be grounded to the CPU by means of a new back panel (WLI #272-0011), which replaces the parallel device grounding panel. On all systems, all parallel cables should be grounded by means of the braided strap at the CPU end of the cable. All disk and tape cables should be clamped in the appropriate back-panel slots. The back-panel clamps must be in contact with the foil portion of the cable. The other cable end must be clamped to the appropriate disk drive in a similar manner, ensure that both cable ends are grounded to the respective devices. Shielding for peripherals is as follows:

1. Workstations and Printers
  - a. Parallel Devices--Static-tested, shielded I/O cables for 2246P workstations, 2221V, 2231V, 2281V, and 2263V Printers are distinguished by a six-inch braided ground strap attached to the cable shield three feet from the IOP connector end of the cable.

Cable numbers for the 2246P workstation are as follows:

<u>PART NUMBER</u>	<u>LENGTH IN FEET</u>
120-22VS-2	25
120-22VS-5	50
120-22VS-10	100
120-22VS-15	150
120-22VS-20	200
120-22VS-25	250
120-22VS-30	300
120-22VS-35	350
120-22VS-40	400
120-22VS-45	450
120-22VS-50	500

For 2221V, 2231V and 2263V Printers:

<u>PART NUMBER</u>	<u>LENGTH</u>
120-0185-1	15 ft

For 2281V Printers:

<u>PART NUMBER</u>	<u>LENGTH</u>
120-0186	15 ft

For 2261V Printers:

The 2261V Printer is shipped with a 12-ft I/O cable (WL #220-0184) permanently attached. This cable is NOT shielded.

## 2. Serial Devices

Refer to Appendix A for a list of all appropriate cable numbers.

## 3. Disk Drives

Static-tested, shielded I/O cables for 2260V, 2265-1, 2265V-2 and 2280V disk drives are distinguished by the copper tape that covers both sides of these flat cables. A plastic sleeve surround the cable thus insulating the copper tape

For 2260V (Hawk) Disk Drives:

<u>PART NUMBER</u>	<u>LENGTH</u>
220-0236	10 ft, w/terminator (single drive)
220-0169-1	10 ft, CPU-to-disk (daisy chain)
220-0187-1	10 ft, w/terminator (daisy chain)



For 2265V-1, 2265V-2 and 2280V Disk Drives:

<u>PART NUMBER</u>	<u>LENGTH</u>
220-3041-6	15 ft, "A" (single drive)
220-3033-8	15 ft, "B" (single drive)
220-3031-1	10 ft, "A" (daisy chain)
220-3033-19	24 ft, "B" (daisy chain)

4. Tape Drives

For 2209V, 2209V-1, 2209V-2 Tape Drives:

<u>PART NUMBER</u>	<u>LENGTH</u>
220-0168-1	10 ft, CPU/Formatter

After ensuring that shielded cables are installed, the following steps should be performed to further prevent static build-up.

1. Check to see that all ground straps on the CPU (I/O cables, straps to the front and rear of CPU) are connected and tight. Ensure that all ground lugs in the power supply and connectors P4 and P5 (motherboard power supply harness) are tight.
2. Check for excessive paper static build up on printers as follows:
  - a. 22673V-1, 2263V-2 5570, 5571:  
The static bar assembly has caused problems in the past. Refer to CSNL 101 for procedure to check and replace static bar and transformer.
  - b. 5573, 5574:  
Some Band Printers have been generating excessive paper static. If this is happening, call TAC (Ext. 6111) and they will refer the problem to the Printer Support Group.
3. Some serial cables have been shipped with poor solder joints in the connectors. This greatly reduces their static immunity. If the connectors are suspect, either resolder the old connector or replace it with the new crimp-on BNC (WLI# 350-2114) and TNC (WLI# 350-2113) connectors. Refer to PSN I.B.0-1 (729-0864) for crimp-on connector installation instructions.

Because static electricity is much more prevalent during the cold, dry months of the fall and winter, it is recommended that all systems be tested for static immunity and upgraded if necessary before the onset of winter.

If static problems persist after following this guide, call the Home Office Technical Assistance Center (TAC Ext. 6111) for further assistance.

#### 5.4.1 TESTING AND INSTALLING THE VS 60/80 GROUND STRAP

On VS 60/80 Systems, check the power supply for the presence of a braided ground strap (WLI #220-1156) between the  $\pm 0V$  Bus and the power supply chassis as follows:

1. Switch the ac circuit breaker OFF.
2. Unplug the ac power cord from the wall socket.
3. Remove the top and rear panel.
4. Unplug Floppy Disk Drive power harness P6.
5. Unplug motherboard power harnesses P4 and P5.
6. Using a digital voltmeter (DVM), check for continuity (zero ohms) between the power supply chassis and pin 2 of power supply connector J4 (newer units) or pin 2 of the fuse block that P4 was plugged into (older units). A reading of infinity indicates the ground strap is missing.
7. If the ground strap is present, re-assemble the CPU by performing steps 1 through 5 in reverse order. If the ground strap is missing, install it as follows:
  - a. Remove the two retaining bolts holding the bottom rear flange of the power supply assembly to the cabinet frame.
  - b. Pull the entire power supply assembly from the cabinet by sliding it rearwards along the supporting frame rails.
  - c. Position the power supply assembly on the floor so that it is readily accessible. (Do not damage the assembly.)
  - d. Remove the screw from the bottom of the power supply  $\pm 0V$  bus bar as shown in Figure 1. Attach the ground strap to the screw and re-install the screw in the power supply  $\pm 0V$  bus bar.
  - e. Place the remaining end of the ground strap over the bolt shown in Figure 1 and secure the strap with a 10/32" nut (WL #652-6002).
  - f. Re-install the power supply and return the VS to working order.

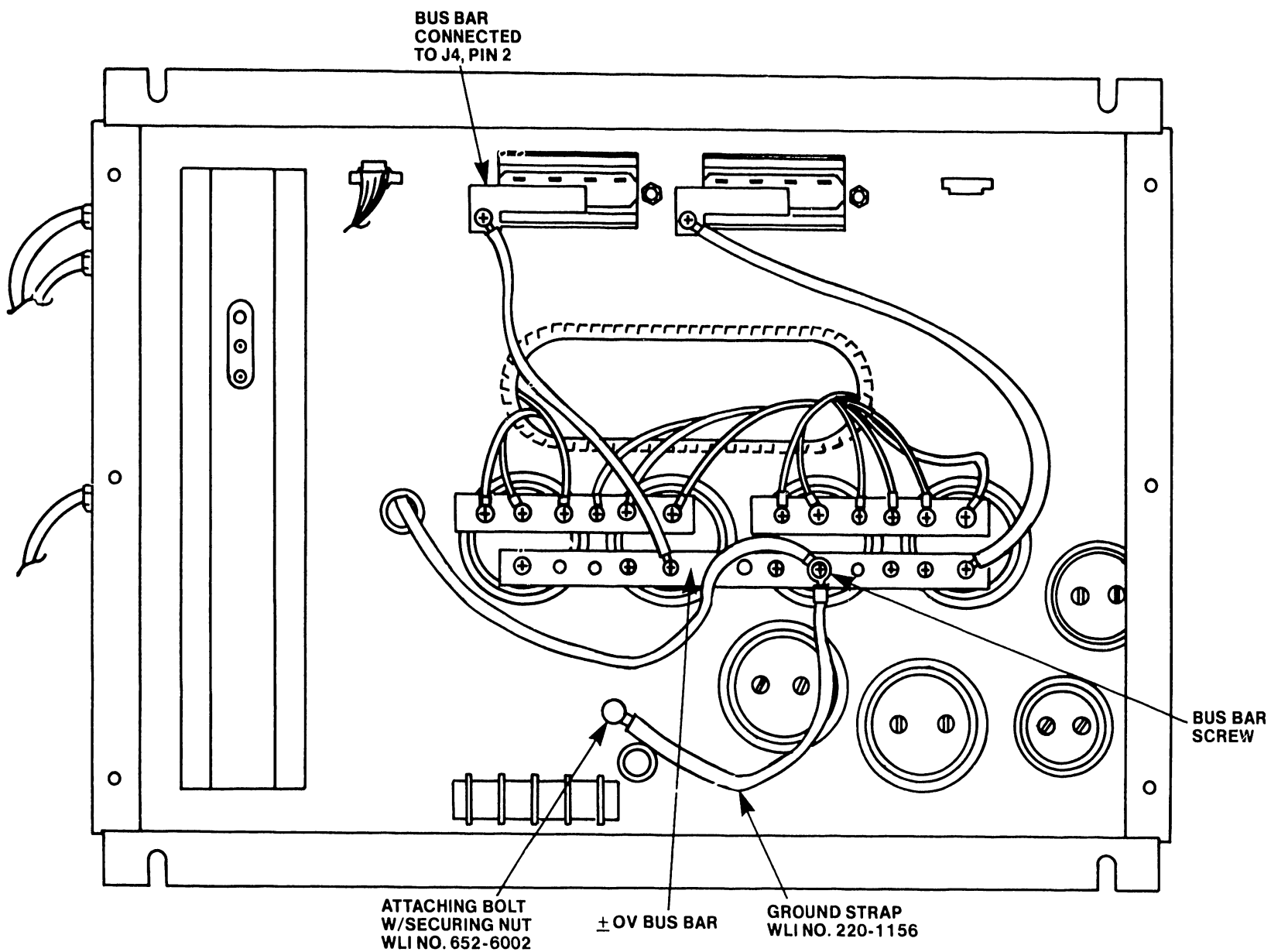

FIGURE 5-1 VS 60/80 POWER SUPPLY (Bottom View)

## 5.5 USE OF THE HI-POT TESTER FOR STATIC TESTING

Field Electrostatic Discharge (ESD) testing determines the susceptibility of Wang systems to static electricity. Testing is conducted during normal system operation. A successful ESD test is one that does not interfere with normal system operation at 2500 Vdc. If a malfunction occurs at or below 2500 Vdc, take appropriate steps to rectify the problem.

---

### **\*\*CAUTION\*\***

Do NOT use customer packs when performing ESD tests. There is a danger of corrupting VTOC or data files. Use only scratch packs.

---

### NOTE

Perform all tests with fully assembled equipment. All covers must be in place, and the system must be operating.

Operation of the ESD tester is not complicated. To use it for checking equipment static susceptibility, proceed as follows:

1. Place the tester in a convenient location.
2. Verify the on/off switch is in the "OFF" position and insert the ac power plug into an appropriate power source.
3. Ensure that all equipment is properly connected to a common ground.
4. With a DMM or similar device, check for continuity between the ESD ac power ground, the black ESD test lead, and the ac power ground of the unit under test. These points must be electrically the same. This MUST be determined before ESD testing is done.

---

### **\*\*\*WARNING\*\*\***

Incorrect grounding between the test unit and the ESD tester can result in serious injury to the user.

5. Connect the black test lead of the ESD tester to the ac power ground of the unit under test.
6. Power-up the ESD tester and set it to 500 Vdc.
7. With the Red (hot) lead, discharge the tester to the unit under test at various locations THREE times at each location while observing system operation. (Hi-pot test lights will blink signifying discharge.) Perform this test in 500 volt increments until a reading of 2500 Vdc is reached on the tester.
8. Test System Software by displaying the Main Menu and holding down the space bar on a workstation while performing the ESD test. Failures while the System Software is tested will result in System IPL.

## 5.5.1 STATIC TESTING VS SYSTEMS

Bring the VS system up using a scratch pack. Run WSTEST from the command console and SYSTEM from another workstation. This will provide a constantly changing screen to monitor for system hangup and will send data up and down the disk cables. Perform the following diagnostic software test after performing the System Software test in Paragraph 5.5.

1. CPU: Set up the dc ESD unit as instructed in Paragraph 5.5 (initial setting is 500 Vdc.). Using the red (hot) lead, touch the CPU cabinet in various locations, i.e. side panel, front panel, cable connectors, etc. (three discharges per location). Observe system reaction during each discharge. If failures occur, the CPU is susceptible to static discharge. Take necessary corrective measures.
2. Disk Drives: Touch the red lead of the ESD to various places on the cabinet of each disk drive. Check for CP, IOP, or lit fault lights. Make sure the system is still running.
3. Workstations: Run WSTEST from the workstation to be tested. Touch the red lead of the ESD unit to the keyboard frame, cable connectors, and side screws. DO NOT use either the contrast or brightness knobs as discharge points, damage to the CRT may occur. Check for workstation hangup or system failure.
4. Printers: Exercise the printer under test by running PRTEST. While the printer is running, touch the red lead of the ESD unit to various spots on the cabinet, data link cables, etc. DO NOT discharge through any internal parts, i.e. carriage assemblies, platens, etc. Check for proper printing and system operation.
5. Tape Drives: Run TPTEST 42. While the unit is running, touch the red lead to various places on the tape drive cabinet. DO NOT discharge through internal parts. Check for proper tape and system operation.

Repeat the above procedure in 500 volt increments until 2500 Vdc is reached on the tester. If the system passes the above tests at 2500 Vdc, no further action is needed. If failures occur, corrective action must be taken. Refer to Paragraph 5.4 of this document for some corrective procedures.

## 5.5.2 STATIC TESTING 2200 SYSTEMS

Bring the system up using a scratch pack. Run BASIC DIAGNOSTICS from the

master terminal. This provides a constantly changing screen to monitor for system hangups and sends data over the disk cables. Perform the following diagnostic software test after the System Software test in Paragraph 5.5.

1. CPU: Set up the dc ESD unit as instructed in Paragraph 5.5 (initial setting is 500 Vdc). Using the red (hot) lead, touch the CPU cabinet in various locations, i.e. side panel, front panel, cable connectors, etc (three discharges per location). Observe system reaction during each discharge. If failures occur, the CPU is susceptible to static discharge. Take necessary corrective measures.
2. Disk Drives: Touch the red lead of the ESD to various places on the cabinet of each disk drive. Check for CP, I/O errors, or lit fault lights. Make sure the system is still running.
3. Workstations: Run 2236DE TEST (Peripheral Diagnostics) from the workstation to be tested. Touch the red lead of the ESD unit to the keyboard frame, cable connectors, and side screws. DO NOT use either the contrast or brightness knobs as discharge points, damage to the CRT may occur. Check for workstation or system failures.
4. Printers: Exercise the printer under test by running PRINTER TEST (Peripheral Diagnostics). While the printer is running, touch the red lead of the ESD unit to various spots on the cabinet, to the data link cables, etc. DO NOT discharge through any internal parts, i.e. carriage assemblies, platens, etc. Check for proper printing and system operation.
5. Tape Drives: Run TAPE TEST (Mass Storage Diagnostics). While the unit is running, touch the red lead to various places on the tapedrive cabinet. DO NOT discharge through any internal parts. Check for proper tape and system operations.

Repeat the above procedure in 500 volt increments until 2500 Vdc is reached on the tester. If the system passes the above tests at 2500 Vdc, no further action is needed. If failures occur, corrective action must be taken. Refer to Paragraph 5.4 of this document for some corrective procedures.

### 5.5.3 STATIC TESTING WP/OIS SYSTEMS

Bring the system up and generate a glossary to exercise the workstation and CPU. Ensure that the glossary provides a constantly changing screen to

monitor for system hangup and causes data to be sent over the disk cables. Perform the following test after the System Software test in Paragraph 5.5.

---

\*\*\*CAUTION\*\*\*

Ensure that all customer information has been properly backed up before proceeding with this test. If the system FAILS the static test, significant loss of stored data can occur.

1. CPU: Set up the dc ESD unit as instructed in Paragraph 5.5.1 (initial setting is 500 Vdc). Using the red (hot) lead, touch the CPU cabinet in various locations, i.e. side panel, front panel, cable connectors, etc. (three times per location). Observe system reaction during each discharge. If failures occur, the CPU is susceptible to static discharge. Take necessary corrective measures.
2. Disk Drives: Touch the red lead of the ESD to various places on the cabinet of each disk drive (three times per location). Check for CP errors or lit fault lights. Ensure that the system is still running.
3. Workstations: With the glossary still running, touch the red lead of the ESD unit to the workstation keyboard frame, cable connectors, and side screws (three times per location). DO NOT use either the contrast or brightness knobs as discharge points, damage to the CRT may occur. Check for workstation hangups and system failures.
4. OUTPUT DEVICES: Exercise the device under test by queing a document for the device. While the device is running, touch the red lead of the ESD unit to various spots on the cabinet, data link cables, etc. (three times per location). DO NOT discharge through any internal parts, i.e. carriage assemblies, platens, etc. Check for proper device and system operation.

---

\*\*\*CAUTION\*\*\*

If a typesetter is part of the WP/OIS system under test, DISCONNECT it from the system. DO NOT subject the Wang typesetter to static testing at this time.

If the system passes the above test at 2500 Vdc no further action is needed. If any part fails, proper steps must be taken to rectify the problem. Refer to Paragraph 5.4 of this document for some corrective procedures.

**APPENDIX  
A  
VS CABLING  
IDENTIFICATION**



APPENDIX A  
VS CABLING IDENTIFICATION

<u>UNIT</u>	<u>CABLE PART #</u>	<u>LENGTH (feet)</u>	<u>IDENTIFICATION</u>
2246P	120-22VS-2	25	IOP to Workstation
2246P	120-22VS-5	50	IOP to Workstation
2246P	120-22VS-10	100	IOP to Workstation
2246P	120-22VS-15	150	IOP to Workstation
2246P	120-22VS-20	200	IOP to Workstation
2246P	120-22VS-25	250	IOP to Workstation
2246P	120-22VS-30	300	IOP to Workstation
2246P	120-22VS-35	350	IOP to Workstation
2246P	120-22VS-40	400	IOP to Workstation
2246P	120-22VS-45	450	IOP to Workstation
2246P	120-22VS-50	500	IOP to Workstation
2260V	220-0169	10	IOP to 1st 10 MB Drive (w/o Terminator)
2260V	220-0188	10	IOP to 1st 10 MB Drive (w/ Terminator)
2260V	220-0170	5	10 MB Drive to 10 MB Drive (w/o Terminator)
2260V	220-0187	5	10 MB Drive to 10 MB Drive (w/ Terminator)
2221V	220-0185	15	IOP to Printer
2231V1	220-0185-1	15	IOP to Printer
2231V2	220-0185-1	15	IOP to Printer
2261V	220-0184	15	IOP to Printer
2263V1	220-0185	15	IOP to Printer
2263V2	220-0185	15	IOP to Printer
2281V	220-0186	15	IOP to Printer
2231V	120-22VS-2P	25	IOP to Printer
2261V	120-22VS-2P	25	IOP to Printer
2281V	120-22VS-2P	25	IOP to Printer
2231V	120-22VS-5P	50	IOP to Printer
2261V	120-22VS-5P	50	IOP to Printer
2281V	120-22VS-5P	50	IOP to Printer
2221V	120-22VS-2	25	IOP to Printer
2263V	120-22VS-2	25	IOP to Printer
2221V	120-22VS-5	50	IOP to Printer
2263V	120-22VS-5	50	IOP to Printer

DISK DRIVE CABLES

<u>CABLE TYPE</u>	<u>LENGTH</u>	<u>WLI #</u>	<u>DISK DRIVE UNITS</u>
A	10'	220-3031-1	300, 80, Px
A	15'	220-3041-6	300, 80, Px
B	15'	220-3033-18	300, 80, Px
B	24'	220-3033-19	300, 80, Px
A	15'	220-3041-3	old style 80
B	15'	220-3033-12	old style 80
B	24'	220-3033-13	old style 80
2209A JKT	10'	220-0168-1	Kennedy Tape

When installing these cables, both ends of the shielding must be clamped to ground on the unit it is attached to.

## COAXIAL CABLE PART NUMBERS FOR ALL SYSTEMS

<u>PART NUMBER</u>	<u>LENGTH (feet)</u>	<u>PART NUMBER</u>	<u>LENGTH (feet)</u>
120-2300-1	50	120-2300-21	1050
120-2300-2	100	120-2300-22	1100
120-2300-3	150	120-2300-23	1150
120-2300-4	200	120-2300-24	1200
120-2300-5	250	120-2300-25	1250
120-2300-6	300	120-2300-26	1300
120-2300-7	350	120-2300-27	1350
120-2300-8	400	120-2300-28	1400
120-2300-9	450	120-2300-29	1450
120-2300-10	500	120-2300-30	1500
120-2300-11	550	120-2300-31	1550
120-2300-12	600	120-2300-32	1600
120-2300-13	650	120-2300-33	1650
120-2300-14	700	120-2300-34	1700
120-2300-15	750	120-2300-35	1750
120-2300-16	800	120-2300-36	1800
120-2300-17	850	120-2300-37	1850
120-2300-18	900	120-2300-38	1900
120-2300-19	950	120-2300-39	1950
120-2300-20	1000	120-2300-40	2000
	350-2076	TNC to TNC Adapter	
	350-2077	BNC to BNC Adapter	

A quick method of determining the part number for the desired length of coaxial cable is as follows:

1. Determine length of cable required and round up to the nearest multiple of 50--e.g., if measured length is 1638, round up to 1650; if length is 1784, round up to 1800. Do NOT exceed the maximum cable length of 2000' when using this method.
2. After obtaining the rounded-up figure, DIVIDE this figure by 50--i.e, 1650 divided by 50 equals 33. The answer after performing the division added after 120-2300 is the part number for the desired cable length--120-2300-33 is the part number for coaxial cable 1650' long.

**APPENDIX**

**B**

**WORLD-**

**WIDE**

**POWER**

APPENDIX B  
WORLDWIDE POWER\*

This list shows normally available single and three-phase power. Most areas are regulated  $\pm$  10 percent in voltage and  $\pm$  percent in frequency.

! AFRICA	! FREQU. IN HZ	! NO. OF PHASES	! VOLTAGE (S)	! NO. OF WIRES
! Algeria 1	! 50	! 1,3	! 127/220,220/380	! 2,4
! Azores	! 50	! 1,3	! 220/380	! 2,3,4
! Canary Islands 2,17	! 50	! 1,3	! 127/220,220/380	! 2,3,4
! Congo, Rep. of 2,3	! 50	! 1,3	! 220/380	! 2,4
! Dahomey	! 50	! 1,3	! 220/380	! 2,4
! Egypt 17	! 50	! 1,3	! 220/380	! 2,4
! Ethiopia	! 50	! 1,3	! 220/380	! 2,3,4
! Ghana 17	! 50	! 1,3	! 220/380	! 2,4
! Guinea 17	! 50	! 1,3	! 220/440	! 2,3,4
! Ivory Coast	! 50	! 1,3	! 220/380	! 2,3,4
! Kenya 3,4	! 50	! 1,3	! 220/380	! 2,4
! Liberia	! 60	! 1,3	! 240/415	! 2,4
! Libya 2,5,17	! 50	! 1,3	! 120/240,120/208	! 2,3,4
! Malagasy Rep.	! 50	! 1,3	! 127/220	! 2,4
! Mauritania 17	! 50	! 1,3	! 127/220,220/380	! 2,4
! Morocco 2,3	! 50	! 1,3	! 220	! 2,3
! Mozambique 3	! 50	! 1,3	! 115/200	! 2,4,5
! Niger 17	! 50	! 1,3	! 220/380	! 2,3,4
! Nigeria 2	! 50	! 1,3	! 220/380	! 2,3,4
! Rhodesia	! 50	! 1,3	! 110/220	! 2,4
! Rwanda	! 50	! 1,3	! 220/440	! ---
! Senegal 17	! 50	! 1,3	! 220/380	! 2,4
! Sierra Leone 17	! 50	! 1,3	! 240/415	! 2,3,4
! Somalia	! 50	! 1,3	! 127/220,220/380	! 2,4
! Sudan 3	! 50	! 1,3	! 240/415	! 2,4
! Tunisia 2	! 50	! 1,3	! 127/220,220/380	! 2,4
! Uganda 2,3	! 50	! 1,3	! 240/415	! 2,4
! South Africa	! 50	! 1,3	! 220/380	! 2,4
! Upper Volta	! 50	! 1,3	! 220/380	! 2,4
! Tanzania 2,3	! 50	! 1,3	! 230/400	! 2,3,4

\* Data obtained from Electric Current Abroad, U.S. Department of Commerce, May 1965 edition.

! ASIA	! FREQU. IN HZ	! NO. OF PHASES!	! VOLTAGE (S)	! NO. OF WIRES !
! Burma 17	! 50	! 1,3	!127/220,220/380!	! 2,4 !
! Cambodia 7,17	! 50	! 1,3	!220/380	! 2,3,4 !
! China,			!	!
! People's Rep. 17	! 50	! 1,3	!127/220,220/380!	! 2,3,4 !
! Hong Kong	! 50	! 1,3	!220/380	! 2,4 !
! India	! 50	! 1,3	!220/380	! 2,4 !
! Indonesia 2,3,9,17	! 50	! 1,3	!220/380	! 2,4 !
! Iran	! 50	! 1,3	!220/380	! 2,3,4 !
! Iraq 3	! 50	! 1,3	!220/380	! 2,4 !
! Israel 2,3	! 50	! 1,3	!220/440	! 2,3,4 !
! Japan	! 50/60	! 1,3	!220/380	! 2,3,4 !
! Jordan 2,3	! 50	! 1,3	!220/380	! 2,4 !
! Korea 2	! 60	! 1,3	!240/415	! 2,4 !
! Kuwait	! 50	! 1,3	!120/240,120/208!	! 2,3,4 !
! Laos	! 50	! 1,3	!127/220	! 2,4 !
! Lebanon 2,17	! 50	! 1,3	!127/220,220/380!	! 2,4 !
! Maco	! 50	! 1,3	!220	! 2,3 !
! Malaysia 2,3	! 50	! 1,3	!115/200	! 2,4,5 !
! Pakistan 2,17	! 50	! 1,3	!220/380	! 2,3,4 !
! Phillippines 2	! 50	! 1,3	!220/380	! 2,3,4 !
! Okinawa 2	! 50	! 1,3	!110/220	! 2,4 !
! Saudi Arabia 10,11	! 50	! 1,3	!220/440	! --- !
! Singapore 2	! 50	! 1,3	!220/380	! 2,4 !
! Syria	! 50	! 1,3	!240/415	! 2,3,4 !
! Taiwan 2	! 50	! 1,3	!127/220,220/380!	! 2,4 !
! Thailand	! 50	! 1,3	!240/415	! 2,4 !
! Turkey 2	! 50	! 1,3	!127/220,220/380!	! 2,4 !
! USSR 12	! 50	! 1,3	!240/415	! 2,4 !
! Vietnam 13,17	! 50	! 1,3	!220/380	! 2,4 !

! AUSTRALIA AND THE	!	!	!	!
! PACIFIC ISLANDS	! FREQU. IN HZ	! NO. OF PHASES!	! VOLTAGE (S)	! NO. OF WIRES !
! Australia 2,3	! 50	! 1,3	!127/220,220/380!	! 2,4 !
! Fiji	! 50	! 1,3	!220/380	! 2,3,4 !
! New Caledonia	! 50	! 1,3	!127/220,220/380!	! 2,3,4 !
! New Zealand 2,3	! 50	! 1,3	!220/380	! 2,4 !
! Tahiti 17	! 50	! 1,3	!220/380	! 2,4 !

! EUROPE	! FREQU. IN HZ	! NO. OF PHASES!	! VOLTAGE (S)	! NO. OF WIRES !
! Austria	! 50	! 1,3	!220/380,220/380!	! 2,4 !
! Belgium 2,3	! 50	! 1,3	!127/220,220/380!	! 2,3,4 !
! Bulgaria	! 50	! 1,3	!220/380,220/380!	! 2,3,4 !
! Channel Isl.	! 50	! 1,3	!240/415	! 2,4 !
! Cyprus 2,3	! 50	! 1,3	!240/415	! 2,4 !
! Czechoslovakia	! 50	! 1,3	!220/380	! 2,3,4 !
! Denmark	! 50	! 1,3	!220/380	! 2,3,4 !
! Finland	! 50	! 1,3	!220/380	! 2,4 !
! France	! 50	! 1,3	!127/220,220/380!	! 2,4 !
! Germany 2,3	! 50	! 1,3	!220/380	! 2,4 !
! Gibraltar	! 50	! 1,3	!240/415	! 2,4 !
! Great Britain 3	! 50	! 1,3	!240/415	! 2,4 !
! Greece	! 50	! 1,3	!220/380	! 2,4 !
! Hungary	! 50	! 1,3	!220/380	! 2,4 !
! Iceland	! 50	! 1,3	!220/380	! 2,3,4 !
! Ireland 2,3	! 50	! 1,3	!220/380	! 2,4 !
! Italy	! 50	! 1,3	!217/220,220/380!	! 2,3,4 !
! Luxembourg 2,3	! 50	! 1,3	!120/208,220/380!	! 3,4,5 !
! Majorca 2	! 50	! 1,3	!127/220,220/380!	! 2,3,4 !
! Malta 2,3	! 50	! 1,3	!240/415	! 2,4 !
! Monaco	! 50	! 1,3	!127/220,220/380!	! 2,4 !
! Netherlands 2	! 50	! 1,3	!220/380	! 2,4 !
! Norway	! 50	! 1,3	!230	! 2,3 !
! Poland 17	! 50	! 1,3	!220/380	! 2,4 !
! Portugal 2	! 50	! 1,3	!220/380	! 2,3,4 !
! Romania	! 50	! 1,3	!220/380	! 2,4 !
! Spain 14	! 50	! 1,3	!127/220,220/380!	! 2,3,4 !
! Sweden 2,3	! 50	! 1,3	!220/380	! 2,4 !
! Switzerland 2,3	! 50	! 1,3	!220/380	! 2,3,4 !
! USSR 12	! 50	! 1,3	!127/220	! --- !
! Yugoslavia 17	! 50	! 1,3	!220/380	! 2,4 !

! NORTH AMERICA	! FREQU. IN HZ	! NO. OF PHASES!	! VOLTAGE (S)	! NO. OF WIRES !
! Bahamas	! 60	! 1,3	!120/240,120/208!	! 2,3,4 !
! Barbados	! 50	! 1,3	!120/208,110/200!	! 2,3,4 !
! Bermuda	! 60	! 1,3	!115/230	! 2,3,4 !
! Canada 2,15	! 60	! 1,3	!120/240	! 3 !
! Costa Rica	! 60	! 1,3	!120/240	! 2,3,4 !
! Greenland	! 50	! 1,3	!220/380	! 2,3,4 !
! Haiti 17	! 60	! 1,3	!110/220	! 2,3,4 !
! Honduras 17	! 60	! 1,3	!110/220	! 2,3 !
! Jamaica	! 50	! 1,3	!110/220	! 2,3,4 !
! Mexico	! 60	! 1,3	!127/220	! 2,3,4 !
! Netherlands	!	!	!	!
! Antillies 2,3,7	! 50	! 1,3	!127/220	! 2,3,4 !
! Puerto Rico	! 60	! 1,3	!120/240	! 2,3,4 !
! Trinidad 2	! 60	! 1,3	!115/230,230/400!	! 2,3,4 !
! USA	! 60	! 1,3	!115/220	! 2,3,4 !
! Virgin Islands	! 60	! 1,3	!120/240	! 2,3,4 !

SOUTH AMERICA	FREQU. IN HZ	NO. OF PHASES	VOLTAGE (S)	NO. OF WIRES
! Argentina 16	! 50	! 1,3	!220/380,220/380!	! 2,4
! Bolivia 2,3	! 50	! 1,3	!127/220,220/380!	! 2,4
! Brazil 2,17	! 60	! 1,3	!220/380,220/380!	! 2,3,4
! Chile	! 50	! 1,3	!240/415	! 2,3,4
! Dominican Rep.	! 60	! 1,3	!240/415	! 2,3
! Ecuador	! 60	! 1,3	!220/380	! 2,3,4
! El Salvador 2	! 60	! 1,3	!220/380	! 2,3
! Fr. Guiana 2,3,17	! 50	! 1,3	!220/380	! 2,3,4
! Guadeloupe	! 50	! 1,3	!127/220,220/380!	! 2,3,4
! Guatemala 17	! 60	! 1,3	!220/380	! 2,3,4
! Guyana 6	! 50	! 1,3	!240/415	! 2,3
! Nicaragua	! 60	! 1,3	!240/415	! 2,3,4
! Panama	! 60	! 1,3	!220/380	! 2,3
! Paraguay 17	! 50	! 1,3	!220/380	! 2,3
! Peru	! 60	! 1,3	!220/380	! 2,3
! St. Kitts	! 60	! 1,3	!220/380	! 2,4
! Surinam	! 60	! 1,3	!217/220,220/380!	! 2,3,4
! Uruguay	! 50	! 1,3	!120/208,220/380!	! 2,3
! Venezuela	! 60	! 1,3	!127/220,220/380!	! 2,3,4
! Columbia 17	! 60	! 1,3	!240/415	! 2,3,4

- NOTE 1: Voltage regulators are advisable for all delicate electrical equipment due to substantial voltage fluctuations
- NOTE 2: The neutral wire of the secondary distribution system is grounded.
- NOTE 3: A grounding conductor is required in the electrical cord attached to appliances.
- NOTE 4: Voltage varies between  $\pm 6\%$ .
- NOTE 5: Electric current is now continuous in most cities and large towns.
- NOTE 6: Plans to standardize current at 60Hz and domestic voltage at 115/230 Vac, 2-and 3-wire single phase and 480 V, 3-phase, 3-wire industrial.
- NOTE 7: Data based on information obtained in 1967.
- NOTE 8: The voltage is gradually being converted from 127 to 220V.
- NOTE 9: Conversion to 220/380 Vac has been started in Djakarta, other parts of the country will follow.
- NOTE 10: Grounding conductors are not required on appliances and many houses are wired for a separate ground.
- NOTE 11: Power supply being standardized at 60 Hz, 127/220V.
- NOTE 12: Voltage variations sufficient to damage electrical appliances are not uncommon.
- NOTE 13: The electric utility system is to be standardized at 3-phase, 220/380 V, 4-wires, wye. However, it will be several years before all of the system will be changed over to this voltage.
- NOTE 14: Grounding conductor is required for 220/380V.
- NOTE 15: Three phase, 4-wire systems such as 120/208 are available.
- NOTE 16: Voltage is variable and may drop very low during peak hours.
- NOTE 17: Frequency is unstable with resulting possible service interruptions.

NUMBER OF WIRES TO THE CONSUMER - The number of wires that may be utilized by the consumer is shown. Normally, a single phase, 220/380V system or 127/220 V system will have two wires if only the lower voltage is available (one-phase wire and the neutral). It will have three wires if both the higher and lower voltages are available (two-phase wires and the neutral) and where three-phase motors will be utilized, four wires will be available for the higher voltage (the three-phase wires and the neutral wire).

FREQUENCY - Shown in number of Hertz (cycles) per second. Even if voltages are similar, 60 Hz US clock or phonograph will not function properly on 50Hz.



**APPENDIX**

**C**

**VOLTAGE**

**RANGES**

APPENDIX C  
VOLTAGE RANGES

COUNTRY	VOLTAGE TOLERANCE (%)	COUNTRY	VOLTAGE TOLERANCE (%)
Argentina	+10	New Delhi	+6
Australia	+6	Iran	+15
Austria	+5	Iraq	*
Bahamas	*	Ireland (Northern)	+6
Bangladesh	+5	Ireland (Republic of)	*
Belgium	+5 (day) +10 (night)	Israel	+6
Bermuda	+5	Italy	+5 (urban) +10 (rural)
Bolivia	+5	Japan (East) (2)	+10
Brazil	*	Japan (West) (2)	+10
Bulgaria	+5	Luxembourg	+5 to 10
Canada	+4	Mexico	+6
	-8.3	Netherlands	+6
Columbia	+10	Netherland	*
Costa Rica	*	Antilles	
Czechoslovakia	+10	New Guinea	+5
Denmark	+10	New Zealand	+5
Dominican Republic	*	Norway	+10
Egypt (AR)	+10	Peru	*
Finland	+10	Phillippines	+5
France	+10	Portugal	+10
Germany (FR)	+10	Puerto Rico	+10
Germany (DDR)	+5	Singapore	+3
Greece	+5	South Africa	+5
Hong Kong (and Kowloon)	+6	Spain	+7
Hugary	+5	Sweden	+10
	-10	Switzerland	+10
Iceland	*	Turkey	+10
India (2) (Bombay)	+4		

\*Denotes information not available.

COUNTRY	VOLTAGE TOLERANCE (%)	COUNTRY	VOLTAGE TOLERANCE (%)
United Arab Emirates	+2 to 3	Miami (Florida)	+5
Dubai	*	New York (New York)	*
Abu Dhabi	*	Pittsburgh (Pennsylvania)	+5 (lighting) +10 (power)
United Kingdom (excluding Northern Ireland)	+6	Portland (Oregon)	*
Uruguay	+6	San Francisco (California)	+5
USA (2) (Charlotte N.C.)	+5	Toledo (Ohio)	+5
Detroit (Michigan)	-2.5 +4 -6.6	USSR	*
Los Angeles (California)	+5	Venezuela	*

\* Denotes information not available.

**APPENDIX  
D  
PRODUCT  
INFORMATION  
SHEETS**

**PRODUCT INFORMATION SHEET**

<u>DIMENSIONS</u>	<u>Inches</u>	<u>Centimeters</u>
WIDTH	20.4	51.8
HEIGHT	27.0	68.6
DEPTH	30.0	76.2

<u>NET WEIGHT</u>	<u>Pounds</u>	<u>Kilograms</u>
	160	72.6

<u>SERVICE CLEARANCES</u>	<u>Inches</u>	<u>Centimeters</u>
FRONT	12	30.5
REAR	30	75.0
LEFT	6	15.2
RIGHT	6	15.2
TOP	12	30.5

<u>POWER REQUIREMENTS</u>	<u>115V/60Hz</u>	<u>230V/50Hz</u>
AMPS	3.0 (SB)	1.5 (SB)
WATTS		230
DEDICATED CIRCUIT		YES

<u>HEAT OUTPUT (MAX)</u>	<u>Btu/hr</u>	<u>Kcal/hr</u>
	1,050	264.6

<u>CABLE LENGTH (MAX)</u>	<u>Feet</u>	<u>Meters</u>
POWER	10	3.1
DATA	-	-

NOTES

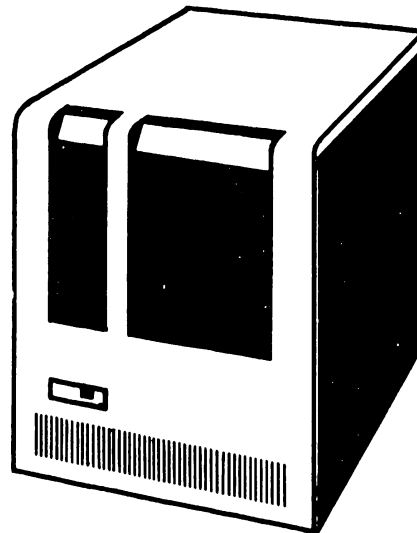
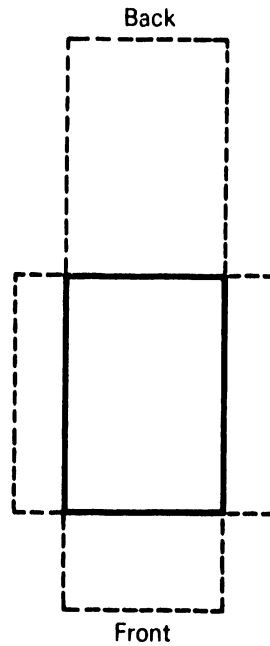

LVP CENTRAL PROCESSOR

2200LVP

PRODUCT INFORMATION SHEET

<u>DIMENSIONS</u>	<u>Inches</u>	<u>Centimeters</u>
WIDTH	21.5	54.6
HEIGHT	12.0	30.5
DEPTH	26.0	66.0

<u>NET WEIGHT</u>	<u>Pounds</u>	<u>Kilograms</u>
	75	34.1

<u>SERVICE CLEARANCES</u>	<u>Inches</u>	<u>Centimeters</u>
FRONT	26	66.0
REAR	6	15.2
LEFT	6	15.2
RIGHT	6	15.2
TOP	26	66.0

<u>POWER REQUIREMENTS</u>	<u>115V/60Hz</u>	<u>230V/50Hz</u>
AMPS	4.0 (SB)	2.0 (SB)
WATTS	307	
DEDICATED CIRCUIT	YES	

<u>HEAT OUTPUT (MAX)</u>	<u>Btu/hr</u>	<u>Kcal/hr</u>
	1,050	264.6

<u>CABLE LENGTH (MAX)</u>	<u>Feet</u>	<u>Meters</u>
POWER	10	3.1
DATA	-	-

NOTES

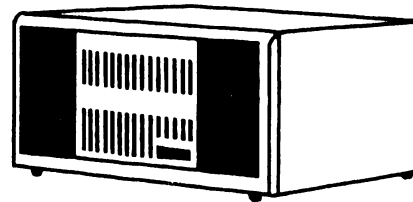
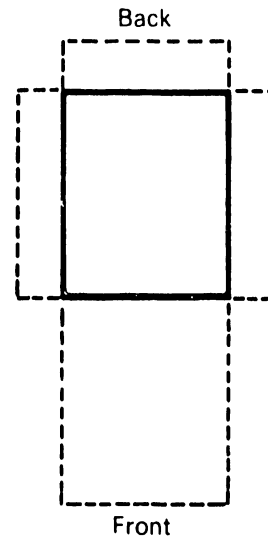

SVP CENTRAL PROCESSOR

2200SVP

PRODUCT INFORMATION SHEET

<u>DIMENSIONS</u>	<u>Inches</u>	<u>Centimeters</u>
WIDTH	20.4	51.8
HEIGHT (with stand)	36.0	91.4
DEPTH	32.6	82.8

<u>NET WEIGHT</u>	<u>Pounds</u>	<u>Kilograms</u>
	175	78.8

<u>SERVICE CLEARANCES</u>	<u>Inches</u>	<u>Centimeters</u>
FRONT	30	76.2
REAR	30	76.2
LEFT	24	61.0
RIGHT	12	30.5
TOP	39	99.1

<u>POWER REQUIREMENTS</u>	<u>115V/60Hz</u>	<u>230V/50Hz</u>
AMPS	8.0	4.0
WATTS	NOTE 1	
DEDICATED CIRCUIT		YES

<u>HEAT OUTPUT (MAX)</u>	<u>Btu/hr</u>	<u>Kcal/hr</u>
	NOTE 2	

<u>CABLE LENGTH (MAX)</u>	<u>Feet</u>	<u>Meters</u>
POWER DATA	8 NOTE 3	2.5

NOTES

1. 250W standing  
1900W start-up  
950W running
2. 1050 Btu/hr standing (264.6 kcal)  
2150 Btu/hr running (541.8 kcal)
3. 15 ft (4.6 m) cable  
to disk controller board in DPU  
15 ft (4.6 m) to previous 2280  
24 ft (7.3 m) to last drive

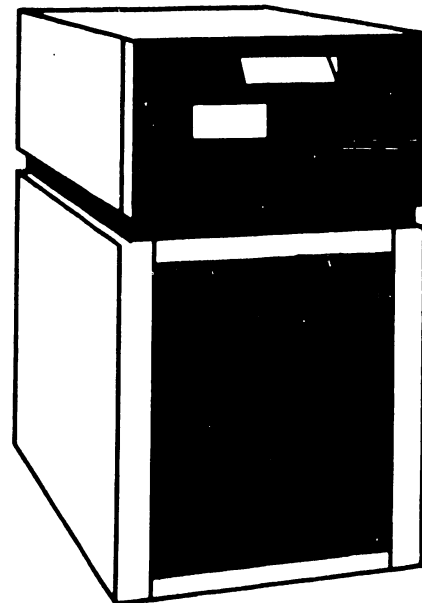
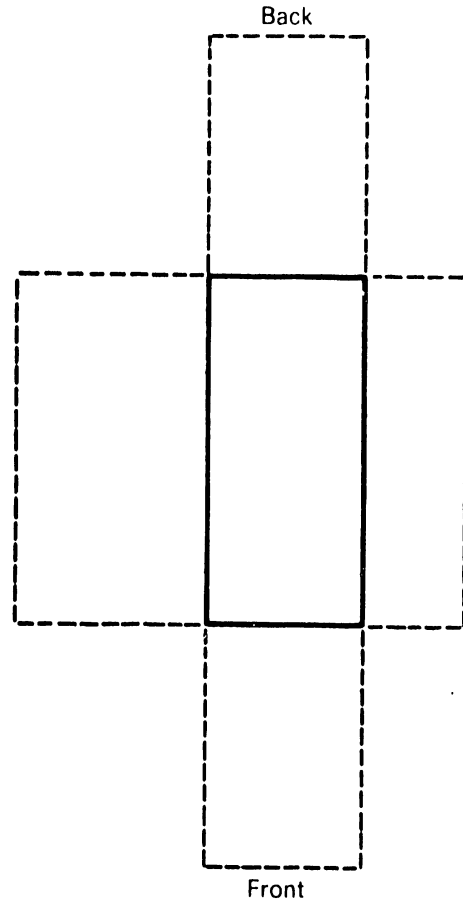

FIXED/REMOVABLE DISK DRIVE

2280-1, -2, -3; 2280N-1, -2 -3; 2280V-1, -2, -3

PRODUCT INFORMATION SHEET

<u>DIMENSIONS</u>	<u>Inches</u>	<u>Centimeters</u>
WIDTH	25.0	63.5
HEIGHT	14.5	36.8
DEPTH	10.0	25.4

<u>NET WEIGHT</u>	<u>Pounds</u>	<u>Kilograms</u>
	47	21.3

<u>SERVICE CLEARANCES</u>	<u>Inches</u>	<u>Centimeters</u>
FRONT	20	50.8
REAR	0	0
LEFT	0	0
RIGHT	0	0
TOP	18	45.7

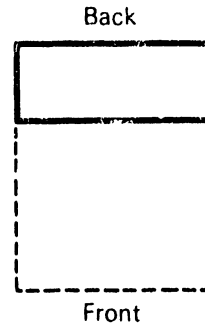

<u>POWER REQUIREMENTS</u>	<u>115V/60Hz</u>	<u>230V/50Hz</u>
AMPS	3.0 (SB)	1.5 (SB)
WATTS		230
DEDICATED CIRCUIT		YES

<u>HEAT OUTPUT (MAX)</u>	<u>Btu/hr</u>	<u>Kcal/hr</u>
	745	187.8

<u>CABLE LENGTH (MAX)</u>	<u>Feet</u>	<u>Meters</u>
POWER	8	2.4
DATA	-	-

NOTES

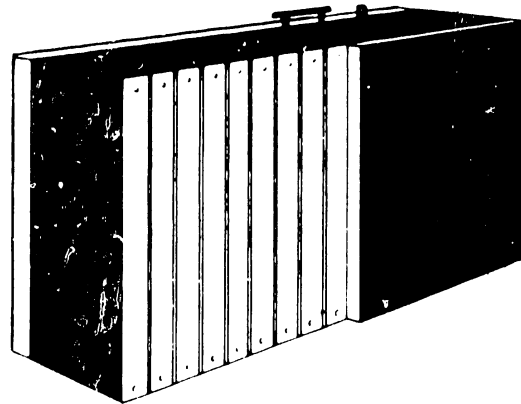

MVP CENTRAL PROCESSOR

2200MVP



PRODUCT INFORMATION SHEET

<u>DIMENSIONS</u>	<u>Inches</u>	<u>Centimeters</u>
WIDTH	25.0	63.5
HEIGHT	14.5	36.8
DEPTH	10.0	25.4

<u>NET WEIGHT</u>	<u>Pounds</u>	<u>Kilograms</u>
	47	21.1

<u>SERVICE CLEARANCES</u>	<u>Inches</u>	<u>Centimeters</u>
FRONT	20	50.8
REAR	0	0
LEFT	0	0
RIGHT	0	0
TOP	18	45.7

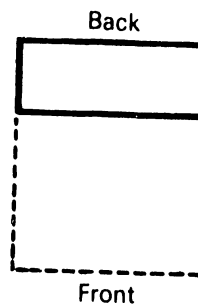

<u>POWER REQUIREMENTS</u>	<u>115V/60Hz</u>	<u>230V/50Hz</u>
AMPS	3.0 (SB)	1.5 (SB)
WATTS	230	
DEDICATED CIRCUIT	YES	

<u>HEAT OUTPUT (MAX)</u>	<u>Btu/hr</u>	<u>Kcal/hr</u>
	900	226.8

<u>CABLE LENGTH (MAX)</u>	<u>Feet</u>	<u>Meters</u>
POWER	8	2.4
DATA	-	-

NOTES

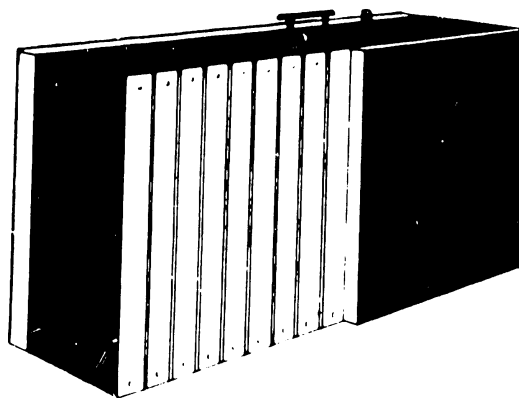

VP CENTRAL PROCESSOR

2200VP

PRODUCT INFORMATION SHEET

<u>DIMENSIONS</u>	<u>Inches</u>	<u>Centimeters</u>
WIDTH	7.5	19.1
HEIGHT	6.5	16.5
DEPTH	13.5	39.3

<u>NET WEIGHT</u>	<u>Pounds</u>	<u>Kilograms</u>
	13	5.9

<u>SERVICE CLEARANCES</u>	<u>Inches</u>	<u>Centimeters</u>
FRONT	30	76.2
REAR	30	76.2
LEFT	12	30.5
RIGHT	12	30.5
TOP	6	15.0

<u>POWER REQUIREMENTS</u>	<u>115V/60Hz</u>	<u>230V/50Hz</u>
AMPS	1.5 (SB)	1.0 (SB)
WATTS		45
DEDICATED CIRCUIT		NO

<u>HEAT OUTPUT (MAX)</u>	<u>Btu/hr</u>	<u>Kcal/hr</u>
	154	38.8

<u>CABLE LENGTH (MAX)</u>	<u>Feet</u>	<u>Meters</u>
POWER	6	1.8
DATA	8	2.4

NOTES

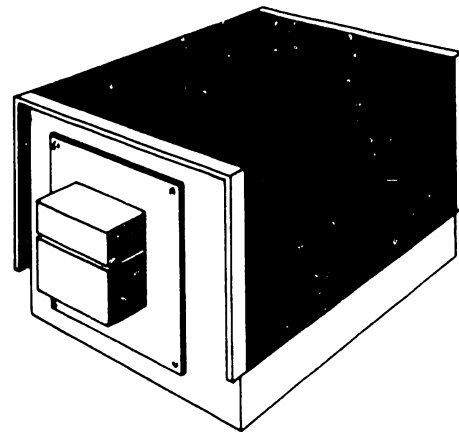
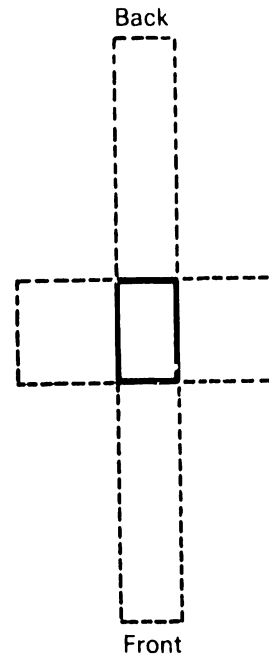

PUNCHED PAPER TAPE READER

2203

**PRODUCT INFORMATION SHEET**

<u>DIMENSIONS</u>	<u>Inches</u>	<u>Centimeters</u>
WIDTH	21.0	53.3
HEIGHT	28.0	71.1
DEPTH	28.5	72.4

<u>NET WEIGHT</u>	<u>Pounds</u>	<u>Kilograms</u>
	162	72.9

<u>SERVICE CLEARANCES</u>	<u>Inches</u>	<u>Centimeters</u>
FRONT	30	76.2
REAR	30	76.2
LEFT	30	76.2
RIGHT	30	76.2
TOP	60	152.4

<u>POWER REQUIREMENTS</u>	<u>115V/60Hz</u>	<u>230V/50Hz</u>
AMPS	2.05	1.0
WATTS		246
DEDICATED CIRCUIT		NO

<u>HEAT OUTPUT (MAX)</u>	<u>Btu/hr</u>	<u>Kcal/hr</u>
	839	211.4

<u>CABLE LENGTH (MAX)</u>	<u>Feet</u>	<u>Meters</u>
POWER	8	2.4
DATA	12	3.7

NOTES

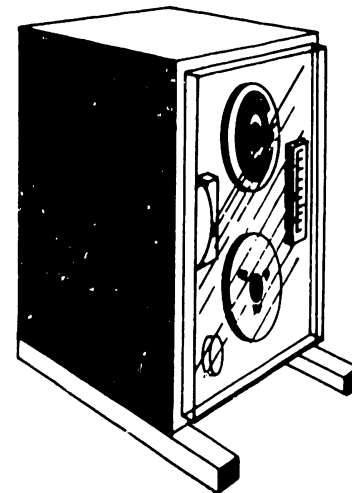

TAPE DRIVE

2209

PRODUCT INFORMATION SHEET

<u>DIMENSIONS</u>	<u>inches</u>	<u>Centimeters</u>
WIDTH	24.0	61.0
HEIGHT	34.5	87.6
DEPTH	26.0	66.0

<u>NET WEIGHT</u>	<u>Pounds</u>	<u>Kilograms</u>
	170	76.5

<u>SERVICE CLEARANCES</u>	<u>Inches</u>	<u>Centimeters</u>
FRONT	36	91.4
REAR	30	76.2
LEFT	30	76.2
RIGHT	30	76.2
TOP	60	152.4

<u>POWER REQUIREMENTS</u>	<u>115V/60Hz</u>	<u>230V/50Hz</u>
AMPS		NOTE
WATTS		475
DEDICATED CIRCUIT		NO

<u>HEAT OUTPUT (MAX)</u>	<u>Btu/hr</u>	<u>Kcal/hr</u>
	1,623	409

<u>CABLE LENGTH (MAX)</u>	<u>Feet</u>	<u>Meters</u>
POWER	8	2.4
DATA	12	3.7

NOTES

15A @ 115 VAC; 8A @ 230 VAC  
 3A @ 115 VAC; 1.5A @ 230 VAC  
 8A @ 115 VAC; 4A @ 230 VAC

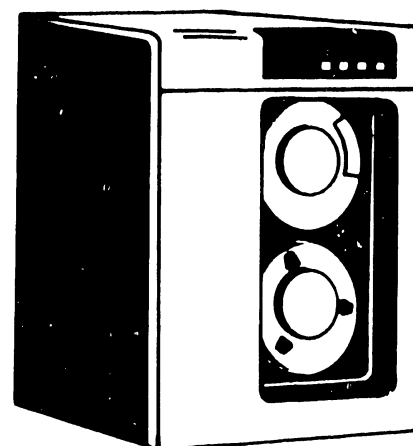
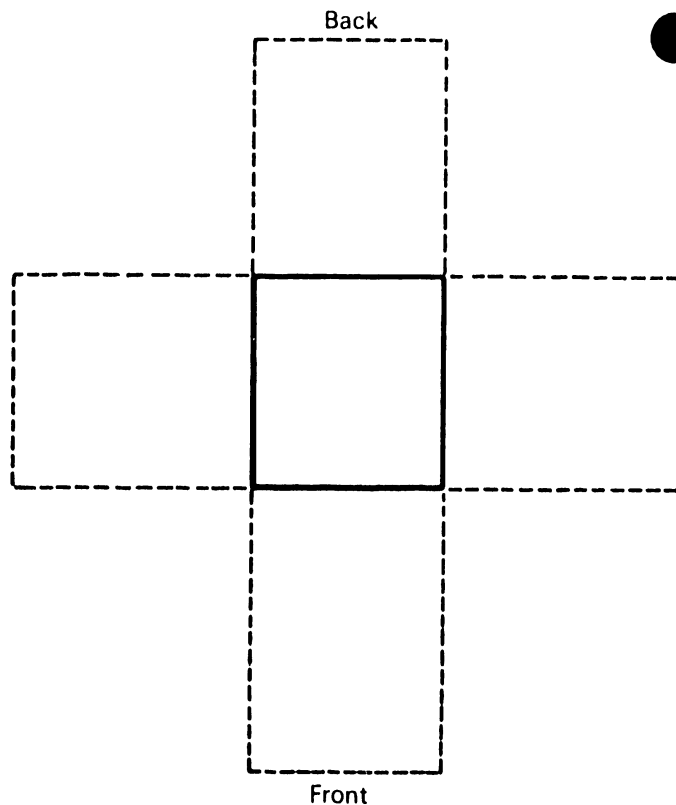

TAPE DRIVE

2209A

PRODUCT INFORMATION SHEET

<u>DIMENSIONS</u>	<u>Inches</u>	<u>Centimeters</u>
WIDTH	24.0	61.0
HEIGHT	34.5	87.6
DEPTH	26.0	66.0

<u>NET WEIGHT</u>	<u>Pounds</u>	<u>Kilograms</u>
	170	76.5

<u>SERVICE CLEARANCES</u>	<u>Inches</u>	<u>Centimeters</u>
FRONT	36	91.4
REAR	30	76.2
LEFT	30	76.2
RIGHT	30	76.2
TOP	60	152.4

<u>POWER REQUIREMENTS</u>	<u>115V/60Hz</u>	<u>230V/50Hz</u>
---------------------------	------------------	------------------

AMPS	NOTE
WATTS	472
DEDICATED	
CIRCUIT	NO

<u>HEAT OUTPUT (MAX)</u>	<u>Btu/hr</u>	<u>Kcal/hr</u>
	1,623	409

<u>CABLE LENGTH (MAX)</u>	<u>Feet</u>	<u>Meters</u>
POWER	8	2.4
DATA	12	3.7

NOTES

15A @ 115 VAC; 8A @ 230 VAC  
 3A @ 115 VAC; 1.5 @ 230 VAC  
 8A @ 115 VAC; 4A @ 230 VAC

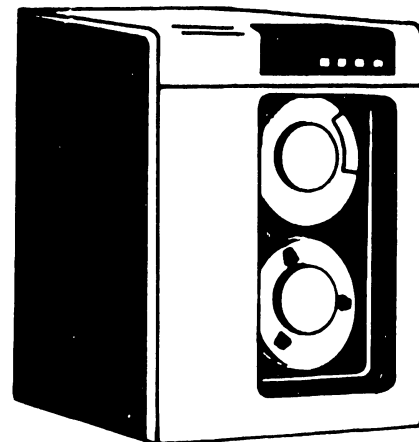
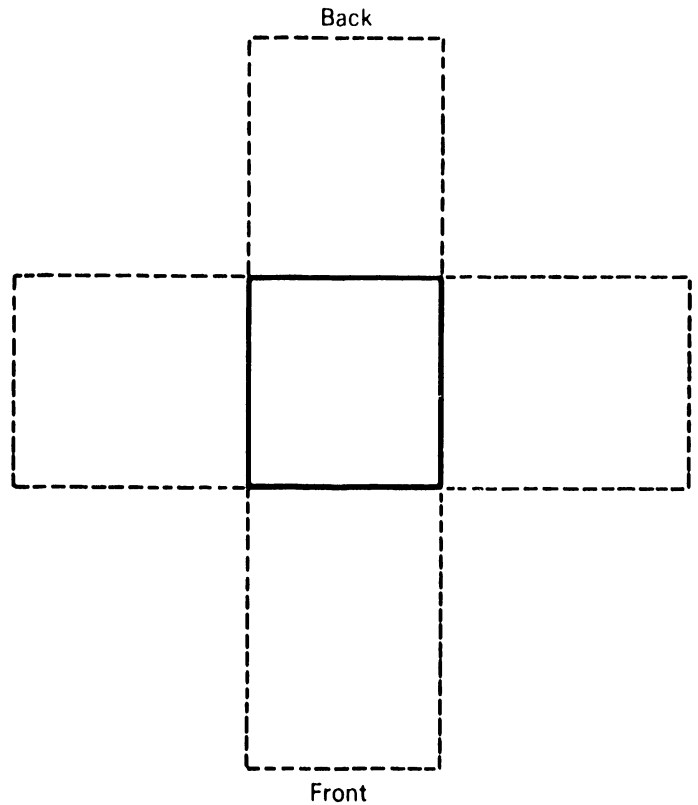

TAPE DRIVE

2209V

**PRODUCT INFORMATION SHEET**

<u>DIMENSIONS</u>	<u>Inches</u>	<u>Centimeters</u>
WIDTH	19.75	50.2
HEIGHT	18.75	47.6
DEPTH	20.5	52.1

<u>NET WEIGHT</u>	<u>Pounds</u>	<u>Kilograms</u>
	51	22.9

<u>SERVICE CLEARANCES</u>	<u>Inches</u>	<u>Centimeters</u>
FRONT	36	90.0
REAR	0	0
LEFT	12	30.5
RIGHT	12	30.5
TOP	24	61.0

<u>POWER REQUIREMENTS</u>	<u>115V/60Hz</u>	<u>230V/50Hz</u>
AMPS	2.0	1.0
WATTS		158
DEDICATED CIRCUIT		NO

<u>HEAT OUTPUT (MAX)</u>	<u>Btu/hr</u>	<u>Kcal/hr</u>
	540	136

<u>CABLE LENGTH (MAX)</u>	<u>Feet</u>	<u>Meters</u>
POWER	8	2.4
DATA	NOTE	NOTE

NOTES

Three 8 ft (2.4 m) to controller

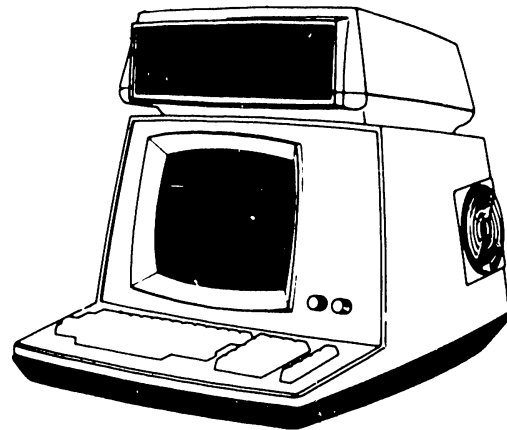
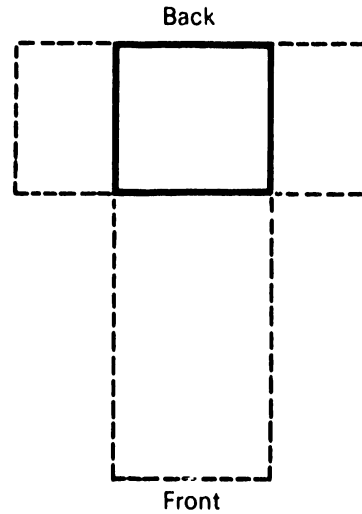

CRT/MINI-DISKETTE CONSOLE

2210

PRODUCT INFORMATION SHEET

<u>DIMENSIONS</u>	<u>Inches</u>	<u>Centimeters</u>
WIDTH	8.0	20.3
HEIGHT	5.5	14.0
DEPTH	11.5	29.2

<u>NET WEIGHT</u>	<u>Pounds</u>	<u>Kilograms</u>
	15	6.7

<u>SERVICE CLEARANCES</u>	<u>Inches</u>	<u>Centimeters</u>
FRONT	15	38.1
REAR	15	38.1
LEFT	15	38.1
RIGHT	15	38.1
TOP	6	15.0

<u>POWER REQUIREMENTS</u>	<u>115V/60Hz</u>	<u>230V/50Hz</u>
AMPS	.3	.15
WATTS		25
DEDICATED CIRCUIT		NO

<u>HEAT OUTPUT (MAX)</u>	<u>Btu/hr</u>	<u>Kcal/hr</u>
	85	21.4

<u>CABLE LENGTH (MAX)</u>	<u>Feet</u>	<u>Meters</u>
POWER DATA	6 NOTE	1.8

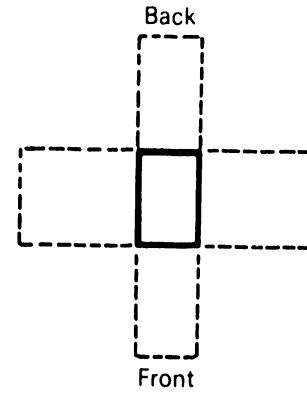

NOTES

Four 12-ft (3.66 m) connector cables

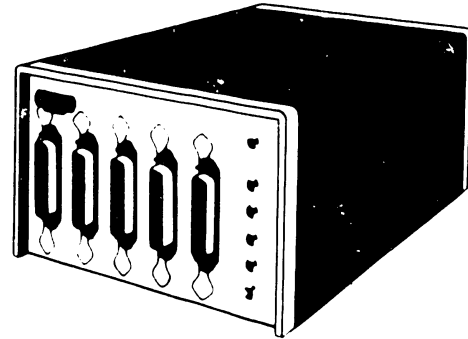

PRINTER MULTIPLEXER

2211M

PRODUCT INFORMATION SHEET

<u>DIMENSIONS</u>	<u>Inches</u>	<u>Centimeters</u>
WIDTH	29	73.7
HEIGHT	12	30.5
DEPTH	25	63.5

<u>NET WEIGHT</u>	<u>Pounds</u>	<u>Kilograms</u>
	85	38.2

<u>SERVICE CLEARANCES</u>	<u>Inches</u>	<u>Centimeters</u>
FRONT	30	76.2
REAR	36	91.4
LEFT	24	61.0
RIGHT	24	61.0
TOP	0	0

<u>POWER REQUIREMENTS</u>	<u>115V/60Hz</u>	<u>230V/50Hz</u>
AMPS	4.0 (SB)	2.0 (SB)
WATTS	300	
DEDICATED CIRCUIT		NO

<u>HEAT OUTPUT (MAX)</u>	<u>Btu/hr</u>	<u>Kcal/hr</u>
	1,200	302

<u>CABLE LENGTH (MAX)</u>	<u>Feet</u>	<u>Meters</u>
POWER	6	1.8
DATA	NOTE	NOTE

NOTES

2221W Data 12 ft (3.7 m)  
 2221V Data 50 ft (15.25 m)

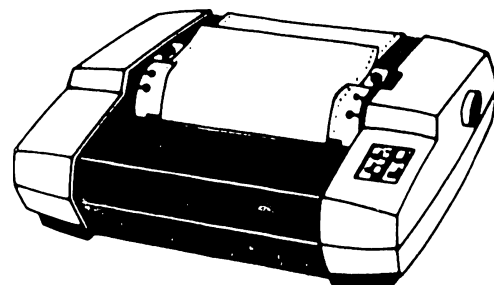
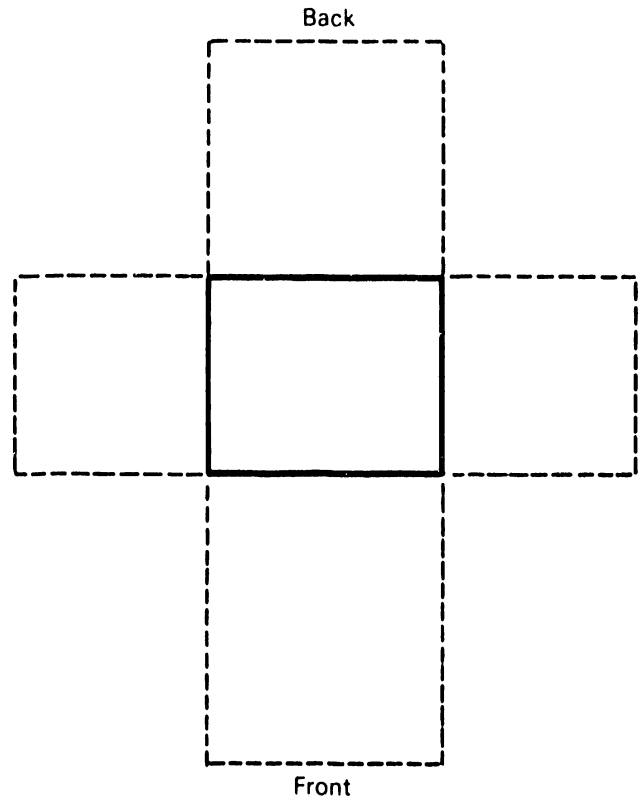

MATRIX PRINTER

2221W, 2221V



**PRODUCT INFORMATION SHEET**

<u>DIMENSIONS</u>	<u>Inches</u>	<u>Centimeters</u>
WIDTH	19.75	50.2
HEIGHT	13.5	34.3
DEPTH	20.5	52.1

<u>NET WEIGHT</u>	<u>Pounds</u>	<u>Kilograms</u>
	50	22.5

<u>SERVICE CLEARANCES</u>	<u>Inches</u>	<u>Centimeters</u>
FRONT	36	91.4
REAR	0	0
LEFT	12	30.5
RIGHT	12	30.5
TOP	18	45.7

<u>POWER REQUIREMENTS</u>	<u>115V/60Hz</u>	<u>230V/50Hz</u>
AMPS	1.5 (SB)	1.0 (SB)
WATTS		65
DEDICATED CIRCUIT		NO

<u>HEAT OUTPUT (MAX)</u>	<u>Btu/hr</u>	<u>Kcal/hr</u>
	222	55.9

<u>CABLE LENGTH (MAX)</u>	<u>Feet</u>	<u>Meters</u>
POWER	8	2.4
DATA	NOTE	NOTE

NOTES

Two 8 ft (2.4 m) to controller)

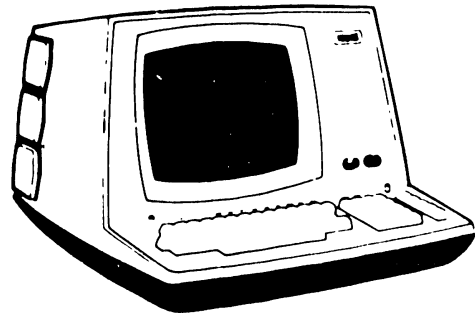
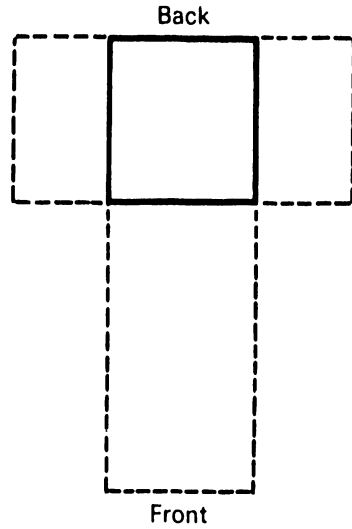

CRT/KEYBOARD CONSOLE

2226

**PRODUCT INFORMATION SHEET**

<u>DIMENSIONS</u>	<u>Inches</u>	<u>Centimeters</u>
WIDTH	24	61.0
HEIGHT	10	25.4
DEPTH	18	45.7

<u>NET WEIGHT</u>	<u>Pounds</u>	<u>Kilograms</u>
-------------------	---------------	------------------

NOTE 1

<u>SERVICE CLEARANCES</u>	<u>Inches</u>	<u>Centimeters</u>
FRONT	30	76.2
REAR	30	76.2
LEFT	24	61.0
RIGHT	24	61.0
TOP	0	0

<u>POWER REQUIREMENTS</u>	<u>115V/60Hz</u>	<u>230V/50Hz</u>
AMPS	1.5 (SB)	.8 (SB)
WATTS		150
DEDICATED CIRCUIT		NO

<u>HEAT OUTPUT (MAX)</u>	<u>Btu/hr</u>	<u>Kcal/hr</u>
	600	151.2

<u>CABLE LENGTH (MAX)</u>	<u>Feet</u>	<u>Meters</u>
POWER	6	1.8
DATA	NOTE 2	NOTE 2

NOTES

1. 2231V-1, -2 68 lb (30.6 kg)  
 2231W-1, -2 60 lb (27.0 kg)  
 2231W-3 82 lb (36.9 kg)  
 2231W-6 70 lb (31.4 kg)
  
2. 2231V-1 50 ft (15.3 m)  
 2231V-2 50 ft (15.3 m)  
 2231W-1 12 ft (3.66 m)  
 2231W-2 12 ft (3.66 m)  
 2231W-3 12 ft (3.66 m)  
 2231W-6 12 ft (3.66 m)

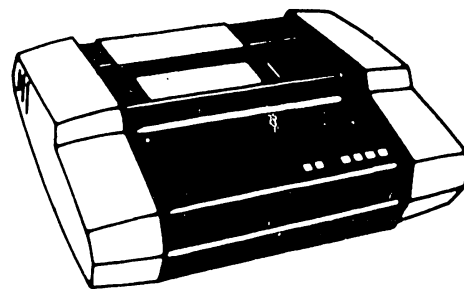
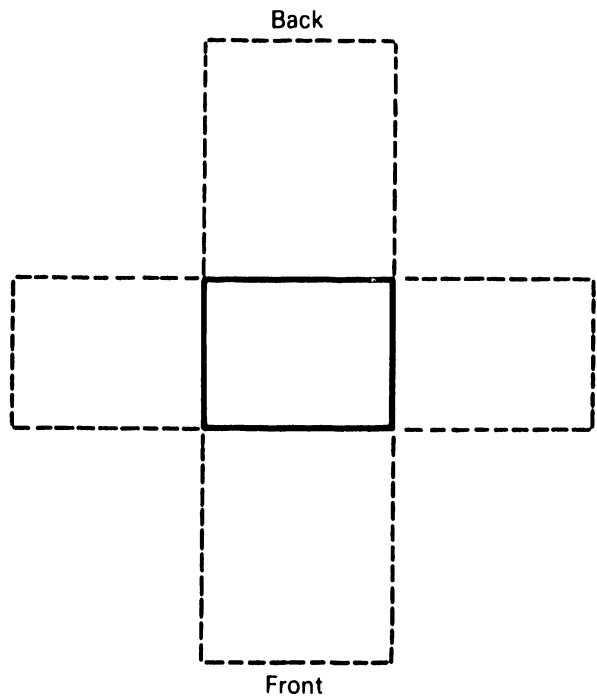

MATRIX PRINTER

2231

PRODUCT INFORMATION SHEET

<u>DIMENSIONS*</u>	<u>Inches</u>	<u>Centimeters</u>
WIDTH (Table)	60.25	153.0
HEIGHT (Table)	9.5	24.1
DEPTH (Table)	46.0	116.8

<u>NET WEIGHT</u>	<u>Pounds</u>	<u>Kilograms</u>
	112	50.1

<u>SERVICE CLEARANCES</u>	<u>Inches</u>	<u>Centimeters</u>
FRONT	-	-
REAR	12	30.5
LEFT	-	-
RIGHT	-	-
TOP	-	-

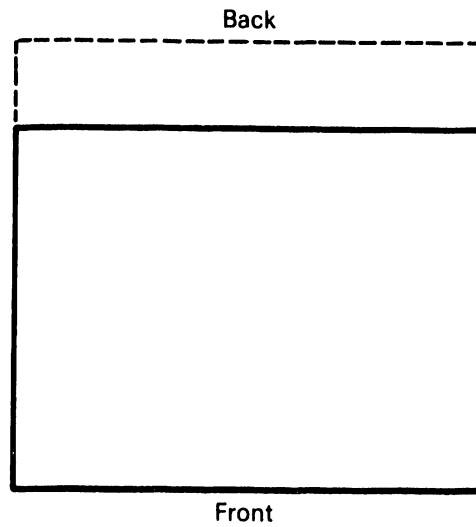

<u>POWER REQUIREMENTS</u>	<u>115V/60Hz</u>	<u>230V/50Hz</u>
AMPS	2.0	2.0
WATTS		175
DEDICATED CIRCUIT		NO

<u>HEAT OUTPUT (MAX)</u>	<u>Btu/hr</u>	<u>Kcal/hr</u>
	595	150

<u>CABLE LENGTH (MAX)</u>	<u>Feet</u>	<u>Meters</u>
POWER	8	2.4
DATA	NOTE	

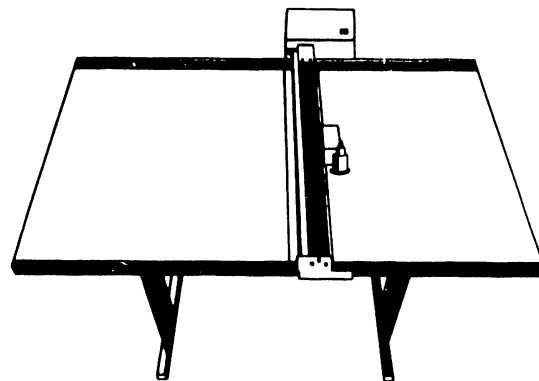

NOTES

\*WIDTH (Control Unit) 18 in. (45.7 cm)  
 HEIGHT (Control Unit) 19 in. (48.3 cm)  
 DEPTH (Control Unit) 10 in. (25.4 cm)  
 WEIGHT (Control Unit) 30 lb (13.6 kg)

10 ft (3 m) from control unit to CPU  
 10 ft (3 m) from control unit to plotter arm

DIGITAL FLATBED PLOTTER

2232B

**PRODUCT INFORMATION SHEET**

<u>DIMENSIONS</u>	<u>Inches</u>	<u>Centimeters</u>
WIDTH	19.75	50.2
HEIGHT	13.5	34.3
DEPTH	20.5	52.1

<u>NET WEIGHT</u>	<u>Pounds</u>	<u>Kilograms</u>
	51	22.9

<u>SERVICE CLEARANCES</u>	<u>Inches</u>	<u>Centimeters</u>
FRONT	36	91.4
REAR	0	0
LEFT	12	30.5
RIGHT	12	30.5
TOP	18	45.7

<u>POWER REQUIREMENTS</u>	<u>115V/60Hz</u>	<u>230V/50Hz</u>
AMPS	2.0	1.0
WATTS		40
DEDICATED CIRCUIT		NO

<u>HEAT OUTPUT (MAX)</u>	<u>Btu/hr</u>	<u>Kcal/hr</u>
	348	87.7

<u>CABLE LENGTH (MAX)</u>	<u>Feet</u>	<u>Meters</u>
POWER	8	2.4
DATA	NOTE	NOTE

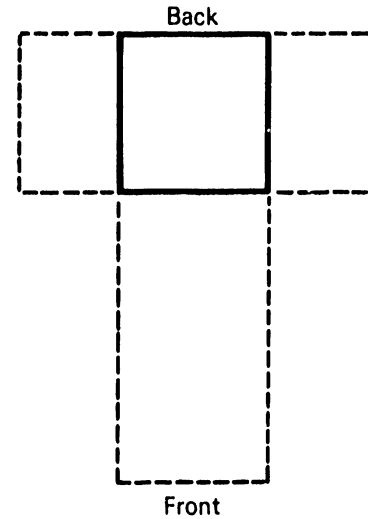

**NOTES**

1000 ft (304.8 m) direct  
connection to CPU  
50 ft (15.2 m) to Modem

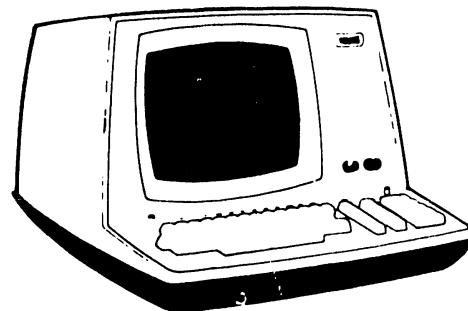

**INTERACTIVE TERMINAL**

2236DE

**PRODUCT INFORMATION SHEET**

<u>DIMENSIONS</u>	<u>Inches</u>	<u>Centimeters</u>
WIDTH	19	48.3
HEIGHT	11	27.9
DEPTH	14	35.6

<u>NET WEIGHT</u>	<u>Pounds</u>	<u>Kilograms</u>
	60	27.0

<u>SERVICE CLEARANCES</u>	<u>Inches</u>	<u>Centimeters</u>
FRONT	30	76.2
REAR	24	61.0
LEFT	0	0
RIGHT	0	0
TOP	0	0

<u>POWER REQUIREMENTS</u>	<u>115V/60Hz</u>	<u>230V/50Hz</u>
---------------------------	------------------	------------------

AMPS	NOTE
WATTS	NOTE
DEDICATED CIRCUIT	NO

<u>HEAT OUTPUT (MAX)</u>	<u>Btu/hr</u>	<u>Kcal/hr</u>
	1,938	488.4

<u>CABLE LENGTH (MAX)</u>	<u>Feet</u>	<u>Meters</u>
POWER	8	2.4
DATA	12	3.6



NOTES

14.3A @ 115V (7.15A @ 230V) Start-up  
 4.9A @ 115V (2.45A @ 230V) Running  
 1650 W Start-up  
 570 W Running

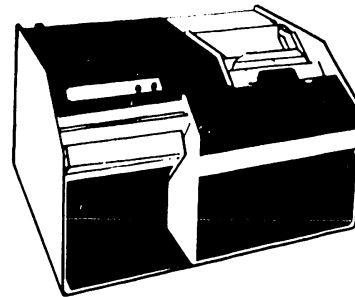

CARD READER

2244

**PRODUCT INFORMATION SHEET**

<u>DIMENSIONS</u>	<u>Inches</u>	<u>Centimeters</u>
WIDTH	19.75	50.2
HEIGHT	13.5	34.3
DEPTH	20.5	52.0

<u>NET WEIGHT</u>	<u>Pounds</u>	<u>Kilograms</u>
	40	18.0

<u>SERVICE CLEARANCES</u>	<u>Inches</u>	<u>Centimeters</u>
FRONT	36	91.4
REAR	0	0
LEFT	12	30.5
RIGHT	12	30.5
TOP	16	40.6

<u>POWER REQUIREMENTS</u>	<u>115V/60Hz</u>	<u>230V/50Hz</u>
AMPS	2	1
WATTS		117
DEDICATED CIRCUIT		NO

<u>HEAT OUTPUT (MAX)</u>	<u>Btu/hr</u>	<u>Kcal/hr</u>
	427	107.6

<u>CABLE LENGTH (MAX)</u>	<u>Feet</u>	<u>Meters</u>
POWER	7	2.1
DATA	NOTE	NOTE

NOTES

- 2246C 2000 ft (609.6 m)
- 2246P 500 ft (152.5 m)
- 2246R 2000 ft (609.6 m)
- 2246S 2000 ft (609.6 m)

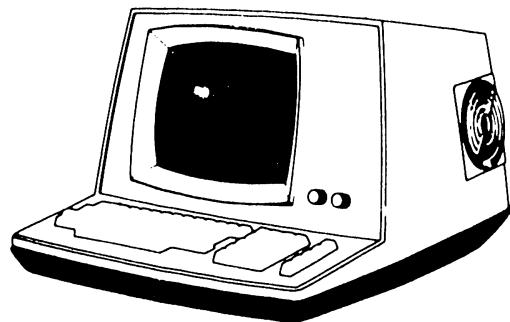
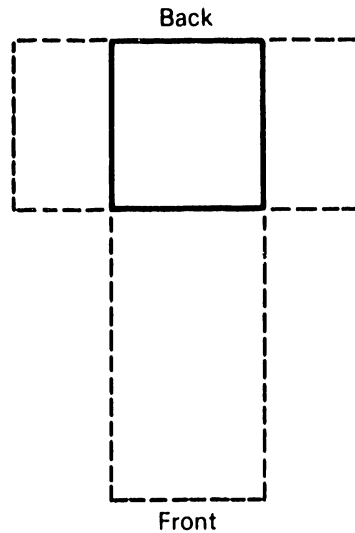

CRT/WORKSTATION

2246

PRODUCT INFORMATION SHEET

DIMENSIONS                      Inches                      Centimeters

WIDTH	8.0	20.3
HEIGHT	6.0	15.2
DEPTH	12.0	30.5

NET WEIGHT                      Pounds                      Kilograms

8.5	3.5
-----	-----

SERVICE CLEARANCES      Inches                      Centimeters

FRONT	12	30.5
REAR	12	30.5
LEFT	0	0
RIGHT	0	0
TOP	6	15.2

POWER REQUIREMENTS      115V/60Hz                  230V/50Hz

AMPS	2.0	1.0
WATTS		65
DEDICATED		
CIRCUIT		NO

HEAT OUTPUT (MAX)              Btu/hr                      Kcal/hr

200	50.0
-----	------

CABLE LENGTH (MAX)              Feet                      Meters

POWER	6	1.8
DATA	50	15.2

NOTES

Back

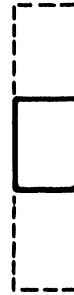

Front

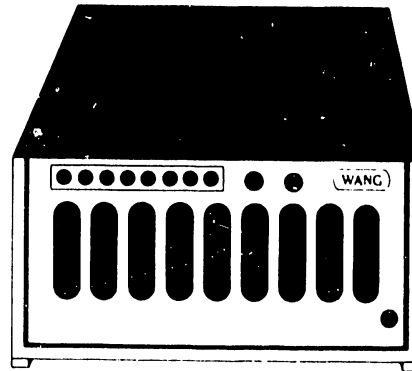

MODEM SHARING UNIT

2247V-4

PRODUCT INFORMATION SHEET

<u>DIMENSIONS</u>	<u>Inches</u>	<u>Centimeters</u>
WIDTH	18.95	48.1
HEIGHT	28	71.1
DEPTH	30.7	78.0

<u>NET WEIGHT</u>	<u>Pounds</u>	<u>Kilograms</u>
	130	58.5

<u>SERVICE CLEARANCES</u>	<u>Inches</u>	<u>Centimeters</u>
FRONT	36	91.4
REAR	30	76.2
LEFT	24	61.0
RIGHT	12	30.5
TOP	38	96.5

<u>POWER REQUIREMENTS</u>	<u>115V/60Hz</u>	<u>230V/50Hz</u>
AMPS	7.0	3.5
WATTS		500
DEDICATED CIRCUIT		YES

<u>HEAT OUTPUT (MAX)</u>	<u>Btu/hr</u>	<u>Kcal/hr</u>
	1,050	264.6

<u>CABLE LENGTH (MAX)</u>	<u>Feet</u>	<u>Meters</u>
POWER	8	2.5
DATA	NOTE	

NOTES

10 ft (3.04 m) to CPU or  
5 ft (1.52 m) to previous drive

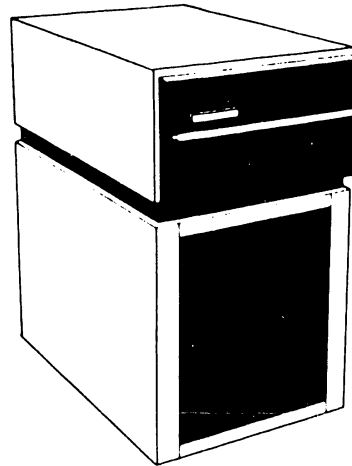
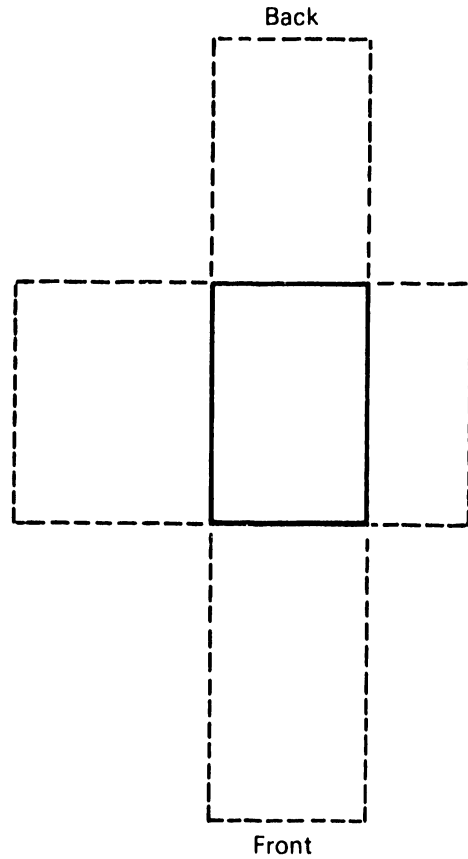

5/10 MB F/R DISK DRIVE

2260



**PRODUCT INFORMATION SHEET**

<u>DIMENSIONS</u>	<u>Inches</u>	<u>Centimeters</u>
WIDTH	27.0	68.6
HEIGHT	36.0	91.4
DEPTH	26.0	66.0

<u>NET WEIGHT</u>	<u>Pounds</u>	<u>Kilograms</u>
	210	94.5

<u>SERVICE CLEARANCES</u>	<u>Inches</u>	<u>Centimeters</u>
FRONT	30	76.2
REAR	30	76.2
LEFT	24	61.0
RIGHT	0	0
TOP	0	0

<u>POWER REQUIREMENTS</u>	<u>115V/60Hz</u>	<u>230V/50Hz</u>
AMPS	5.0 (SB)	2.5 (SB)
WATTS		840
DEDICATED CIRCUIT		NO

<u>HEAT OUTPUT (MAX)</u>	<u>Btu/hr</u>	<u>Kcal/hr</u>
	2,864	721.8

<u>CABLE LENGTH (MAX)</u>	<u>Feet</u>	<u>Meters</u>
POWER	6	1.8
DATA	12	3.7

NOTES

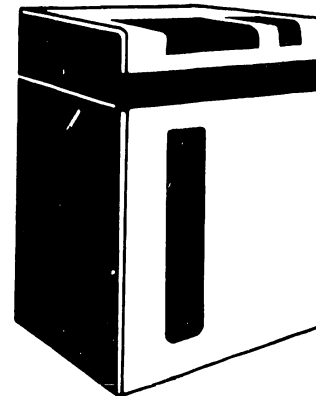
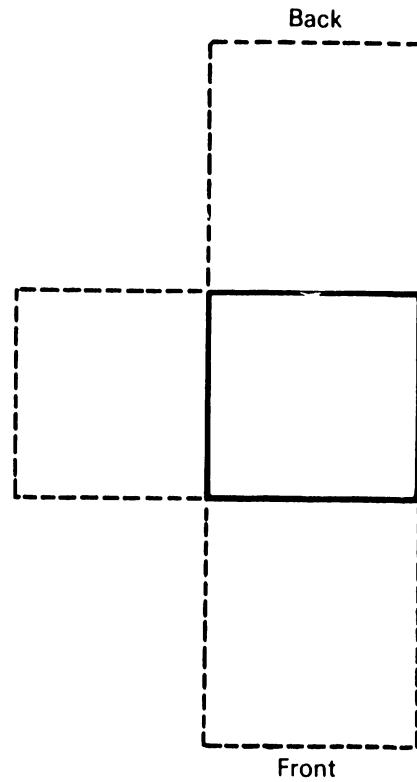

QUAD HEAD MATRIX PRINTER

2261W

**PRODUCT INFORMATION SHEET**

<u>DIMENSIONS</u>	<u>Inches</u>	<u>Centimeters</u>
WIDTH	36.5	92.7
HEIGHT	42.0	106.7
DEPTH	32.0	81.3

<u>NET WEIGHT</u>	<u>Pounds</u>	<u>Kilograms</u>
	570	256.5

<u>SERVICE CLEARANCES</u>	<u>Inches</u>	<u>Centimeters</u>
FRONT	36	91.4
REAR	30	76.2
LEFT	24	61.0
RIGHT	24	61.0
TOP	61	154.9

<u>POWER REQUIREMENTS</u>	<u>115V/60Hz</u>	<u>230V/50Hz</u>
AMPS	5.5	3.0
WATTS		690
DEDICATED CIRCUIT		NO

<u>HEAT OUTPUT (MAX)</u>	<u>Btu/hr</u>	<u>Kcal/hr</u>
	2,700	680.4

<u>CABLE LENGTH (MAX)</u>	<u>Feet</u>	<u>Meters</u>
POWER	12	3.66
DATA	50	15.2

NOTES

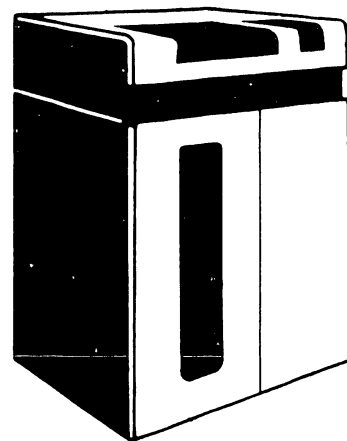
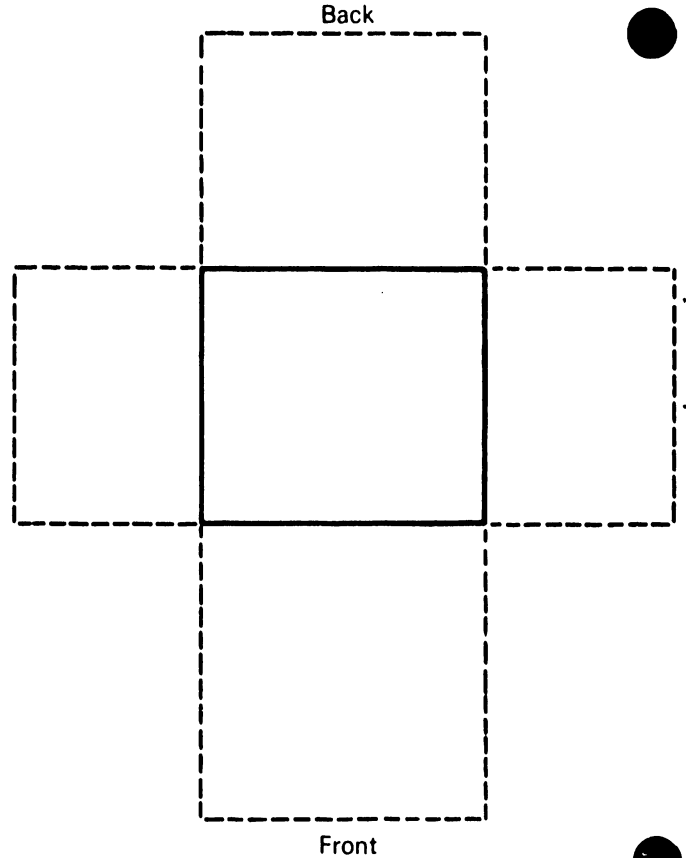

CHAIN PRINTER

2263-1, 2263-2, 2263-3

**PRODUCT INFORMATION SHEET**

<u>DIMENSIONS</u>	<u>Inches</u>	<u>Centimeters</u>
WIDTH	24.0	61.0
HEIGHT	41.0	104.1
DEPTH	36.0	91.4

<u>NET WEIGHT</u>	<u>Pounds</u>	<u>Kilograms</u>
	500	225

<u>SERVICE CLEARANCES</u>	<u>Inches</u>	<u>Centimeters</u>
FRONT	36	91.4
REAR	30	76.2
LEFT	18	45.7
RIGHT	18	45.7
TOP	47	119.4

<u>POWER REQUIREMENTS</u>	<u>115V/60Hz</u>	<u>230V/50Hz</u>
AMPS	NOTE 1	NOTE 1
WATTS		943
DEDICATED CIRCUIT		YES

<u>HEAT OUTPUT (MAX)</u>	<u>Btu/hr</u>	<u>Kcal/hr</u>
	2,580	650.2

<u>CABLE LENGTH (MAX)</u>	<u>Feet</u>	<u>Meters</u>
POWER	6	1.8
DATA	NOTE 2	NOTE 2

**NOTES**

1. 20A @ 115V (10A @ 230V) Start up  
 8.2A @ 115V (4.1A @ 230V) Running  
 1.5A @ 115V (.75A @ 230V) Standby
2. 15 ft (4.6 m) to CPU  
 10 ft (3.1 m) to previous 2265V-1  
 24 ft (7.3 m) to last drive

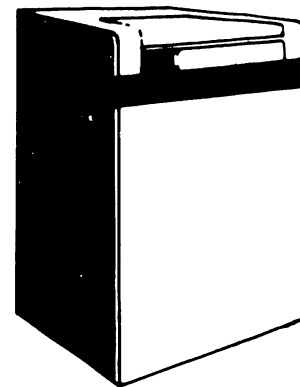
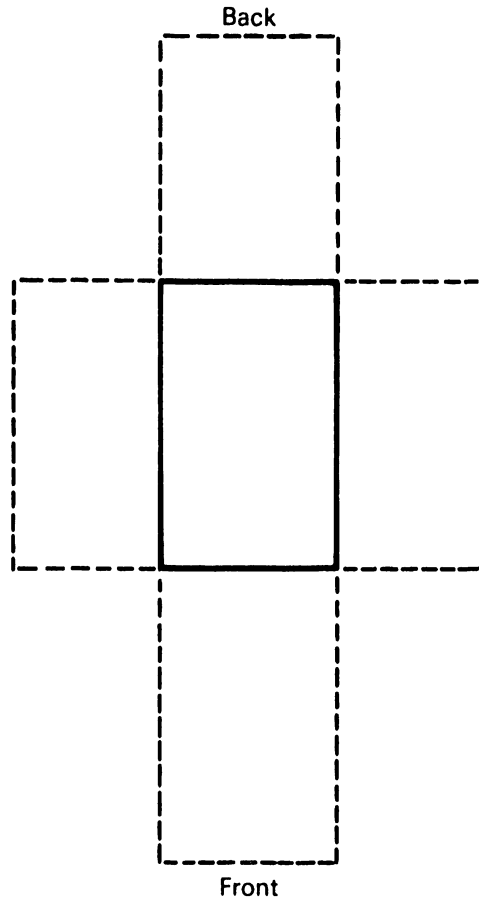

**75 MB DISK DRIVE**

2265V-1

PRODUCT INFORMATION SHEET

<u>DIMENSIONS</u>	<u>Inches</u>	<u>Centimeters</u>
WIDTH	24.0	61.0
HEIGHT	41.0	104.1
DEPTH	36.0	91.4

<u>NET WEIGHT</u>	<u>Pounds</u>	<u>Kilograms</u>
	550	247.5

<u>SERVICE CLEARANCES</u>	<u>Inches</u>	<u>Centimeters</u>
FRONT	36	91.4
REAR	30	76.2
LEFT	12	30.5
RIGHT	12	30.5
TOP	60	152.4

<u>POWER REQUIREMENTS</u>	<u>115V/60Hz</u>	<u>230V/50Hz</u>
AMPS	NOTE 1	NOTE 1
WATTS	1,200	
DEDICATED CIRCUIT	YES	

<u>HEAT OUTPUT (MAX)</u>	<u>Btu/hr</u>	<u>Kcal/hr</u>
	4,200	1,058.5

<u>CABLE LENGTH (MAX)</u>	<u>Feet</u>	<u>Meters</u>
POWER	6	1.8
DATA	NOTE 2	NOTE 2

NOTES

1.           20A @ 230V Start-up  
            4.1A @ 230V Running  
            1.0A @ 230V Standby
2. 15 ft (4.6 m) to CPU or  
    10 ft (3.04 m) to previous 2265V  
    24 ft (7.3 m) to last drive

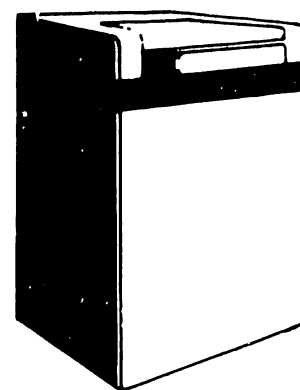
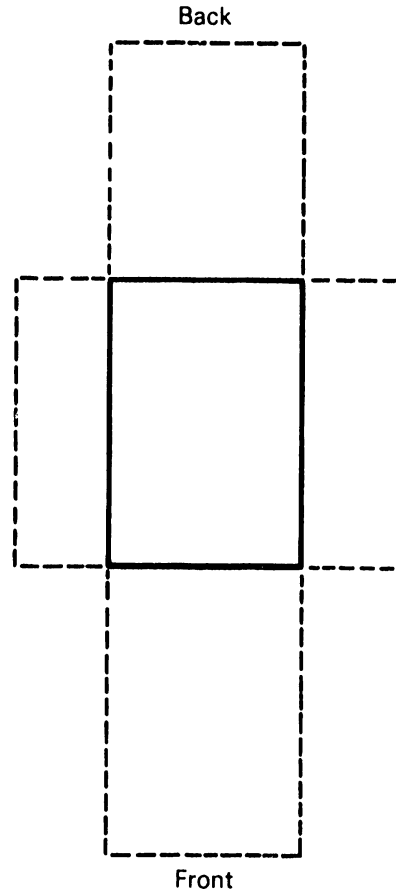

288 MB DISK DRIVE

2265V-2

PRODUCT INFORMATION SHEET

<u>DIMENSIONS</u>	<u>Inches</u>	<u>Centimeters</u>
WIDTH	16.5	42.0
HEIGHT	13.25	33.6
DEPTH	22.0	55.9

<u>NET WEIGHT</u>	<u>Pounds</u>	<u>Kilograms</u>
	57	25.6

<u>SERVICE CLEARANCES</u>	<u>Inches</u>	<u>Centimeters</u>
FRONT	30	76.2
REAR	12	30.5
LEFT	12	30.5
RIGHT	12	30.5
TOP	14	35.6

<u>POWER REQUIREMENTS</u>	<u>115V/60Hz</u>	<u>230V/50Hz</u>
AMPS	2.0	1.0
WATTS		250
DEDICATED CIRCUIT		NO

<u>HEAT OUTPUT (MAX)</u>	<u>Btu/hr</u>	<u>Kcal/hr</u>
	855	215.5

<u>CABLE LENGTH (MAX)</u>	<u>Feet</u>	<u>Meters</u>
POWER	6	1.8
DATA	25	7.6

NOTES

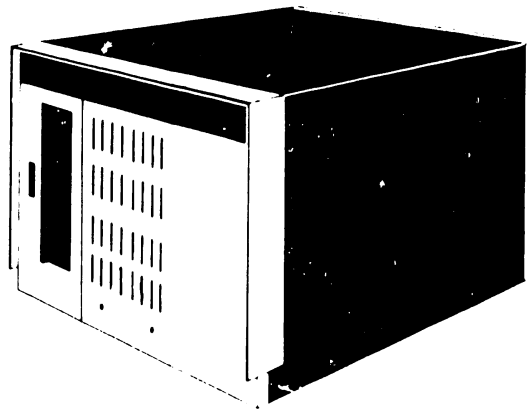
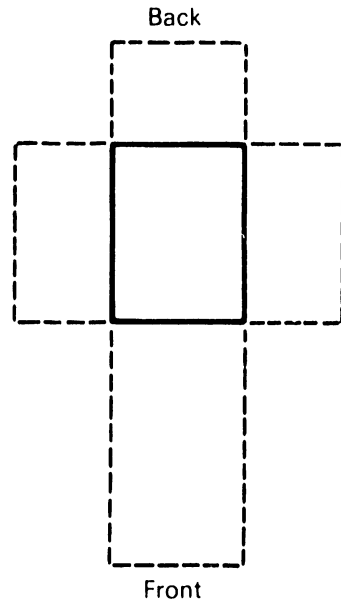

VS ARCHIVING WORKSTATION (VS-AWS) MASTER

2266S-1, -2, -3; 2266C-1, -3

**PRODUCT INFORMATION SHEET**

<u>DIMENSIONS</u>	<u>Inches</u>	<u>Centimeters</u>
WIDTH	17.5	44.5
HEIGHT	19.0	48.3
DEPTH	16.3	41.4

<u>NET WEIGHT</u>	<u>Pounds</u>	<u>Kilograms</u>
	NOTE	NOTE

<u>SERVICE CLEARANCES</u>	<u>Inches</u>	<u>Centimeters</u>
FRONT	18	45.7
REAR	0	0
LEFT	12	30.5
RIGHT	12	30.5
TOP	48	122.0

<u>POWER REQUIREMENTS</u>	<u>115V/60Hz</u>	<u>230V/50Hz</u>
AMPS	1.75	.8
WATTS		210
DEDICATED CIRCUIT		NO

<u>HEAT OUTPUT (MAX)</u>	<u>Btu/hr</u>	<u>Kcal/hr</u>
	716	180.4

<u>CABLE LENGTH (MAX)</u>	<u>Feet</u>	<u>Meters</u>
POWER	8	2.4
DATA	12	3.7

**NOTES**

- 2270-1, 2270A-1 74 1b (33.3 kg)
- 2270-2, 2270A-2 82 1b (36.9 kg)
- 2270-2, 2270A-3 94 1b (42.3 kg)

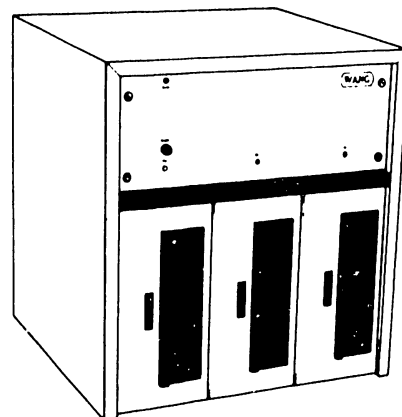
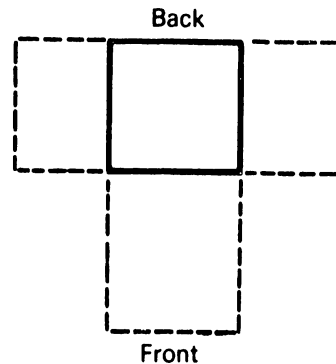

**FLOPPY DISKETTE DRIVES**

2270, 2270A

**PRODUCT INFORMATION SHEET**

<u>DIMENSIONS</u>	<u>Inches</u>	<u>Centimeters</u>
WIDTH	33.0	83.8
HEIGHT	10.2	25.9
DEPTH	14.0	35.6

<u>NET WEIGHT</u>	<u>Pounds</u>	<u>Kilograms</u>
	68	30.6

<u>SERVICE CLEARANCES</u>	<u>Inches</u>	<u>Centimeters</u>
FRONT	0	0
REAR	36	91.4
LEFT	15	38.1
RIGHT	15	38.1
TOP	0	0

<u>POWER REQUIREMENTS</u>	<u>115V/60Hz</u>	<u>230V/50Hz</u>
AMPS	3.5	1.5
WATTS		169
DEDICATED CIRCUIT		NO

<u>HEAT OUTPUT (MAX)</u>	<u>Btu/hr</u>	<u>Kcal/hr</u>
	577	145.4

<u>CABLE LENGTH (MAX)</u>	<u>Feet</u>	<u>Meters</u>
POWER	8	2.4
DATA	8	2.4

NOTES

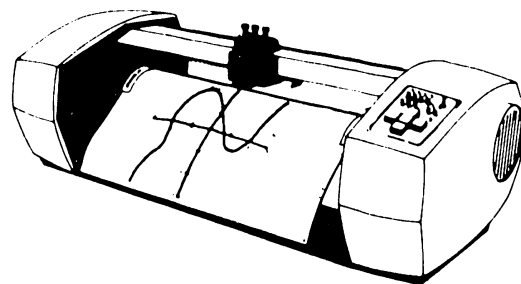
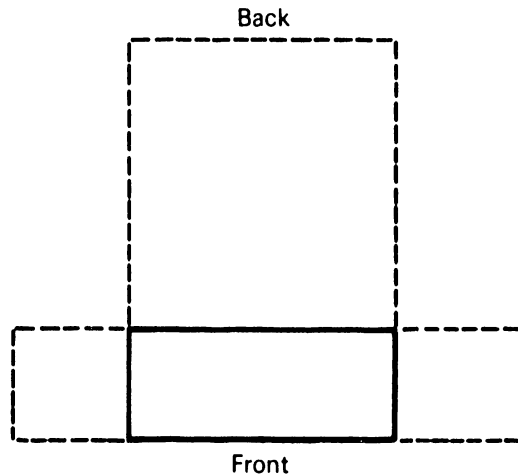

DIGITAL DRUM PLOTTER

2272-2

**PRODUCT INFORMATION SHEET**

<u>DIMENSIONS</u>	<u>Inches</u>	<u>Centimeters</u>
WIDTH	30.5	77.5
HEIGHT*	43.75	111.1
DEPTH	25.1	63.7

<u>NET WEIGHT</u>	<u>Pounds</u>	<u>Kilograms</u>
	198	89.1

<u>SERVICE CLEARANCES</u>	<u>Inches</u>	<u>Centimeters</u>
FRONT	30	76.2
REAR	30	76.2
LEFT	24	61.0
RIGHT	12	30.5
TOP	58.75	149.2

<u>POWER REQUIREMENTS</u>	<u>115V/60Hz</u>	<u>230V/50Hz</u>
AMPS	3.0	1.5
WATTS		350
DEDICATED CIRCUIT		NO

<u>HEAT OUTPUT (MAX)</u>	<u>Btu/hr</u>	<u>Kcal/hr</u>
	1,200	302.4

<u>CABLE LENGTH (MAX)</u>	<u>Feet</u>	<u>Meters</u>
POWER	6	1.8
DATA	12	3.6

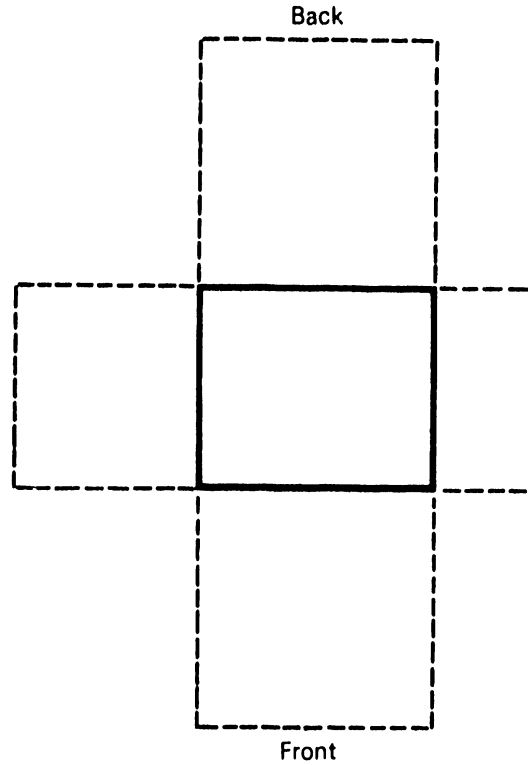

NOTES

\*Height with stand, cover closed  
 Height without stand:  
 14.5 in. (36.8 cm) cover closed  
 29.5 in. (74.9 cm) cover open

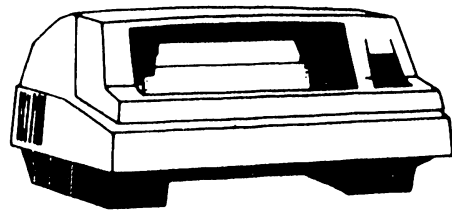

BAND PRINTER

2273-1, 2273-2, 2273V-1



PRODUCT INFORMATION SHEET

<u>DIMENSIONS*</u>	<u>Inches</u>	<u>Centimeters</u>
WIDTH	21.0	53.3
HEIGHT	13.8	35.1
DEPTH	8.5	21.6

<u>NET WEIGHT</u>	<u>Pounds</u>	<u>Kilograms</u>
	40	18

<u>SERVICE CLEARANCES</u>	<u>Inches</u>	<u>Centimeters</u>
FRONT	20	50.8
REAR	-	-
LEFT	-	-
RIGHT	-	-
TOP	-	-

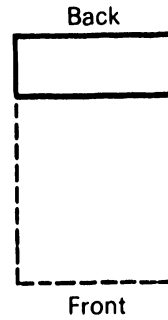

<u>POWER REQUIREMENTS</u>	<u>115V/60Hz</u>	<u>230V/50Hz</u>
AMPS	3.0 (SB)	1.5 (SB)
WATTS	150	
DEDICATED CIRCUIT	YES	

<u>HEAT OUTPUT (MAX)</u>	<u>Btu/hr</u>	<u>Kcal/hr</u>
	510	127

<u>CABLE LENGTH (MAX)</u>	<u>Feet</u>	<u>Meters</u>
POWER	8	2.5
DATA	NOTE	

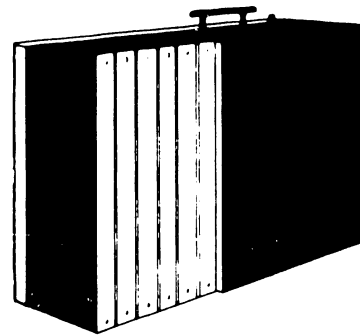

NOTES

\*DPU will be inserted in disk cabinet  
12 ft (3.6 m) cable controller to microprocessor

DISK PROCESSING UNIT FOR 2280

2280

**PRODUCT INFORMATION SHEET**

<u>DIMENSIONS</u>	<u>Inches</u>	<u>Centimeters</u>
WIDTH	25.0	63.5
HEIGHT	9.0	22.9
DEPTH	19.5	49.5

<u>NET WEIGHT</u>	<u>Pounds</u>	<u>Kilograms</u>
	70	31.5

<u>SERVICE CLEARANCES</u>	<u>Inches</u>	<u>Centimeters</u>
FRONT	30	76.2
REAR	30	76.2
LEFT	24	61.0
RIGHT	12	30.5
TOP	0	0

<u>POWER REQUIREMENTS</u>	<u>115V/60Hz</u>	<u>230V/50Hz</u>
AMPS	3.0 (SB)	1.5 (SB)
WATTS	250	
DEDICATED CIRCUIT		NO

<u>HEAT OUTPUT (MAX)</u>	<u>Btu/hr</u>	<u>Kcal/hr</u>
	1,000	252

<u>CABLE LENGTH (MAX)</u>	<u>Feet</u>	<u>Meters</u>
POWER	6	1.8
DATA	12	3.7

NOTES

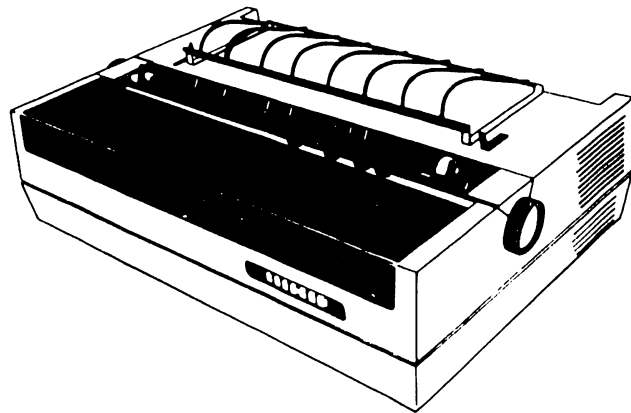
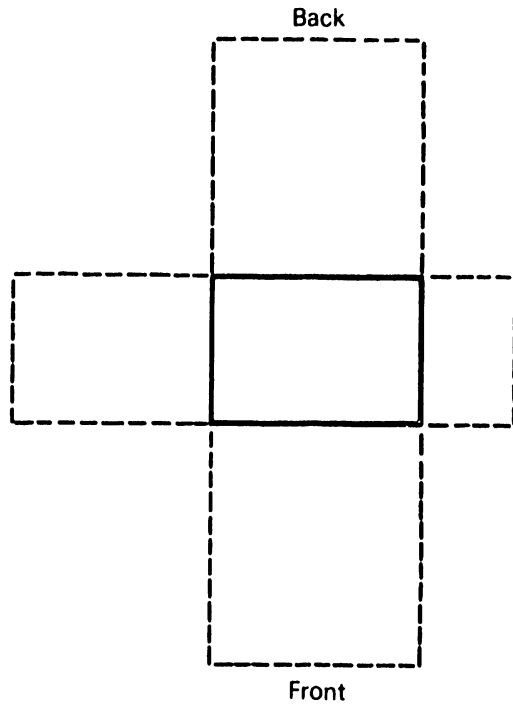

DAISY PRINTER

2281W

**PRODUCT INFORMATION SHEET**

<u>DIMENSIONS</u>	<u>Inches</u>	<u>Centimeters</u>
WIDTH	28.75	73.0
HEIGHT	9.00	22.9
DEPTH	19.50	49.5

<u>NET WEIGHT</u>	<u>Pounds</u>	<u>Kilograms</u>
	70	31.5

<u>SERVICE CLEARANCES</u>	<u>Inches</u>	<u>Centimeters</u>
FRONT	30	76.2
REAR	36	91.4
LEFT	24	61.0
RIGHT	12	30.5
TOP	0	0

<u>POWER REQUIREMENTS</u>	<u>115V/60Hz</u>	<u>230V/50Hz</u>
AMPS	3.0	1.5
WATTS		250
DEDICATED CIRCUIT		NO

<u>HEAT OUTPUT (MAX)</u>	<u>Btu/hr</u>	<u>Kcal/hr</u>
	1,000	252

<u>CABLE LENGTH (MAX)</u>	<u>Feet</u>	<u>Meters</u>
POWER	6	1.8
DATA	12	3.7

NOTES

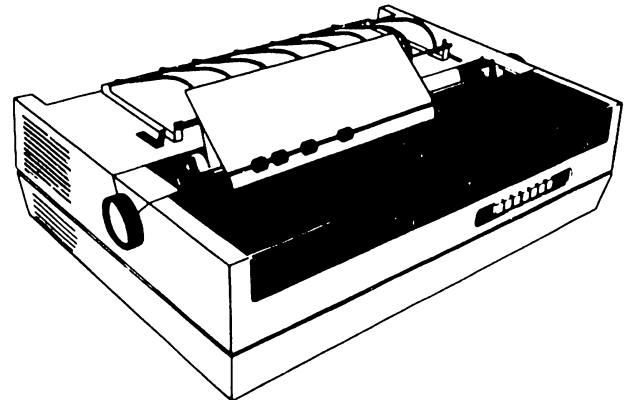
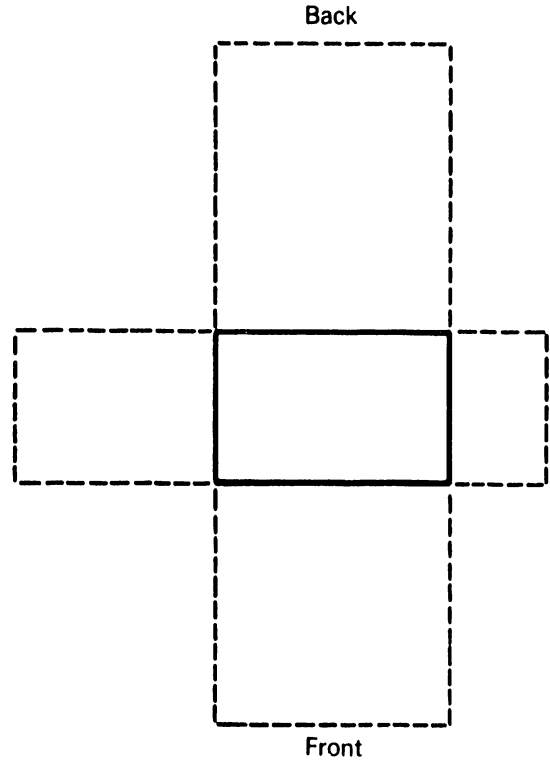

DAISY PRINTER

2281WC

PRODUCT INFORMATION SHEET

<u>DIMENSIONS</u>	<u>Inches</u>	<u>Centimeters</u>
WIDTH	19.75	50.2
HEIGHT	13.5	34.3
DEPTH	20.5	52.0

<u>NET WEIGHT</u>	<u>Pounds</u>	<u>Kilograms</u>
	38.5	17.3

<u>SERVICE CLEARANCES</u>	<u>Inches</u>	<u>Centimeters</u>
FRONT	30	76.2
REAR	0	0
LEFT	12	30.5
RIGHT	12	30.5
TOP	18	45.7

<u>POWER REQUIREMENTS</u>	<u>115V/60Hz</u>	<u>230V/50Hz</u>
AMPS	3.0	1.5
WATTS		65
DEDICATED CIRCUIT		NO

<u>HEAT OUTPUT (MAX)</u>	<u>Btu/hr</u>	<u>Kcal/hr</u>
	614	154.7

<u>CABLE LENGTH (MAX)</u>	<u>Feet</u>	<u>Meters</u>
POWER	8	2.4
DATA	12	3.66

NOTES

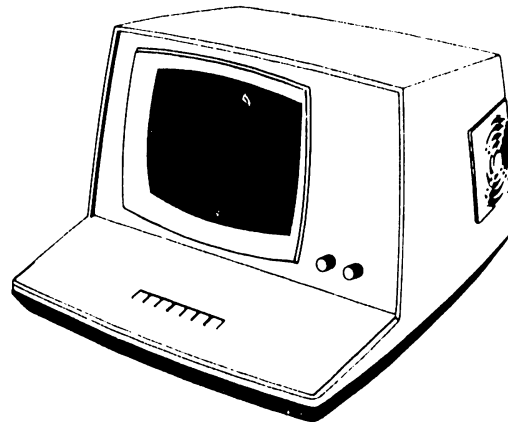
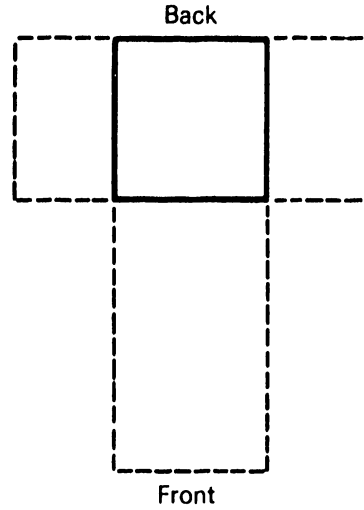

GRAPHIC CRT

2282

PRODUCT INFORMATION SHEET

<u>DIMENSIONS</u>	<u>Inches</u>	<u>Centimeters</u>
WIDTH	20.5	52.1
HEIGHT	22.5	57.2
DEPTH	30.5	77.5

<u>NET WEIGHT</u>	<u>Pounds</u>	<u>Kilograms</u>
	55	24.8

<u>SERVICE CLEARANCES</u>	<u>Inches</u>	<u>Centimeters</u>
FRONT	-	-
REAR	-	-
LEFT	-	-
RIGHT	-	-
TOP	-	-

<u>POWER REQUIREMENTS</u>	<u>115V/60Hz</u>	<u>230V/50Hz</u>
AMPS	-	-
WATTS	-	-
DEDICATED CIRCUIT	-	-

<u>HEAT OUTPUT (MAX)</u>	<u>Btu/hr</u>	<u>Kcal/hr</u>
	-	-

<u>CABLE LENGTH (MAX)</u>	<u>Feet</u>	<u>Meters</u>
POWER	-	-
DATA	-	-

NOTES



Front

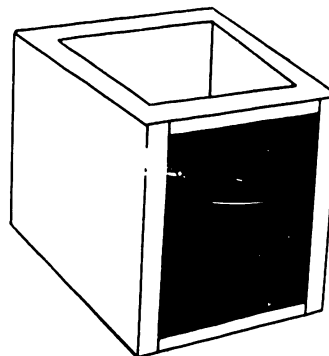

DISK DRIVE STAND (FOR 2260C)

2297

PRODUCT INFORMATION SHEET

<u>DIMENSIONS</u>	<u>Inches</u>	<u>Centimeters</u>
WIDTH	16.5	42.0
HEIGHT	13.25	33.6
DEPTH	22.0	55.9

<u>NET WEIGHT</u>	<u>Pounds</u>	<u>Kilograms</u>
	72.5	32.6

<u>SERVICE CLEARANCES</u>	<u>Inches</u>	<u>Centimeters</u>
FRONT	30	76.2
REAR	12	30.5
LEFT	12	30.5
RIGHT	12	30.5
TOP	14	35.6

<u>POWER REQUIREMENTS</u>	<u>115V/60Hz</u>	<u>230V/50Hz</u>
AMPS	3.0	1.5
WATTS		250
DEDICATED CIRCUIT		NO

<u>HEAT OUTPUT (MAX)</u>	<u>Btu/hr</u>	<u>Kcal/hr</u>
	941	237.1

<u>CABLE LENGTH (MAX)</u>	<u>Feet</u>	<u>Meters</u>
POWER	8	2.4
DATA	-	-

NOTES

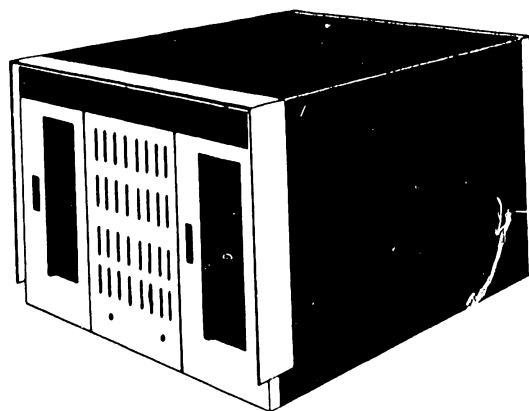
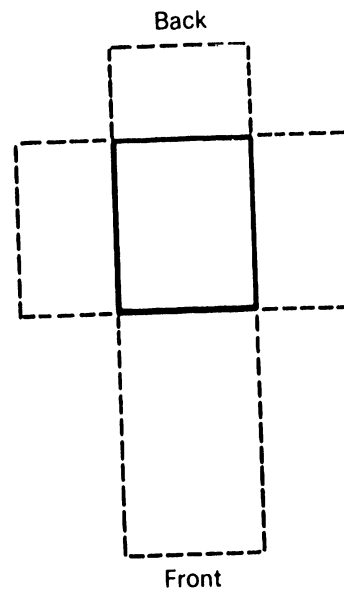

WORD PROCESSING SYSTEM 5 CENTRAL PROCESSOR

5505

**PRODUCT INFORMATION SHEET**

<u>DIMENSIONS</u>	<u>Inches</u>	<u>Centimeters</u>
WIDTH	19.75	50.2
HEIGHT	13.5	34.3
DEPTH	20.5	52.0

<u>NET WEIGHT</u>	<u>Pounds</u>	<u>Kilograms</u>
	54	24.3

<u>SERVICE CLEARANCES</u>	<u>Inches</u>	<u>Centimeters</u>
FRONT	30	76.2
REAR	0	0
LEFT	12	30.5
RIGHT	12	30.5
TOP	16	40.6

<u>POWER REQUIREMENTS</u>	<u>115V/60Hz</u>	<u>230V/50Hz</u>
AMPS	.6	.3
WATTS		70
DEDICATED CIRCUIT		NO

<u>HEAT OUTPUT (MAX)</u>	<u>Btu/hr</u>	<u>Kcal/hr</u>
	512	129

<u>CABLE LENGTH (MAX)</u>	<u>Feet</u>	<u>Meters</u>
POWER	6	1.8
DATA	6	1.8

NOTES

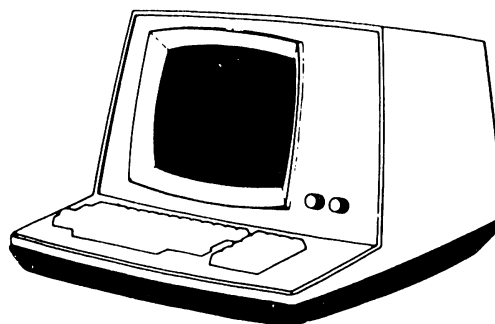
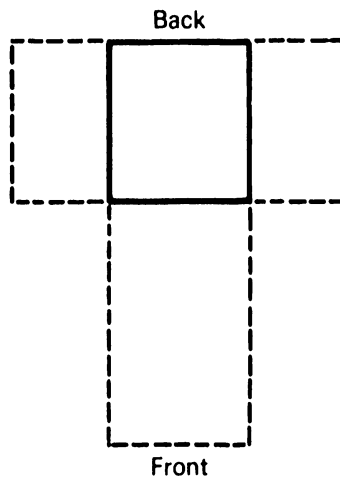

WP5 CRT/WORKSTATION

5506

PRODUCT INFORMATION SHEET

<u>DIMENSIONS</u>	<u>Inches</u>	<u>Centimeters</u>
WIDTH	16.5	42.0
HEIGHT	13.25	33.7
DEPTH	22.0	55.9

<u>NET WEIGHT</u>	<u>Pounds</u>	<u>Kilograms</u>
	72.5	32.9

<u>SERVICE CLEARANCES</u>	<u>Inches</u>	<u>Centimeters</u>
FRONT	30	76.2
REAR	6	15.2
LEFT	12	30.5
RIGHT	12	30.5
TOP	14	35.6

<u>POWER REQUIREMENTS</u>	<u>115V/60Hz</u>	<u>230V/50Hz</u>
AMPS	3.0	1.5
WATTS		250
DEDICATED CIRCUIT		YES

<u>HEAT OUTPUT (MAX)</u>	<u>Btu/hr</u>	<u>Kcal/hr</u>
	941	237.1

<u>CABLE LENGTH (MAX)</u>	<u>Feet</u>	<u>Meters</u>
POWER	6	1.8
DATA	-	-

NOTES

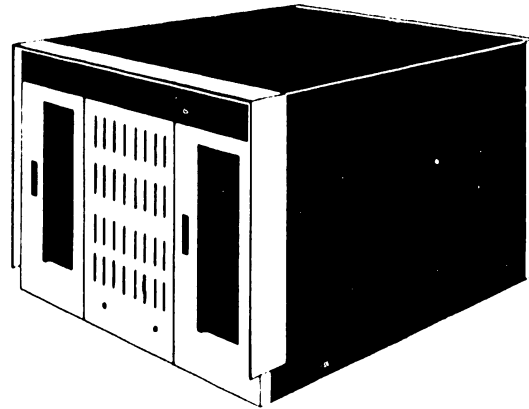
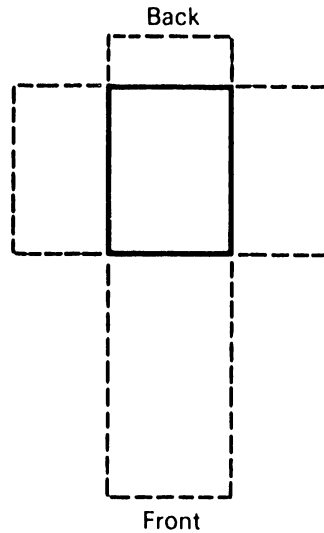

WORD PROCESSING SYSTEM 20 CENTRAL PROCESSOR

5520



PRODUCT INFORMATION SHEET

<u>DIMENSIONS</u>	<u>Inches</u>	<u>Centimeters</u>
WIDTH	29	73.7
HEIGHT	12	30.5
DEPTH	25	63.5

<u>NET WEIGHT</u>	<u>Pounds</u>	<u>Kilograms</u>
	85	38.2

<u>SERVICE CLEARANCES</u>	<u>Inches</u>	<u>Centimeters</u>
FRONT	30	76.2
REAR	36	91.4
LEFT	24	61.0
RIGHT	24	0
TOP	0	0

<u>POWER REQUIREMENTS</u>	<u>115V/60Hz</u>	<u>230V/50Hz</u>
AMPS	4.0 (SB)	2.0 (SB)
WATTS	300	
DEDICATED CIRCUIT		NO

<u>HEAT OUTPUT (MAX)</u>	<u>Btu/hr</u>	<u>Kcal/hr</u>
	1,200	302

<u>CABLE LENGTH (MAX)</u>	<u>Feet</u>	<u>Meters</u>
POWER	6	1.8
DATA	2,000	609.6

NOTES

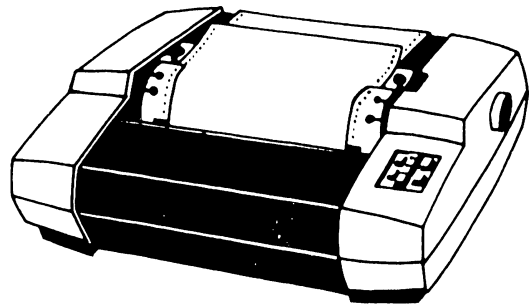
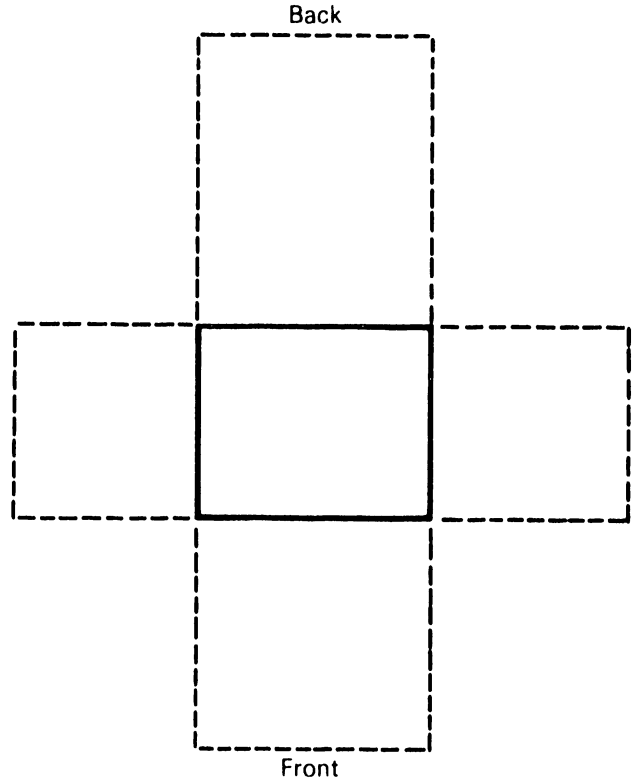

MATRIX PRINTER

5521

**PRODUCT INFORMATION SHEET**

DIMENSIONS                      Inches                      Centimeters

WIDTH	16.5	42.0
HEIGHT	13.25	33.6
DEPTH	22.0	55.9

NET WEIGHT                      Pounds                      Kilograms

20	9.0
----	-----

SERVICE CLEARANCES      Inches                      Centimeters

FRONT	30	76.2
REAR	12	30.5
LEFT	12	30.5
RIGHT	12	30.5
TOP	14	35.6

POWER REQUIREMENTS      115V/60Hz                  230V/50Hz

AMPS	3.0	1.5
WATTS	250	
DEDICATED CIRCUIT	YES	

HEAT OUTPUT (MAX)          Btu/hr                      Kcal/hr

855	215.5
-----	-------

CABLE LENGTH (MAX)      Feet                      Meters

POWER	6	1.8
DATA	-	-

NOTES

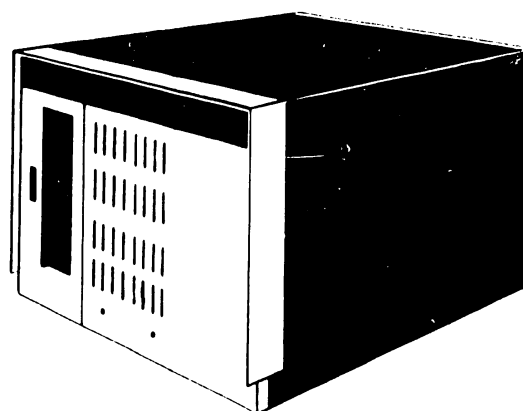
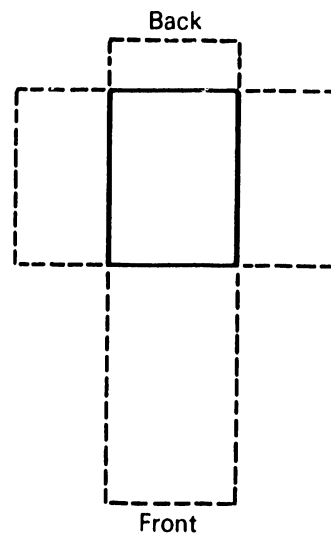

WORD PROCESSING SYSTEM 25 CENTRAL PROCESSOR

5525

**PRODUCT INFORMATION SHEET**

<u>DIMENSIONS</u>	<u>Inches</u>	<u>Centimeters</u>
WIDTH	9.2	23.4
HEIGHT	7.8	19.8
DEPTH	19.3	49.0

<u>NET WEIGHT</u>	<u>Pounds</u>	<u>Kilograms</u>
	18	8.1

<u>SERVICE CLEARANCES</u>	<u>Inches</u>	<u>Centimeters</u>
FRONT	0	0
REAR	6	15.2
LEFT	12	30.5
RIGHT	12	30.5
TOP	15	38.1

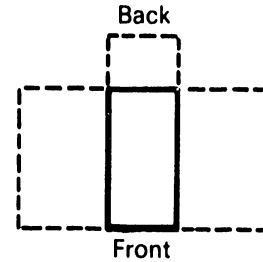

<u>POWER REQUIREMENTS</u>	<u>115V/60Hz</u>	<u>230V/50Hz</u>
AMPS	1.0	.5
WATTS		150
DEDICATED CIRCUIT		NO

<u>HEAT OUTPUT (MAX)</u>	<u>Btu/hr</u>	<u>Kcal/hr</u>
	350	88

<u>CABLE LENGTH (MAX)</u>	<u>Feet</u>	<u>Meters</u>
POWER	6	1.8
DATA	NOTE	NOTE

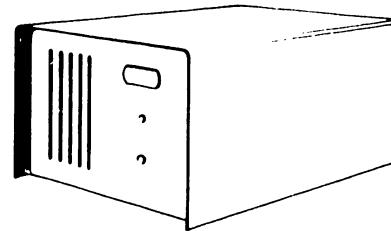

NOTES

12 ft (3.6 m) RS-232-C, CCITT V.24 compatible cable  
 2000 ft (609.6 m) dual coaxial cable to system master

COMMUNICATIONS CONTROLLER

5528

PRODUCT INFORMATION SHEET

<u>DIMENSIONS</u>	<u>Inches</u>	<u>Centimeters</u>
WIDTH	16.5	42.0
HEIGHT	13.25	33.7
DEPTH	22.0	55.9

<u>NET WEIGHT</u>	<u>Pounds</u>	<u>Kilograms</u>
	20	9.0

<u>SERVICE CLEARANCES</u>	<u>Inches</u>	<u>Centimeters</u>
FRONT	30	76.2
REAR	6	15.2
LEFT	12	30.5
RIGHT	12	30.5
TOP	14	35.6

<u>POWER REQUIREMENTS</u>	<u>115V/60Hz</u>	<u>230V/50Hz</u>
AMPS	3.0	1.5
WATTS		250
DEDICATED CIRCUIT		YES

<u>HEAT OUTPUT (MAX)</u>	<u>Btu/hr</u>	<u>Kcal/hr</u>
	855	215.5

<u>CABLE LENGTH (MAX)</u>	<u>Feet</u>	<u>Meters</u>
POWER	6	1.8
DATA	-	-

NOTES

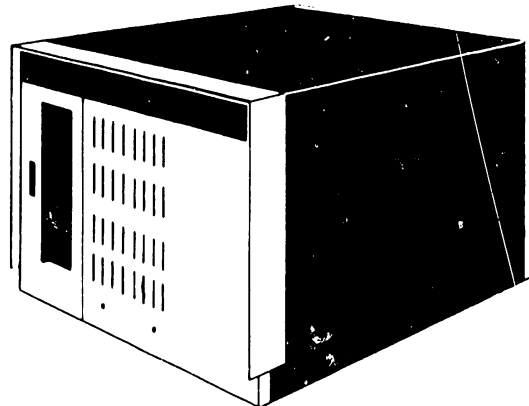
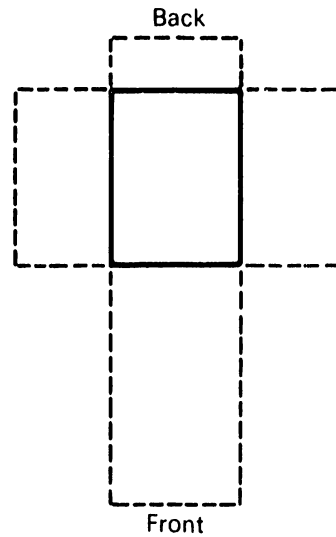

WORD PROCESSING SYSTEM 30 CENTRAL PROCESSOR

5530

D-40

PRODUCT INFORMATION SHEET

<u>DIMENSIONS</u>	<u>Inches</u>	<u>Centimeters</u>
WIDTH	24	61.0
HEIGHT	10	25.4
DEPTH	18	45.7

<u>NET WEIGHT</u>	<u>Pounds</u>	<u>Kilograms</u>
	68	30.6

<u>SERVICE CLEARANCES</u>	<u>Inches</u>	<u>Centimeters</u>
FRONT	30	76.2
REAR	30	76.2
LEFT	12	30.5
RIGHT	24	61.0
TOP	-	-

<u>POWER REQUIREMENTS</u>	<u>115V/60Hz</u>	<u>230V/50Hz</u>
AMPS	1.5 (SB)	.8 (SB)
WATTS	150	
DEDICATED CIRCUIT	NO	

<u>HEAT OUTPUT (MAX)</u>	<u>Btu/hr</u>	<u>Kcal/hr</u>
	600	151.2

<u>CABLE LENGTH (MAX)</u>	<u>Feet</u>	<u>Meters</u>
POWER	6	1.8
DATA	25	7.6
	NOTE	

NOTES  
2000 ft needs interface unit

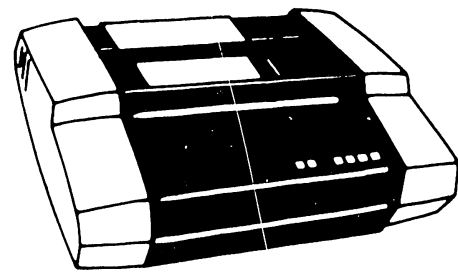
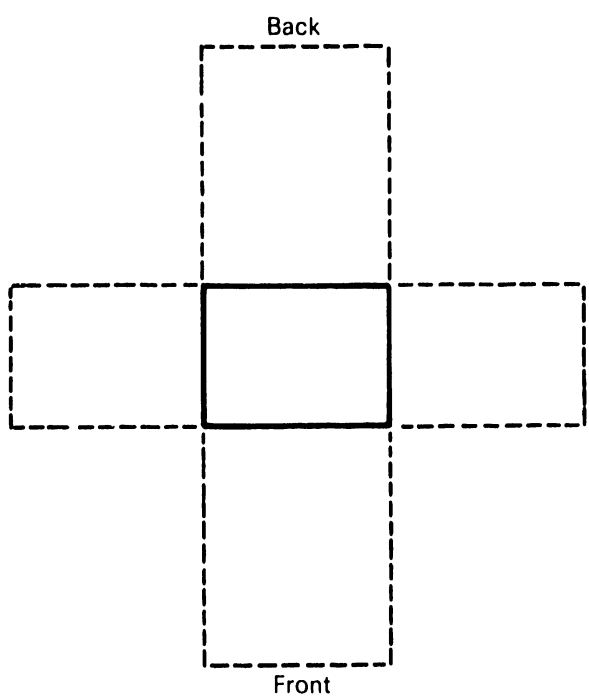

MATRIX CHARACTER PRINTER

5531-2

**PRODUCT INFORMATION SHEET**

<u>DIMENSIONS</u>	<u>Inches</u>	<u>Centimeters</u>
WIDTH	19.75	50.2
HEIGHT	13.5	34.3
DEPTH	20.5	52.0

<u>NET WEIGHT</u>	<u>Pounds</u>	<u>Kilograms</u>
	54	24.3

<u>SERVICE CLEARANCES</u>	<u>Inches</u>	<u>Centimeters</u>
FRONT	30	76.2
REAR	0	0
LEFT	12	30.5
RIGHT	12	30.5
TOP	16	40.6

<u>POWER REQUIREMENTS</u>	<u>115V/60Hz</u>	<u>230V/50Hz</u>
AMPS	2.0	1.0
WATTS		177
DEDICATED CIRCUIT		NO

<u>HEAT OUTPUT (MAX)</u>	<u>Btu/hr</u>	<u>Kcal/hr</u>
	605	152.5

<u>CABLE LENGTH (MAX)</u>	<u>Feet</u>	<u>Meters</u>
POWER	7	2.1
DATA	2,000	609.6

NOTES

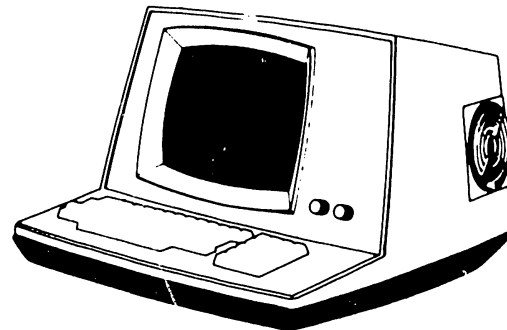
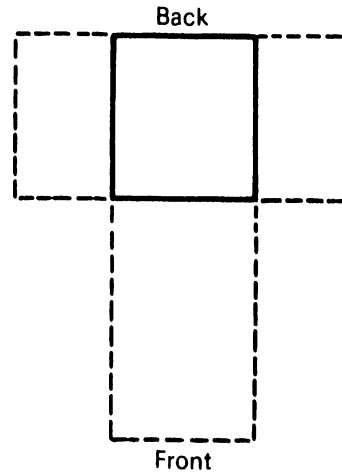

SERIAL CRT/WORKSTATION

5536

**PRODUCT INFORMATION SHEET**

<u>DIMENSIONS</u>	<u>Inches</u>	<u>Centimeters</u>
WIDTH	25.0	63.5
HEIGHT	NOTE	
DEPTH	19.5	49.5

<u>NET WEIGHT</u>	<u>Pounds</u>	<u>Kilograms</u>
	70	31.5

<u>SERVICE CLEARANCES</u>	<u>Inches</u>	<u>Centimeters</u>
FRONT	30	76.2
REAR	30	76.2
LEFT	24	61.0
RIGHT	12	30.5
TOP	0	0

<u>POWER REQUIREMENTS</u>	<u>115V/60Hz</u>	<u>230V/50Hz</u>
AMPS	3.0 (SB)	1.5 (SB)
WATTS		250
DEDICATED CIRCUIT		NO

<u>HEAT OUTPUT (MAX)</u>	<u>Btu/hr</u>	<u>Kcal/hr</u>
	1,000	252

<u>CABLE LENGTH (MAX)</u>	<u>Feet</u>	<u>Meters</u>
POWER	6	1.8
DATA	12	3.7

NOTES

Height without forms feeder:  
9 in. (22.9 cm)  
Height with forms feeder:  
12.5 in (31.8 cm)

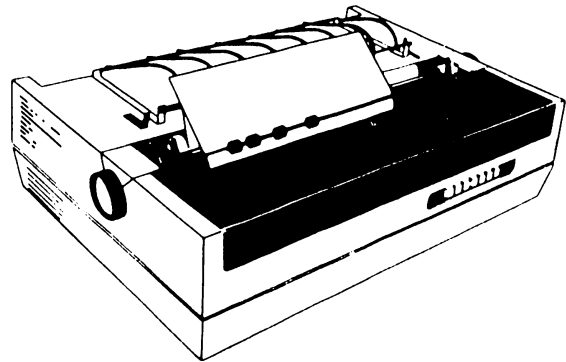
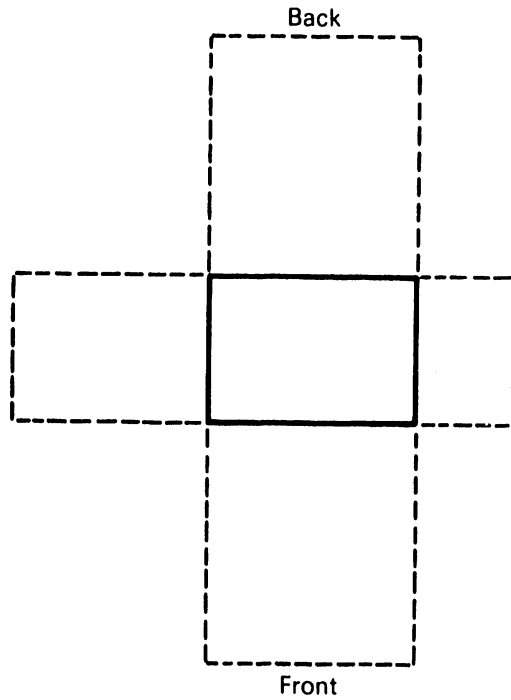

DAISY PRINTER

5541W

**PRODUCT INFORMATION SHEET**

<u>DIMENSIONS</u>	<u>Inches</u>	<u>Centimeters</u>
WIDTH	28.75	73.0
HEIGHT	11.0	27.9
DEPTH	19.5	49.5

<u>NET WEIGHT</u>	<u>Pounds</u>	<u>Kilograms</u>
	70	31.8

<u>SERVICE CLEARANCES</u>	<u>Inches</u>	<u>Centimeters</u>
FRONT	30	76.2
REAR	36	91.4
LEFT	24	61.0
RIGHT	12	30.5
TOP	0	0

<u>POWER REQUIREMENTS</u>	<u>115V/60Hz</u>	<u>230V/50Hz</u>
AMPS	3.0	1.5
WATTS		250
DEDICATED CIRCUIT		NO

<u>HEAT OUTPUT (MAX)</u>	<u>Btu/hr</u>	<u>Kcal/hr</u>
	1,000	252

<u>CABLE LENGTH (MAX)</u>	<u>Feet</u>	<u>Meters</u>
POWER	6	1.8
DATA	50	15.25

NOTES

\*With Forms Feeder.  
Without Forms Feeder:  
9.0 in (22.9 cm)

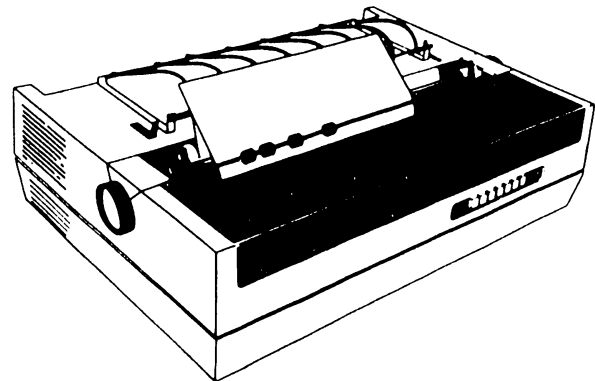
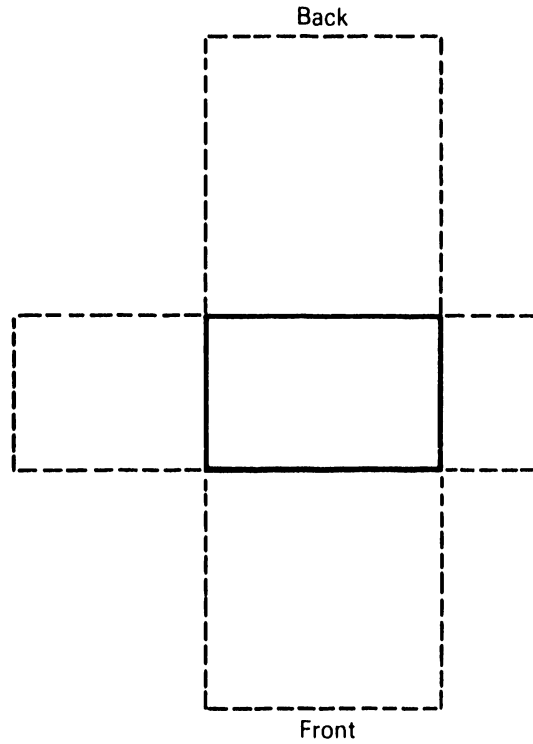

WIDE CARRIAGE DAISY PRINTER

5541WC



**PRODUCT INFORMATION SHEET**

<u>DIMENSIONS</u>	<u>Inches</u>	<u>Centimeters</u>
WIDTH	48.0	121.9
HEIGHT	32.0	81.3
DEPTH	25.5	64.8

<u>NET WEIGHT</u>	<u>Pounds</u>	<u>Kilograms</u>
	550	247.5

<u>SERVICE CLEARANCES</u>	<u>Inches</u>	<u>Centimeters</u>
FRONT	24	61.0
REAR	30	76.2
LEFT	30	76.2
RIGHT	30	76.2
TOP	24	61.0

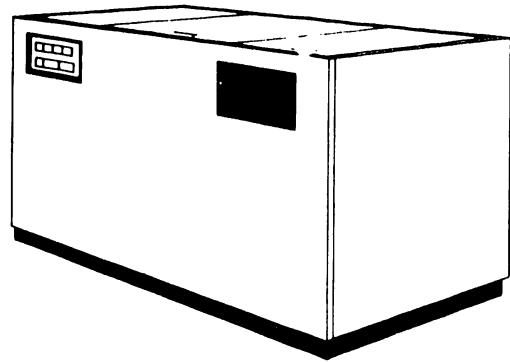

<u>POWER REQUIREMENTS</u>	<u>115V/60Hz</u>	<u>230V/50Hz</u>
AMPS	7.0	3.5
WATTS		805
DEDICATED CIRCUIT		YES

<u>HEAT OUTPUT (MAX)</u>	<u>Btu/hr</u>	<u>Kcal/hr</u>
	4,000	1,008

<u>CABLE LENGTH (MAX)</u>	<u>Feet</u>	<u>Meters</u>
POWER	6	1.8
DATA	2,000	609.6

NOTES

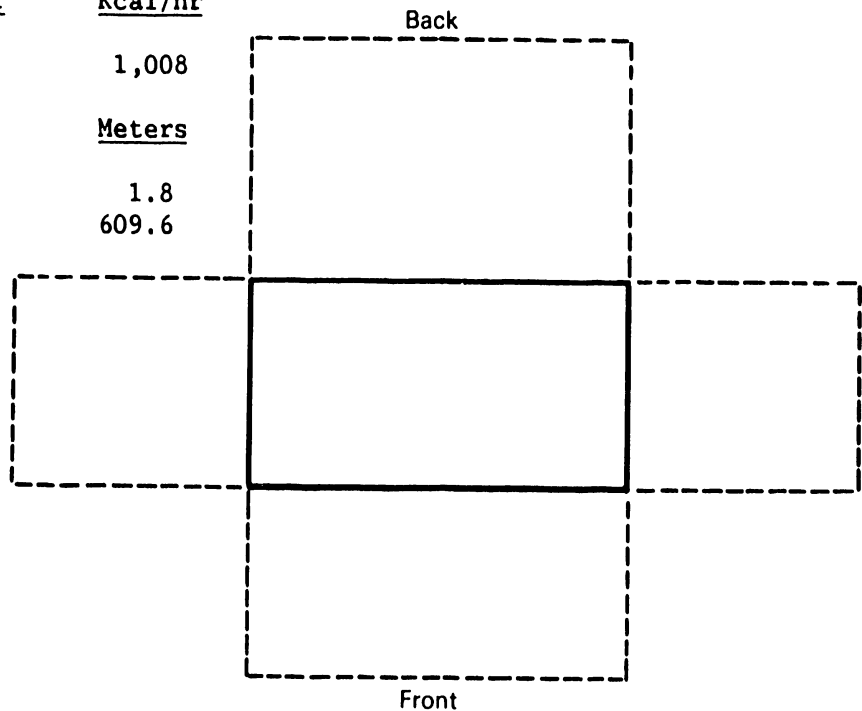

TYPESETTER

5548z

**PRODUCT INFORMATION SHEET**

<u>DIMENSIONS</u>	<u>Inches</u>	<u>Centimeters</u>
WIDTH	36.5	92.7
HEIGHT	42.0	106.7
DEPTH	32.0	81.3

<u>NET WEIGHT</u>	<u>Pounds</u>	<u>Kilograms</u>
	570	256.5

<u>SERVICE CLEARANCES</u>	<u>Inches</u>	<u>Centimeters</u>
FRONT	36	91.4
REAR	30	76.2
LEFT	24	61.0
RIGHT	24	61.0
TOP	61	154.9

<u>POWER REQUIREMENTS</u>	<u>115V/60Hz</u>	<u>230V/50Hz</u>
AMPS	5.5	3
WATTS		690
DEDICATED CIRCUIT		NO

<u>HEAT OUTPUT (MAX)</u>	<u>Btu/hr</u>	<u>Kcal/hr</u>
	2,700	680.4

<u>CABLE LENGTH (MAX)</u>	<u>Feet</u>	<u>Meters</u>
POWER	7	2.1
DATA	2,000	609.6

NOTES

Recommended duty cycle 50%

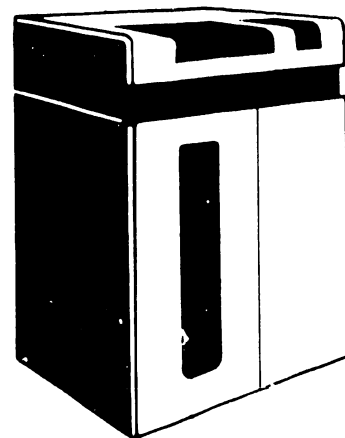
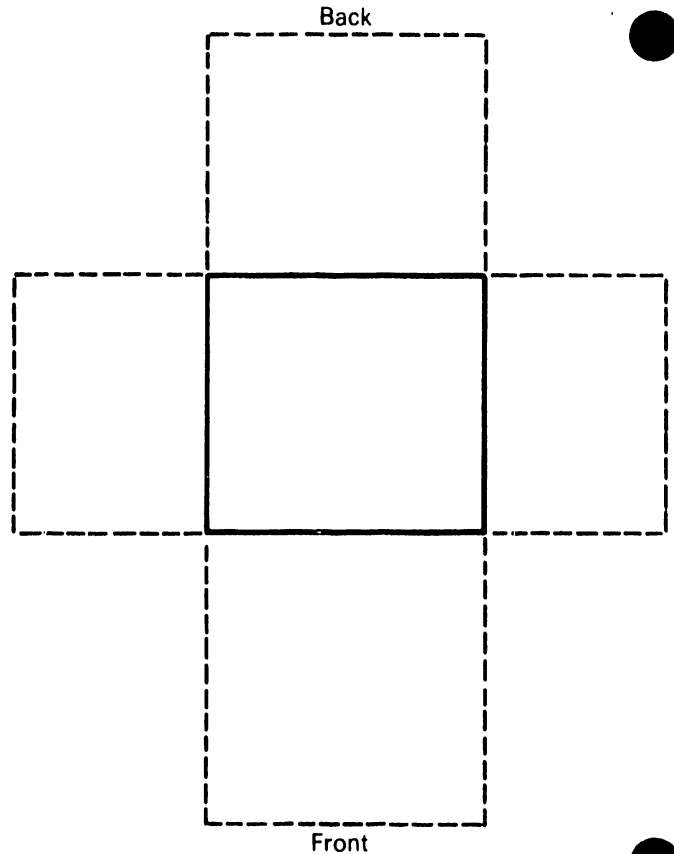

600-LPM CHAIN PRINTER

5570

**PRODUCT INFORMATION SHEET**

<u>DIMENSIONS</u>	<u>Inches</u>	<u>Centimeters</u>
WIDTH	36.5	92.7
HEIGHT	42.0	106.7
DEPTH	32.0	81.3

<u>NET WEIGHT</u>	<u>Pounds</u>	<u>Kilograms</u>
	570	256.5

<u>SERVICE CLEARANCES</u>	<u>Inches</u>	<u>Centimeters</u>
FRONT	36	91.4
REAR	30	76.2
LEFT	24	61.0
RIGHT	24	61.0
TOP	61	154.9

<u>POWER REQUIREMENTS</u>	<u>115V/60Hz</u>	<u>230V/50Hz</u>
AMPS	5.5	3.0
WATTS		690
DEDICATED CIRCUIT		NO

<u>HEAT OUTPUT (MAX)</u>	<u>Btu/hr</u>	<u>Kcal/hr</u>
	2,700	680.4

<u>CABLE LENGTH (MAX)</u>	<u>Feet</u>	<u>Meters</u>
POWER	7	2.1
DATA	2,000	609.6

NOTES

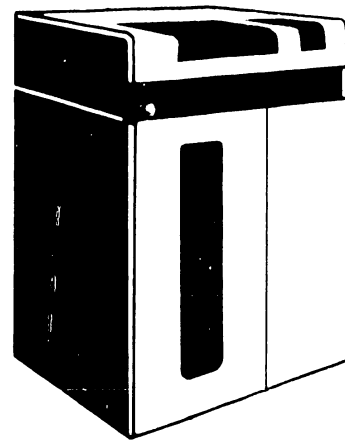
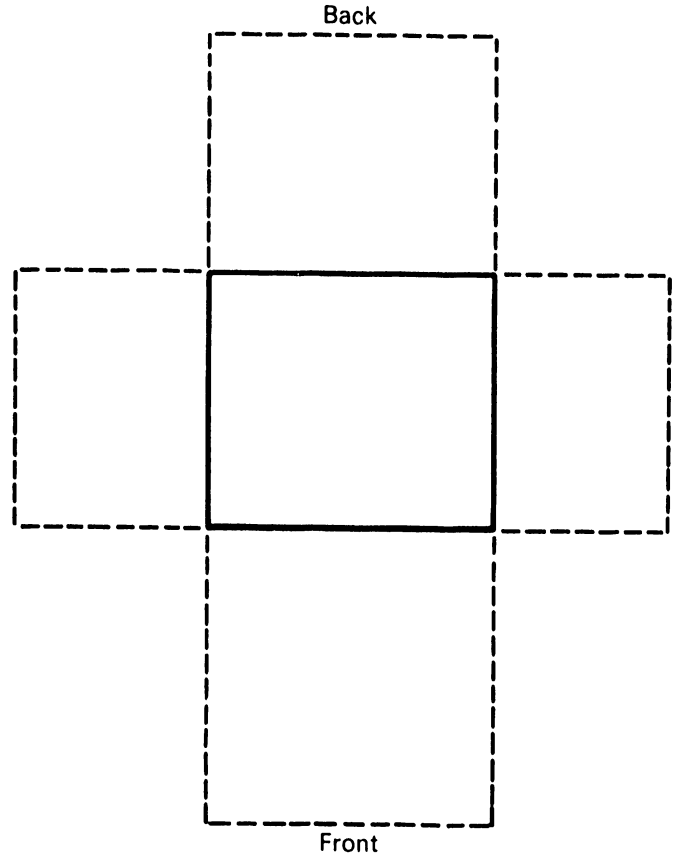

425-LPM CHAIN PRINTER

5571

PRODUCT INFORMATION SHEET

<u>DIMENSIONS</u>	<u>Inches</u>	<u>Centimeters</u>
WIDTH	30.5	77.5
HEIGHT	43.75	111.1
DEPTH	25.1	63.7

<u>NET WEIGHT</u>	<u>Pounds</u>	<u>Kilograms</u>
	198	89.1

<u>SERVICE CLEARANCES</u>	<u>Inches</u>	<u>Centimeters</u>
FRONT	30	76.2
REAR	30	76.2
LEFT	24	61.0
RIGHT	12	30.5
TOP	58.75	149.2

<u>POWER REQUIREMENTS</u>	<u>115V/60Hz</u>	<u>230V/50Hz</u>
AMPS	3.0	1.5
WATTS		350
DEDICATED CIRCUIT		NO

<u>HEAT OUTPUT (MAX)</u>	<u>Btu/hr</u>	<u>Kcal/hr</u>
	1,200	302.4

<u>CABLE LENGTH (MAX)</u>	<u>Feet</u>	<u>Meters</u>
POWER	6	1.8
DATA	2,000	609.6

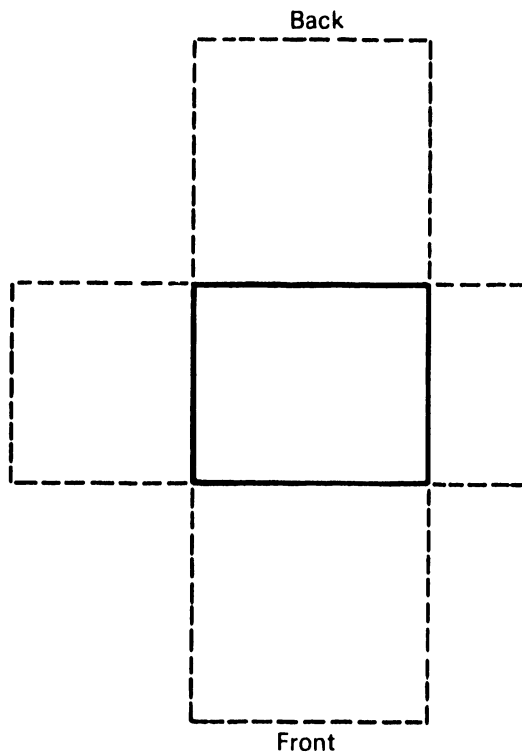

NOTES

\*Height with stand, cover closed.  
 Height without stand:  
 14.5 in. (36.8 cm) cover closed  
 29.5 in. (74.9 cm) cover open

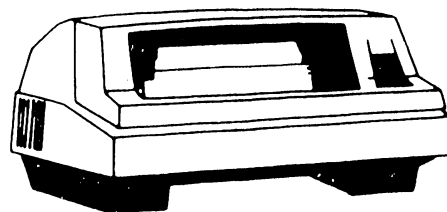

BAND PRINTER

5573

**PRODUCT INFORMATION SHEET**

DIMENSIONS                      Inches                      Centimeters

WIDTH	30.5	77.5
HEIGHT*	43.75	111.1
DEPTH	25.1	63.7

NET WEIGHT                      Pounds                      Kilograms

198	89.1
-----	------

SERVICE CLEARANCES      Inches                      Centimeters

FRONT	30	76.2
REAR	30	76.2
LEFT	24	61.0
RIGHT	12	30.5
TOP	58.75	149.2

POWER REQUIREMENTS      115V/60Hz                  230V/50Hz

AMPS	3.0	1.5
WATTS		350
DEDICATED CIRCUIT		NO

HEAT OUTPUT (MAX)          Btu/hr                      Kcal/hr

1,200	302.4
-------	-------

CABLE LENGTH (MAX)      Feet                      Meters

POWER	6	1.8
DATA	2,000	609.6

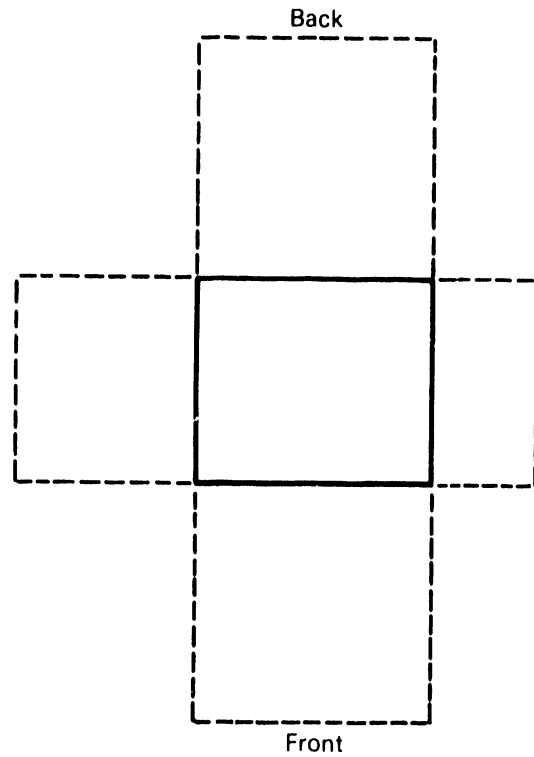

NOTES

\*Height with stand, cover closed.  
 Height without stand:  
 14.5 in. (36.8 cm) cover closed  
 29.5 in. (74.9 cm) cover open

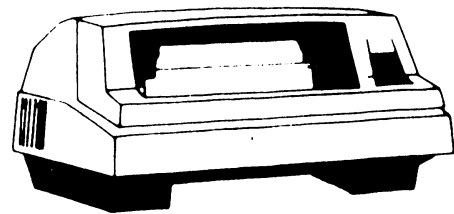

BAND PRINTER

5574

**PRODUCT INFORMATION SHEET**

<u>DIMENSIONS</u>	<u>Inches</u>	<u>Centimeters</u>
WIDTH	24	61.0
HEIGHT*	14	35.6
DEPTH	22	55.9

<u>NET WEIGHT</u>	<u>Pounds</u>	<u>Kilograms</u>
	64	28.8

<u>SERVICE CLEARANCES</u>	<u>Inches</u>	<u>Centimeters</u>
FRONT	30	76.2
REAR	36	91.4
LEFT	24	61.0
RIGHT	12	30.5
TOP	0	0

<u>POWER REQUIREMENTS</u>	<u>115V/60Hz</u>	<u>230V/50Hz</u>
AMPS	3.0 (SB)	1.5 (SB)
WATTS		250
DEDICATED CIRCUIT	NO	

<u>HEAT OUTPUT (MAX)</u>	<u>Btu/hr</u>	<u>Kcal/hr</u>
	1,000	252

<u>CABLE LENGTH (MAX)</u>	<u>Feet</u>	<u>Meters</u>
POWER	6	1.8
DATA	25	7.6

NOTES

\*Height with fc ms feeder  
 Height without forms feeder:  
 12 in. (30.5 cm)

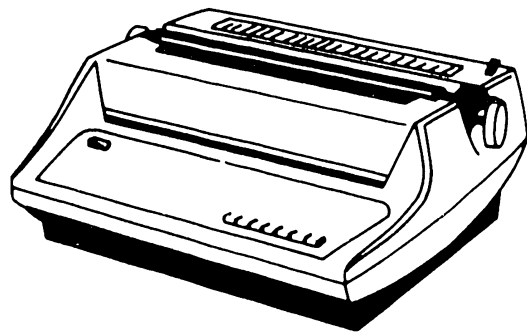
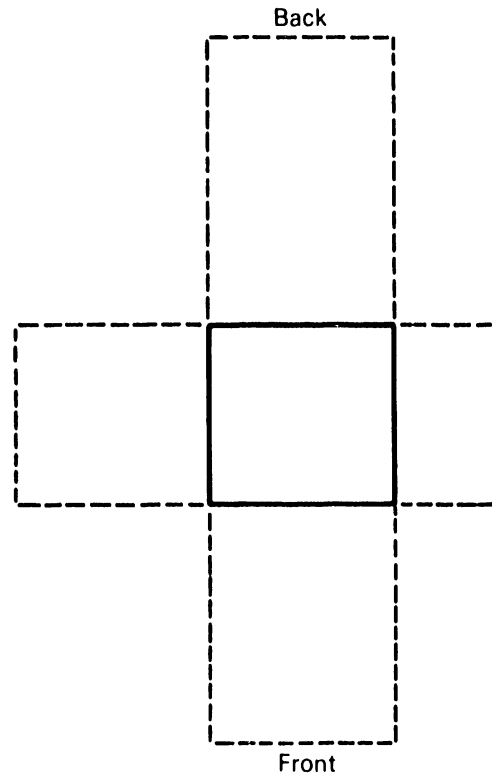

DAISY WHEEL PRINTER

5581

**PRODUCT INFORMATION SHEET**

<u>DIMENSIONS</u>	<u>Inches</u>	<u>Centimeters</u>
WIDTH	41.5	105.4
HEIGHT*	12.5	31.8
DEPTH	20.5	52.1

<u>NET WEIGHT</u>	<u>Pounds</u>	<u>Kilograms</u>
	125	56.25

<u>SERVICE CLEARANCES</u>	<u>Inches</u>	<u>Centimeters</u>
FRONT	30	76.2
REAR	36	91.4
LEFT	24	61.0
RIGHT	12	30.5
TOP	0	0

<u>POWER REQUIREMENTS</u>	<u>115V/60Hz</u>	<u>230V/50Hz</u>
AMPS	6.0 (SB)	3.0 (SB)
WATTS	500	
DEDICATED CIRCUIT	NO	

<u>HEAT OUTPUT (MAX)</u>	<u>Btu/hr</u>	<u>Kcal/hr</u>
	1,705	429.7

<u>CABLE LENGTH (MAX)</u>	<u>Feet</u>	<u>Meters</u>
POWER	6	1.8
DATA	2,000	609.6

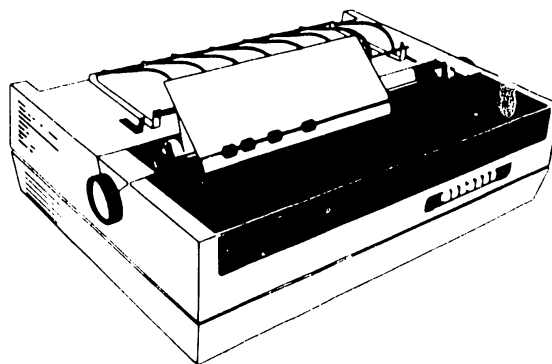
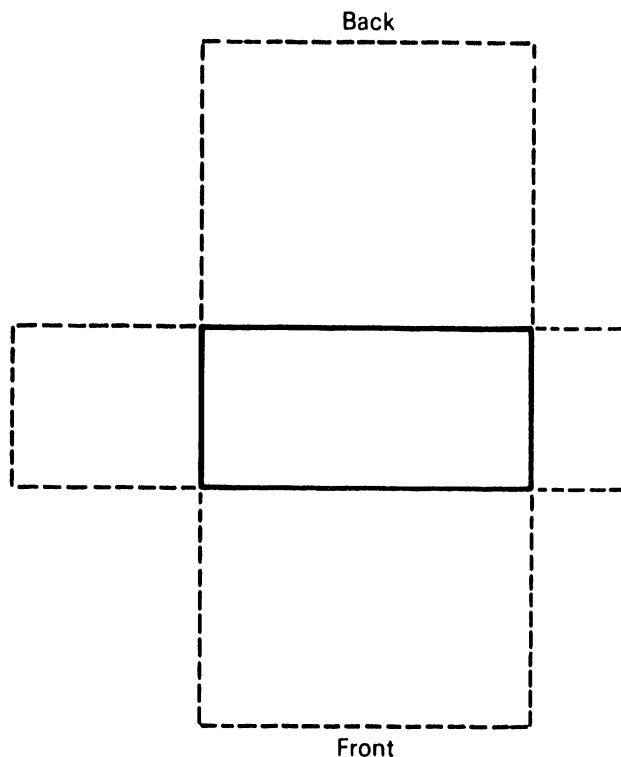

NOTES

\*Height with forms feeder  
 Height without forms feeder  
 9 in (22.9 cm)

TWIN-HEAD DAISY PRINTER

5581WD

PRODUCT INFORMATION SHEET

DIMENSIONS                      Inches                      Centimeters

WIDTH	21.2	53.0
HEIGHT	14.2	36.2
DEPTH	23.0	58.4

NET WEIGHT                      Pounds                      Kilograms

70	31.5
----	------

SERVICE CLEARANCES      Inches                      Centimeters

FRONT	25	64
REAR	18	46
LEFT	10	25
RIGHT	10	25
TOP	20	51

POWER REQUIREMENTS      115V/60Hz                  230V/50Hz

AMPS	4.0	2.0
WATTS		460
DEDICATED CIRCUIT		YES

HEAT OUTPUT (MAX)              Btu/hr                      Kcal/hr

1,877	473
-------	-----

CABLE LENGTH (MAX)              Feet                      Meters

POWER	9.5	2.9
DATA	-	-

NOTES

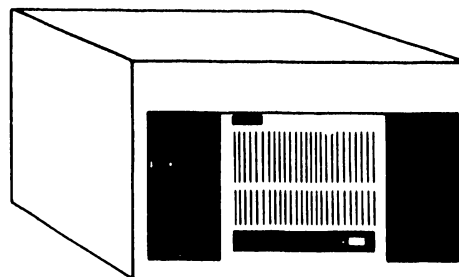
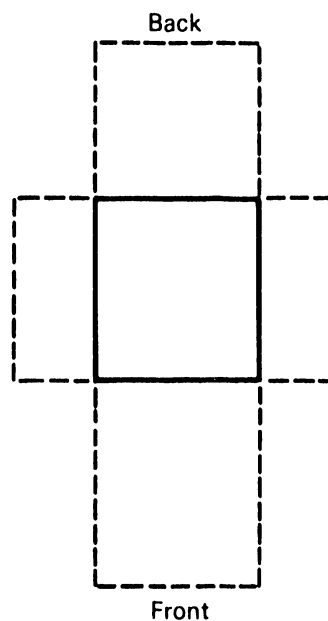

OIS SYSTEM 105 CENTRAL PROCESSOR

6505



**PRODUCT INFORMATION SHEET**

<u>DIMENSIONS</u>	<u>Inches</u>	<u>Centimeters</u>
WIDTH	21.2	53.0
HEIGHT	14.2	36.2
DEPTH	23.0	54.4

<u>NET WEIGHT</u>	<u>Pounds</u>	<u>Kilograms</u>
	70	31.5

<u>SERVICE CLEARANCES</u>	<u>Inches</u>	<u>Centimeters</u>
FRONT	25	64
REAR	18	46
LEFT	10	25
RIGHT	10	25
TOP	20	51

<u>POWER REQUIREMENTS</u>	<u>115V/60Hz</u>	<u>230V/50Hz</u>
AMPS	4.0	2.0
WATTS		460
DEDICATED CIRCUIT		YES

<u>HEAT OUTPUT (MAX)</u>	<u>Btu/hr</u>	<u>Kcal/hr</u>
	1,877	473

<u>CABLE LENGTH (MAX)</u>	<u>Feet</u>	<u>Meters</u>
POWER	9.5	2.9
DATA	-	-

NOTES

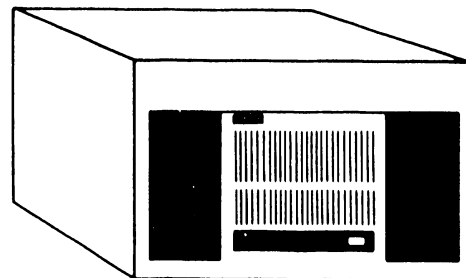
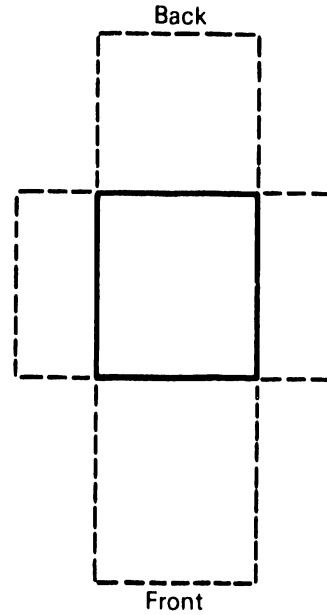

OIS SYSTEM 115 CENTRAL PROCESSOR

6515

**PRODUCT INFORMATION SHEET**

<u>DIMENSIONS</u>	<u>Inches</u>	<u>Centimeters</u>
WIDTH	16.5	42.0
HEIGHT	13.25	33.6
DEPTH	22.0	55.9

<u>NET WEIGHT</u>	<u>Pounds</u>	<u>Kilograms</u>
	20	9.0

<u>SERVICE CLEARANCES</u>	<u>Inches</u>	<u>Centimeters</u>
FRONT	30	76.2
REAR	6	15.2
LEFT	12	30.5
RIGHT	12	30.5
TOP	14	35.6

<u>POWER REQUIREMENTS</u>	<u>115V/60Hz</u>	<u>230V/50Hz</u>
AMPS	2.0	1.0
WATTS		250
DEDICATED CIRCUIT		YES

<u>HEAT OUTPUT (MAX)</u>	<u>Btu/hr</u>	<u>Kcal/hr</u>
	855	215.5

<u>CABLE LENGTH (MAX)</u>	<u>Feet</u>	<u>Meters</u>
POWER	8	2.4
DATA	-	-

NOTES

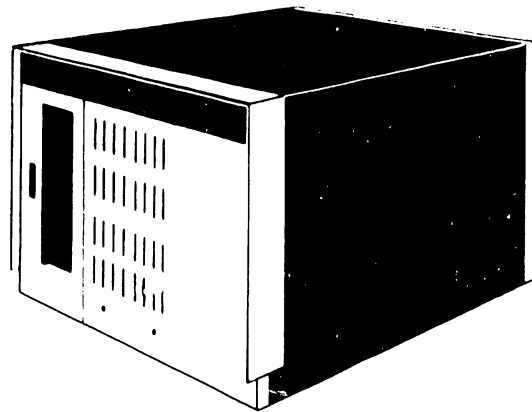
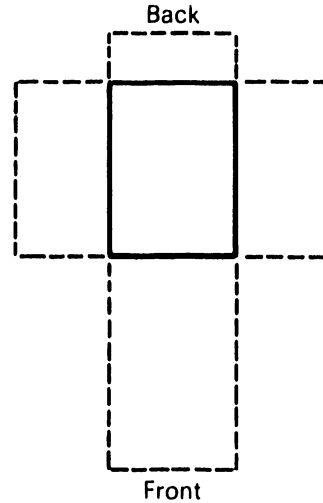

OIS SYSTEM 125 CENTRAL PROCESSOR

6525

PRODUCT INFORMATION SHEET

<u>DIMENSIONS</u>	<u>Inches</u>	<u>Centimeters</u>
WIDTH	16.5	42.0
HEIGHT	13.25	33.6
DEPTH	22.0	55.9
<u>NET WEIGHT</u>	<u>Pounds</u>	<u>Kilograms</u>
	20	9.0
<u>SERVICE CLEARANCES</u>	<u>Inches</u>	<u>Centimeters</u>
FRONT	30	76.2
REAR	12	30.5
LEFT	12	30.5
RIGHT	12	30.5
TOP	14	35.6
<u>POWER REQUIREMENTS</u>	<u>115V/60Hz</u>	<u>230V/50Hz</u>
AMPS	2.0	1.0
WATTS		250
DEDICATED CIRCUIT		YES
<u>HEAT OUTPUT (MAX)</u>	<u>Btu/hr</u>	<u>Kcal/hr</u>
	2.0	215.5
<u>CABLE LENGTH (MAX)</u>	<u>Feet</u>	<u>Meters</u>
POWER	8	2.4
DATA	-	-

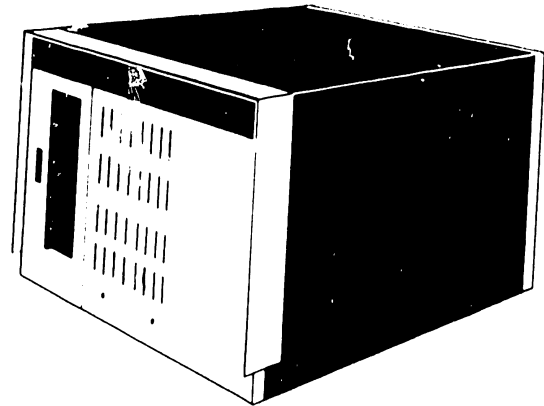
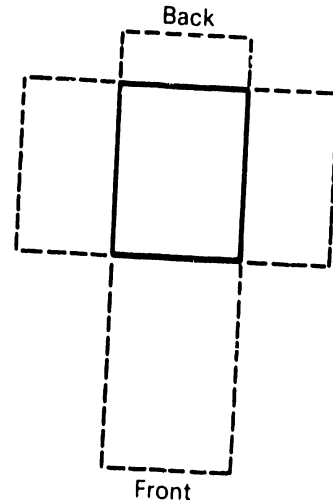

NOTES

OIS SYSTEM 130 CENTRAL PROCESSOR

6530

PRODUCT INFORMATION SHEET

<u>DIMENSIONS</u>	<u>Inches</u>	<u>Centimeters</u>
WIDTH	21.2	53.0
HEIGHT	14.2	36.2
DEPTH	23.0	58.4

<u>NET WEIGHT</u>	<u>Pounds</u>	<u>Kilograms</u>
	40	18.0

<u>SERVICE CLEARANCES</u>	<u>Inches</u>	<u>Centimeters</u>
FRONT	25	64
REAR	18	46
LEFT	10	25
RIGHT	10	25
TOP	20	51

<u>POWER REQUIREMENTS</u>	<u>115V/60Hz</u>	<u>230V/50Hz</u>
AMPS	4.0	2.0
WATTS		460
DEDICATED CIRCUIT		YES

<u>HEAT OUTPUT (MAX)</u>	<u>Btu/hr</u>	<u>Kcal/hr</u>
	1,500	378

<u>CABLE LENGTH (MAX)</u>	<u>Feet</u>	<u>Meters</u>
POWER	9.5	2.9
DATA	-	-

NOTES

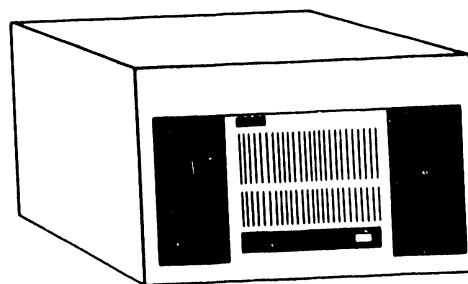
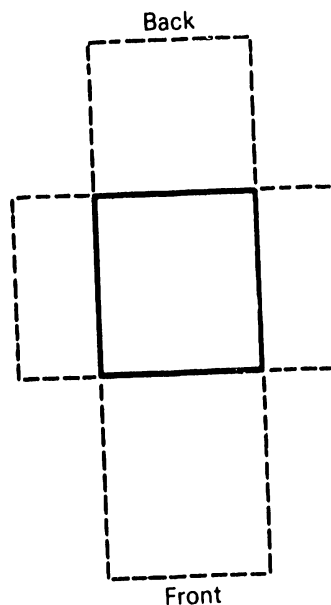

OIS SYSTEM 125A CENTRAL PROCESSOR

6525A

PRODUCT INFORMATION SHEET

<u>DIMENSIONS</u>	<u>Inches</u>	<u>Centimeters</u>
WIDTH	21.2	53.0
HEIGHT	14.2	36.2
DEPTH	23.0	58.4

<u>NET WEIGHT</u>	<u>Pounds</u>	<u>Kilograms</u>
	40	18.0

<u>SERVICE CLEARANCES</u>	<u>Inches</u>	<u>Centimeters</u>
FRONT	25	64
REAR	18	46
LEFT	10	25
RIGHT	10	25
TOP	20	51

<u>POWER REQUIREMENTS</u>	<u>115V/60Hz</u>	<u>230V/50Hz</u>
AMPS	4.0	2.0
WATTS		460
DEDICATED CIRCUIT		YES

<u>HEAT OUTPUT (MAX)</u>	<u>Btu/hr</u>	<u>Kcal/hr</u>
	1500	378

<u>CABLE LENGTH (MAX)</u>	<u>Feet</u>	<u>Meters</u>
POWER	9.5	2.9
DATA	-	-

NOTES

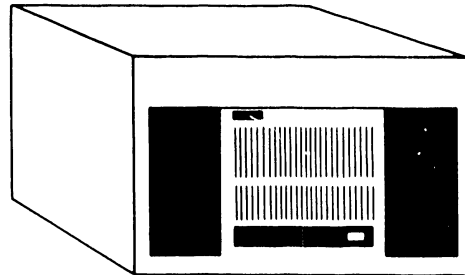
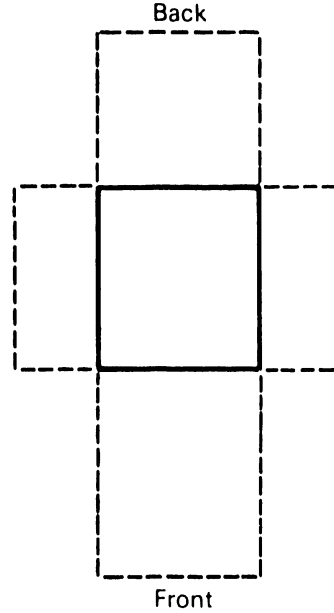

OIS SYSTEM 130A CENTRAL PROCESSOR

6530A

PRODUCT INFORMATION SHEET

<u>DIMENSIONS</u>	<u>Inches</u>	<u>Centimeters</u>
WIDTH	24.0	61.0
HEIGHT	28.5	72.4
DEPTH	30.0	76.2

<u>NET WEIGHT</u>	<u>Pounds</u>	<u>Kilograms</u>
	200	90.0

<u>SERVICE CLEARANCES</u>	<u>Inches</u>	<u>Centimeters</u>
FRONT	30	76.2
REAR	30	76.2
LEFT	0	0
RIGHT	0	0
TOP	18	45.7

<u>POWER REQUIREMENTS</u>	<u>115V/60Hz</u>	<u>230V/50Hz</u>
AMPS	4.0	2
WATTS		460
DEDICATED CIRCUIT		YES

<u>HEAT OUTPUT (MAX)</u>	<u>Btu/hr</u>	<u>Kcal/hr</u>
	1,700	428.4

<u>CABLE LENGTH (MAX)</u>	<u>Feet</u>	<u>Meters</u>
POWER	6	1.8
DATA	-	-

NOTES

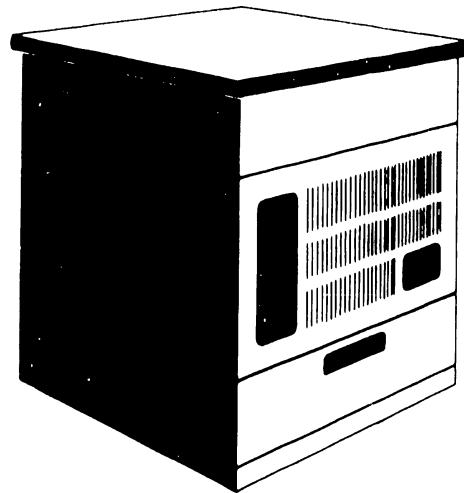
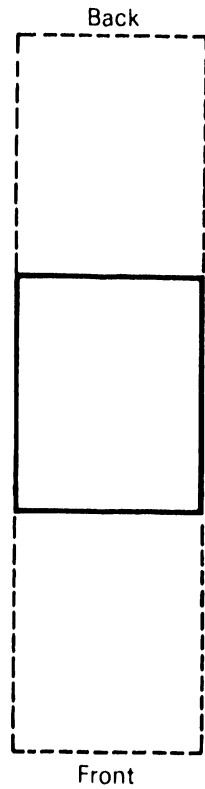

OIS SYSTEM 140 CENTRAL PROCESSOR

PRODUCT INFORMATION SHEET

<u>DIMENSIONS</u>	<u>Inches</u>	<u>Centimeters</u>
WIDTH	24.0	61.0
HEIGHT	28.5	72.4
DEPTH	30.0	76.4
<u>NET WEIGHT</u>	<u>Pounds</u>	<u>Kilograms</u>
	200	90.0
<u>SERVICE CLEARANCES</u>	<u>Inches</u>	<u>Centimeters</u>
FRONT	30	76.2
REAR	30	76.2
LEFT	0	0
RIGHT	0	0
TOP	18	45.7
<u>POWER REQUIREMENTS</u>	<u>115V/60Hz</u>	<u>230V/50Hz</u>
AMPS	3.0	1.5
WATTS		345
DEDICATED CIRCUIT		YES
<u>HEAT OUTPUT (MAX)</u>	<u>Btu/hr</u>	<u>Kcal/hr</u>
	1190	299.9
<u>CABLE LENGTH (MAX)</u>	<u>Feet</u>	<u>Meters</u>
POWER DATA	6	1.8

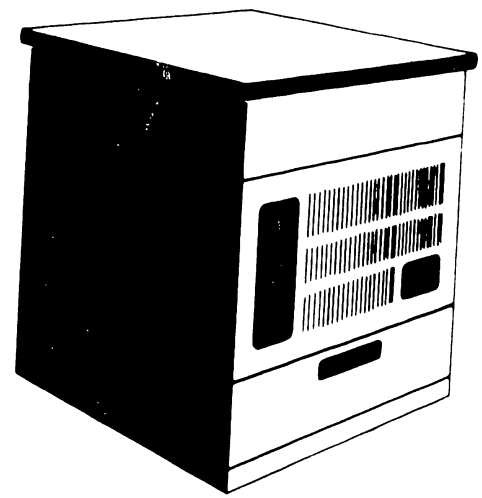
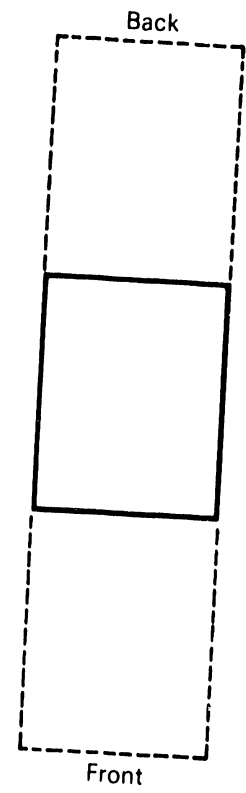

NOTES

OIS SYSTEM 145 CENTRAL PROCESSOR

6545

PRODUCT INFORMATION SHEET

<u>DIMENSIONS</u>	<u>Inches</u>	<u>Centimeters</u>
WIDTH	16	40.6
HEIGHT	13	33.0
DEPTH	21	53.3

<u>NET WEIGHT</u>	<u>Pounds</u>	<u>Kilograms</u>
	50	22.5

<u>SERVICE CLEARANCES</u>	<u>Inches</u>	<u>Centimeters</u>
FRONT	30	76.2
REAR	30	76.2
LEFT	12	42.5
RIGHT	12	42.5
TOP	16	40.6

<u>POWER REQUIREMENTS</u>	<u>115V/60Hz</u>	<u>230V/50Hz</u>
AMPS	3.0	1.5
WATTS		150
DEDICATED CIRCUIT		YES

<u>HEAT OUTPUT (MAX)</u>	<u>Btu/hr</u>	<u>Kcal/hr</u>
	510	128.5

<u>CABLE LENGTH (MAX)</u>	<u>Feet</u>	<u>Meters</u>
POWER DATA	6 2,000	1.8 609.6

NOTES

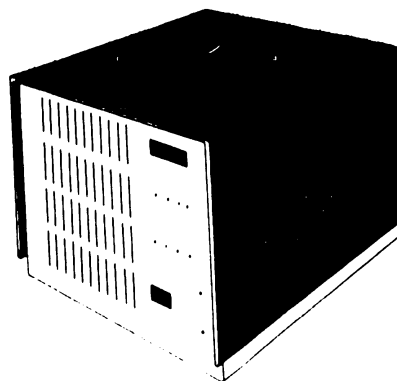
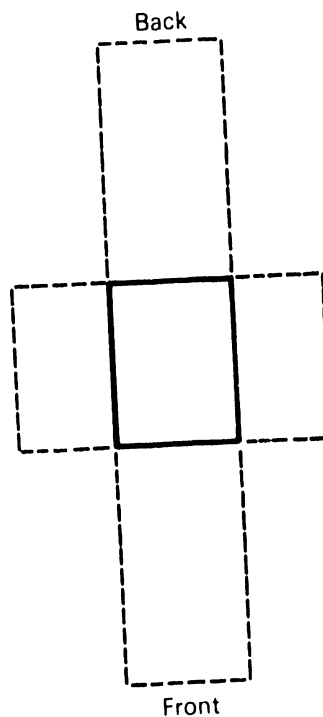

WISE

6550, 6550-1



PRODUCT INFORMATION SHEET

<u>DIMENSIONS</u>	<u>Inches</u>	<u>Centimeters</u>
WIDTH	18.95	48.1
HEIGHT	28.0	71.1
DEPTH	30.7	78.0

<u>NET WEIGHT</u>	<u>Pounds</u>	<u>Kilograms</u>
	130	58.5

<u>SERVICE CLEARANCES</u>	<u>Inches</u>	<u>Centimeters</u>
FRONT	36	91.4
REAR	30	76.2
LEFT	24	61.0
RIGHT	12	30.5
TOP	38	96.5

<u>POWER REQUIREMENTS</u>	<u>115V/60Hz</u>	<u>230V/50Hz</u>
AMPS	7.0	3.5
WATTS		500
DEDICATED CIRCUIT		YES

<u>HEAT OUTPUT (MAX)</u>	<u>Btu/hr</u>	<u>Kcal/hr</u>
	1,050	264.6

<u>CABLE LENGTH (MAX)</u>	<u>Feet</u>	<u>Meters</u>
POWER	8	2.5
DATA	NOTE	

NOTES

10 ft (3.04 m) to CPU or 5 ft (1.52 m) to previous drive.

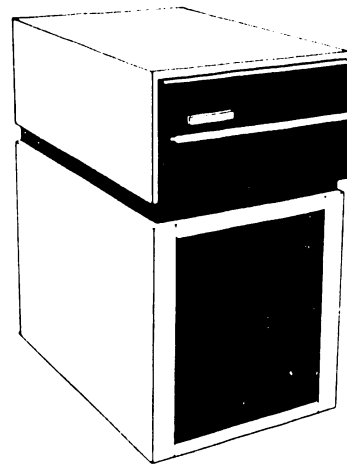
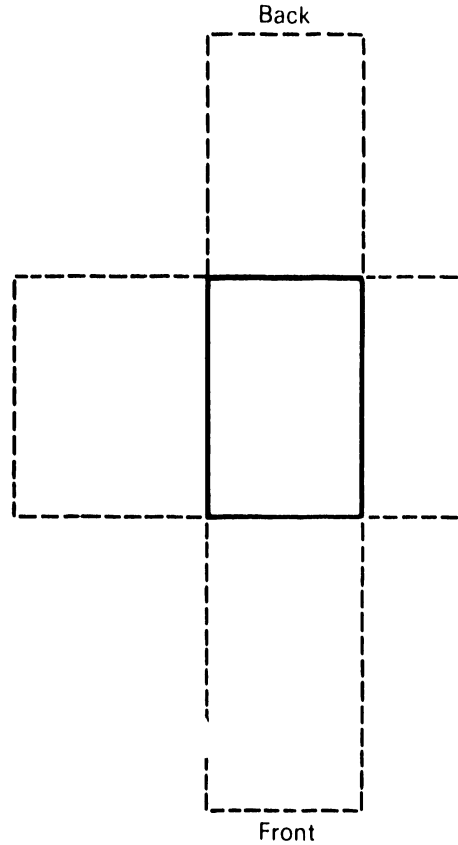

5/10 MB F/R DISK DRIVE

6560

PRODUCT INFORMATION SHEET

<u>DIMENSIONS</u>	<u>Inches</u>	<u>Centimeters</u>
WIDTH	24.0	61.0
HEIGHT	41.0	104.1
DEPTH	36.0	91.4

<u>NET WEIGHT</u>	<u>Pounds</u>	<u>Kilograms</u>
	550	247.5

<u>SERVICE CLEARANCES</u>	<u>Inches</u>	<u>Centimeters</u>
FRONT	36	91.4
REAR	30	76.2
LEFT	12	30.5
RIGHT	12	30.5
TOP	60	152.4

<u>POWER REQUIREMENTS</u>	<u>115V/60Hz</u>	<u>230V/50Hz</u>
AMPS	NOTE 1	NOTE 1
WATTS	1200	
DEDICATED CIRCUIT		YES

<u>HEAT OUTPUT (MAX)</u>	<u>Btu/hr</u>	<u>Kcal/hr</u>
	4200	1058.5

<u>CABLE LENGTH (MAX)</u>	<u>Feet</u>	<u>Meters</u>
POWER	6	1.8
DATA	NOTE 2	NOTE 2

NOTES

1.           20A @ 230V Start-up  
          4A @ 230V Running  
          1A @ 230V Standby
2. 15 ft (4.6 m) to CPU or  
   10 ft (3.04 m) to previous 6565V  
   24 ft (7.3 m) to last drive

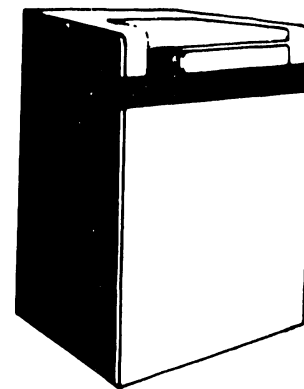
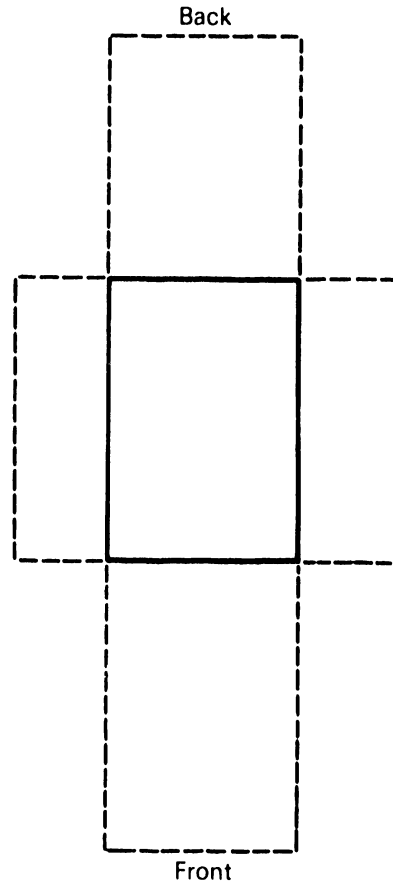

265 MB DISK DRIVE

6565

PRODUCT INFORMATION SHEET

<u>DIMENSIONS</u>	<u>Inches</u>	<u>Centimeters</u>
WIDTH	20.5	52.1
HEIGHT*	36.0	91.4
DEPTH	33.0	83.8

<u>NET WEIGHT</u>	<u>Pounds</u>	<u>Kilograms</u>
	200	90.0

<u>SERVICE CLEARANCES</u>	<u>Inches</u>	<u>Centimeters</u>
FRONT	30	76.2
REAR	30	76.2
LEFT	24	61.0
RIGHT	12	30.5
TOP	39	99.1

<u>POWER REQUIREMENTS</u>	<u>115V/60Hz</u>	<u>230V/50Hz</u>
AMPS		
WATTS		
DEDICATED CIRCUIT		

NOTE 1  
950  
YES

<u>HEAT OUTPUT (MAX)</u>	<u>Btu/hr</u>	<u>Kcal/hr</u>
	3,230	814

<u>CABLE LENGTH (MAX)</u>	<u>Feet</u>	<u>Meters</u>
POWER	8	2.5
DATA	NOTE 2	

NOTES

\*Height with stand  
Height without stand  
12.75 m (32.4 cm)

1. 20A @ 115V (10A @ 230V) Start-up  
8A @ 115V (4A @ 230V) Running
2. 15 ft (4.6 m) to CPU or  
10 ft (3.04 m) to previous 228C  
24 ft (7.3 m) to last drive

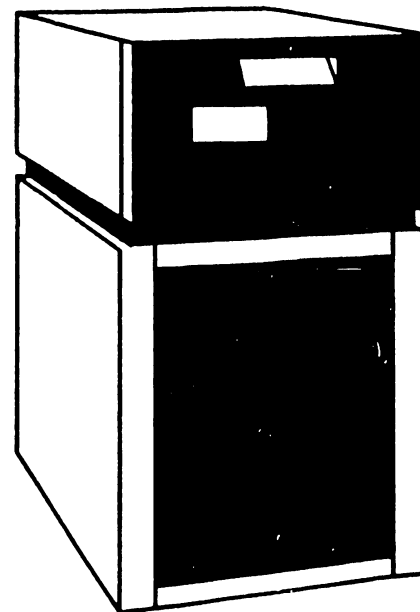
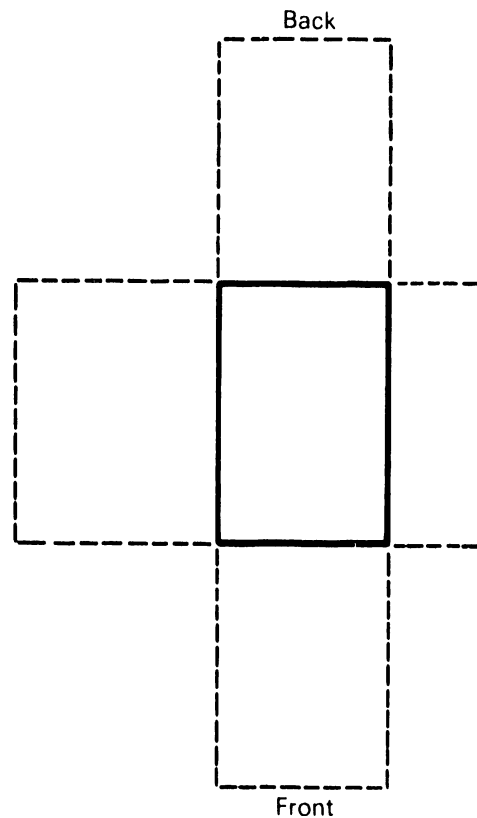

PHOENIX DISK DRIVE

6580

PRODUCT INFORMATION SHEET

<u>DIMENSIONS</u>	<u>Inches</u>	<u>Centimeters</u>
WIDTH	25.0	63.5
HEIGHT	NOTE	
DEPTH	19.5	49.5
<u>NET WEIGHT</u>	<u>Pounds</u>	<u>Kilograms</u>
	70	31.5
<u>SERVICE CLEARANCES</u>	<u>Inches</u>	<u>Centimeters</u>
FRONT	30	76.2
REAR	30	76.2
LEFT	24	61.0
RIGHT	12	30.5
TOP	0	0
<u>POWER REQUIREMENTS</u>	<u>115V/60Hz</u>	<u>230V/50Hz</u>
AMPS	3.0	1.5
WATTS		300
DEDICATED CIRCUIT		NO
<u>HEAT OUTPUT (MAX)</u>	<u>Btu/hr</u>	<u>Kcal/hr</u>
	1,000	252.0
<u>CABLE LENGTH (MAX)</u>	<u>Feet</u>	<u>Meters</u>
POWER	6	1.8
DATA	2,000	609.6

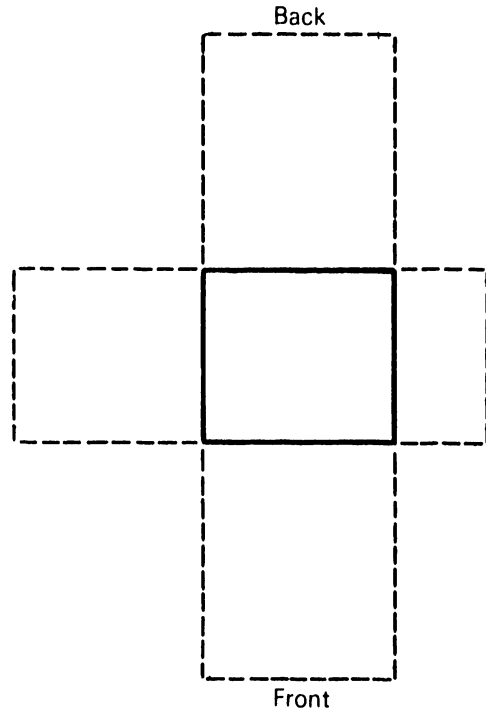

NOTES

Height without forms feeder:  
9 in. (22.9 cm)  
Height with forms feeder:  
12.5 in. (31.8 cm)

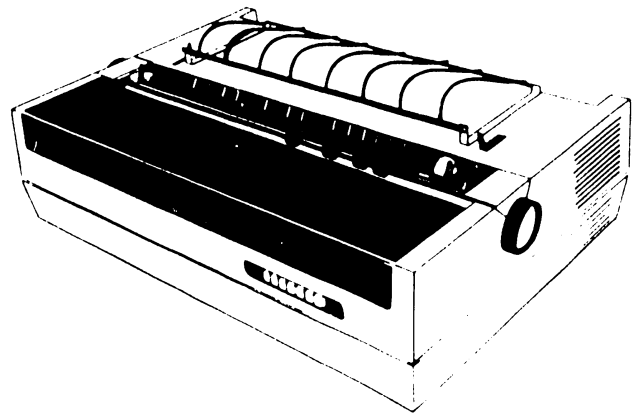

DAISY PRINTER

6581W

PRODUCT INFORMATION SHEET

DIMENSIONS                      Inches                      Centimeters

WIDTH	28.75	73.0
HEIGHT	NOTE	
DEPTH	19.5	49.5

NET WEIGHT                      Pounds                      Kilograms

	70	31.5
--	----	------

SERVICE CLEARANCES      Inches                      Centimeters

FRONT	30	76.2
REAR	36	91.4
LEFT	24	61.0
RIGHT	12	30.5
TOP	0	0

POWER REQUIREMENTS      115V/60Hz                      230V/50Hz

AMPS	3.0 (SB)	2.0 (SB)
WATTS		300
DEDICATED		
CIRCUIT		NO

HEAT OUTPUT (MAX)              Btu/hr                      Kcal/hr

	1,023	257.8
--	-------	-------

CABLE LENGTH (MAX)              Feet                      Meters

POWER	6	1.8
DATA	2,000	609.6

NOTES

Height without forms feeder:  
9.0 in. (22.9 cm)  
Height with forms feeder:  
12.5 in (31.8 cm)

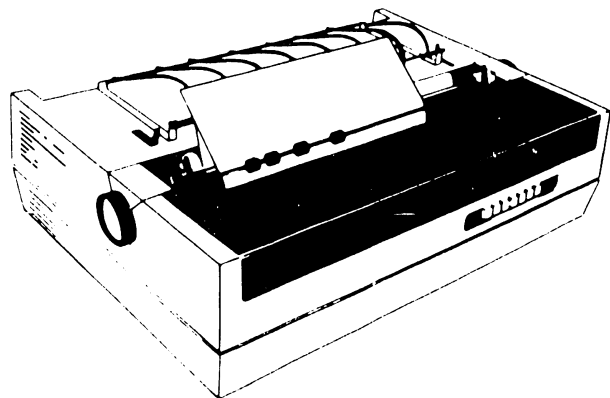
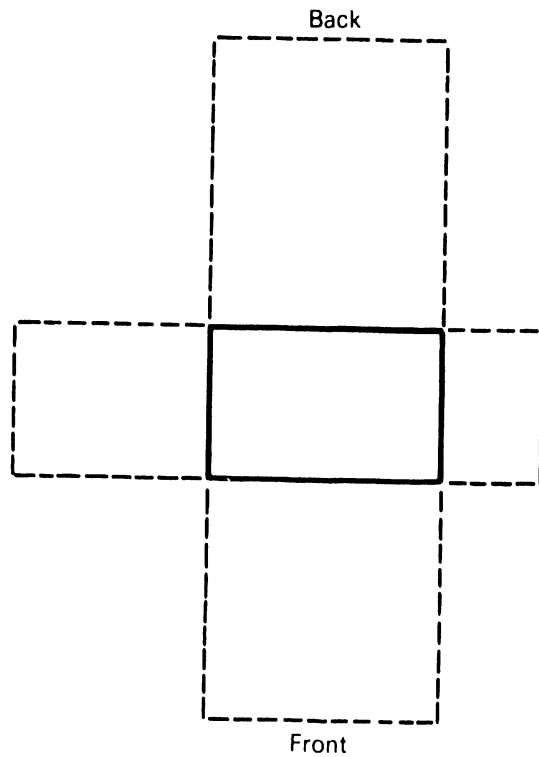

WIDE CARRIAGE DAISY PRINTER

6581WC

PRODUCT INFORMATION SHEET

<u>DIMENSIONS</u>	<u>Inches</u>	<u>Centimeters</u>
WIDTH	32.0	81.3
HEIGHT	28.5	72.4
DEPTH	30.0	76.2

<u>NET WEIGHT</u>	<u>Pounds</u>	<u>Kilograms</u>
	82	36.9

<u>SERVICE CLEARANCES</u>	<u>Inches</u>	<u>Centimeters</u>
FRONT	-	-
REAR	-	-
LEFT	-	-
RIGHT	-	-
TOP	-	-

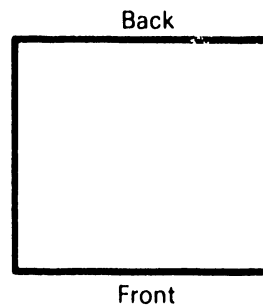

<u>POWER REQUIREMENTS</u>	<u>115V/60Hz</u>	<u>230V/50Hz</u>
AMPS	10	5
WATTS	-	-
DEDICATED CIRCUIT	-	-

<u>HEAT OUTPUT (MAX)</u>	<u>Btu/hr</u>	<u>Kcal/hr</u>
	-	-

<u>CABLE LENGTH (MAX)</u>	<u>Feet</u>	<u>Meters</u>
POWER	14	4.2
DATA	-	-

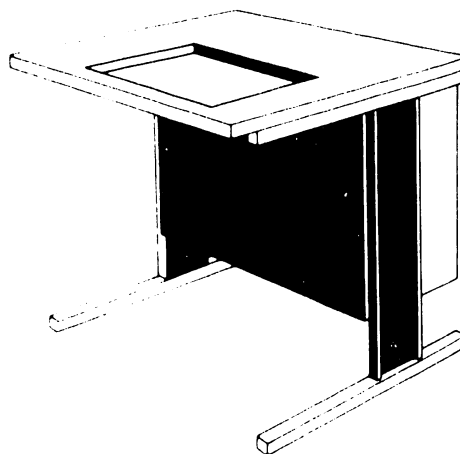

NOTES

TABLE

8001-5

PRODUCT INFORMATION SHEET

<u>DIMENSIONS</u>	<u>Inches</u>	<u>Centimeters</u>
WIDTH	45.0	114.3
HEIGHT	28.5	72.4
DEPTH	30.0	76.2

<u>NET WEIGHT</u>	<u>Pounds</u>	<u>Kilograms</u>
	121	54.5

<u>SERVICE CLEARANCES</u>	<u>Inches</u>	<u>Centimeters</u>
FRONT	-	-
REAR	-	-
LEFT	-	-
RIGHT	-	-
TOP	-	-

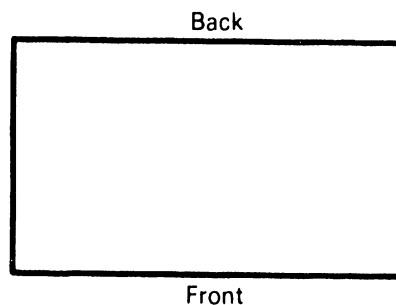

<u>POWER REQUIREMENTS</u>	<u>115V/60Hz</u>	<u>230V/50Hz</u>
AMPS	10	5
WATTS	-	-
DEDICATED CIRCUIT	-	-

<u>HEAT OUTPUT (MAX)</u>	<u>Btu/hr</u>	<u>Kcal/hr</u>
	-	-

<u>CABLE LENGTH (MAX)</u>	<u>Feet</u>	<u>Meters</u>
POWER	14	4.2
DATA	-	-

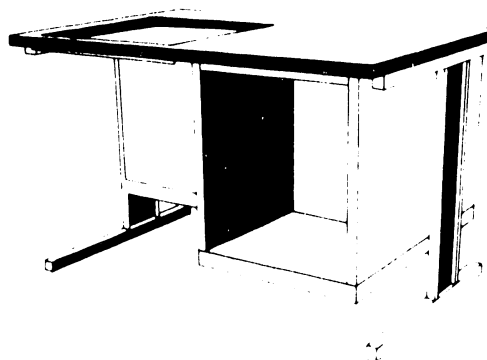

NOTES

8007-5 has the archive drive set-up on the left for left handed users.

2200 TABLE

8002-5

PRODUCT INFORMATION SHEET

<u>DIMENSIONS</u>	<u>Inches</u>	<u>Centimeters</u>
WIDTH	21.25	54.0
HEIGHT	27.25	69.2
DEPTH	36.0	91.4

<u>NET WEIGHT</u>	<u>Pounds</u>	<u>Kilograms</u>
	34	15.3

<u>SERVICE CLEARANCES</u>	<u>Inches</u>	<u>Centimeters</u>
FRONT	-	-
REAR	-	-
LEFT	-	-
RIGHT	-	-
TOP	-	-

<u>POWER REQUIREMENTS</u>	<u>115V/60Hz</u>	<u>230V/50Hz</u>
AMPS	-	-
WATTS	-	-
DEDICATED CIRCUIT	-	-

<u>HEAT OUTPUT (MAX)</u>	<u>Btu/hr</u>	<u>Kcal/hr</u>
	-	-

<u>CABLE LENGTH (MAX)</u>	<u>Feet</u>	<u>Meters</u>
POWER	-	-
DATA	-	-

NOTES

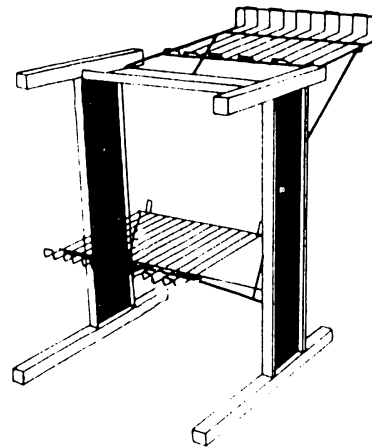

PRINTER STAND

8006-5



PRODUCT INFORMATION SHEET

<u>DIMENSIONS</u>	<u>Inches</u>	<u>Centimeters</u>
WIDTH	45.0	114.3
HEIGHT	28.5	72.4
DEPTH	30.0	76.

<u>NET WEIGHT</u>	<u>Pounds</u>	<u>Kilograms</u>
	121	54.5

<u>SERVICE CLEARANCES</u>	<u>Inches</u>	<u>Centimeters</u>
FRONT	-	-
REAR	-	-
LEFT	-	-
RIGHT	-	-
TOP	-	-

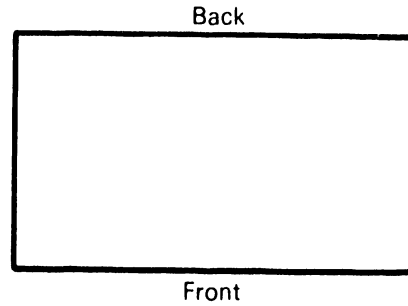

<u>POWER REQUIREMENTS</u>	<u>115V/60Hz</u>	<u>230V/50Hz</u>
AMPS	10	5
WATTS	-	-
DEDICATED CIRCUIT	-	-

<u>HEAT OUTPUT (MAX)</u>	<u>Btu/hr</u>	<u>Kcal/hr</u>
	-	-

<u>CABLE LENGTH (MAX)</u>	<u>Feet</u>	<u>Meters</u>
POWER	14	4.2
DATA	-	-

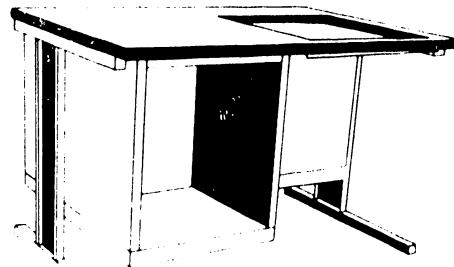

NOTES

TABLE

8007-5

PRODUCT INFORMATION SHEET

<u>DIMENSIONS</u>	<u>Inches</u>	<u>Centimeters</u>
WIDTH	32.0	81.3
HEIGHT	28.5	72.4
DEPTH	30.0	76.2

<u>NET WEIGHT</u>	<u>Pounds</u>	<u>Kilograms</u>
	95	42.8

<u>SERVICE CLEARANCES</u>	<u>Inches</u>	<u>Centimeters</u>
FRONT	-	-
REAR	-	-
LEFT	-	-
RIGHT	-	-
TOP	-	-

<u>POWER REQUIREMENTS</u>	<u>115V/60Hz</u>	<u>230V/50Hz</u>
AMPS	NOTE	NOTE
WATTS	-	-
DEDICATED CIRCUIT		NO

<u>HEAT OUTPUT (MAX)</u>	<u>Btu/hr</u>	<u>Kcal/hr</u>
	-	-

<u>CABLE LENGTH (MAX)</u>	<u>Feet</u>	<u>Meters</u>
POWER DATA	8	2.4

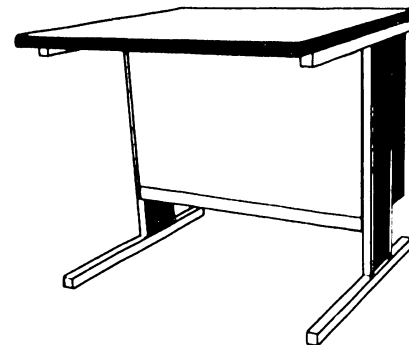
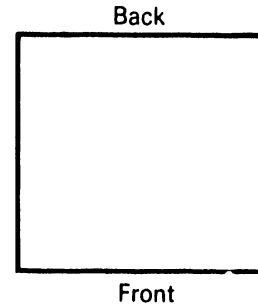

NOTES

The table provides 4 outlets collectively rated at 1400 watts and is fused for 10A at 115VAC or 5A at 230VAC

TABLE

8009-5

PRODUCT INFORMATION SHEET

<u>DIMENSIONS</u>	<u>Inches</u>	<u>Centimeters</u>
WIDTH	NOTE	
HEIGHT	28.5	72.4
DEPTH	30.0	76.2

<u>NET WEIGHT</u>	<u>Pounds</u>	<u>Kilograms</u>
	35	15.8

<u>SERVICE CLEARANCES</u>	<u>Inches</u>	<u>Centimeters</u>
FRONT	-	-
REAR	-	-
LEFT	-	-
RIGHT	-	-
TOP	-	-

<u>POWER REQUIREMENTS</u>	<u>115V/60Hz</u>	<u>230V/50Hz</u>
AMPS	-	-
WATTS	-	-
DEDICATED CIRCUIT	-	-

<u>HEAT OUTPUT (MAX)</u>	<u>Btu/hr</u>	<u>Kcal/hr</u>
	-	-

<u>CABLE LENGTH (MAX)</u>	<u>Feet</u>	<u>Meters</u>
POWER	-	-
DATA	-	-

NOTES

Width (Front) 7 in. (17.8 cm)  
 Width (Rear) 30 in. (76.2 cm)

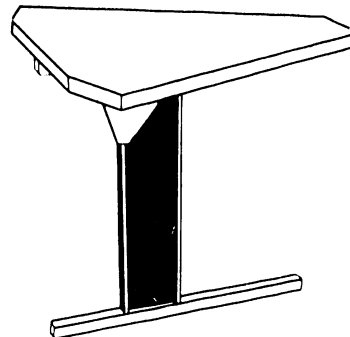
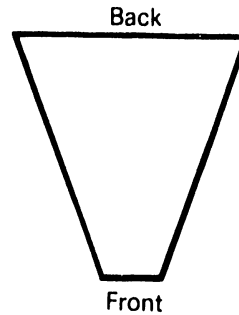

TABLE WEDGE

8017-5

PRODUCT INFORMATION SHEET

<u>DIMENSIONS</u>	<u>Inches</u>	<u>Centimeters</u>
WIDTH	14	35.6
HEIGHT	NOTE	
DEPTH	15	38.1

<u>NET WEIGHT</u>	<u>Pounds</u>	<u>Kilograms</u>
	-	-

<u>SERVICE CLEARANCES</u>	<u>Inches</u>	<u>Centimeters</u>
FRONT	-	-
REAR	-	-
LEFT	-	-
RIGHT	-	-
TOP	-	-

<u>POWER REQUIREMENTS</u>	<u>115V/60Hz</u>	<u>230V/50Hz</u>
AMPS	-	-
WATTS	-	-
DEDICATED CIRCUIT	-	-

<u>HEAT OUTPUT (MAX)</u>	<u>Btu/hr</u>	<u>Kcal/hr</u>
	-	-

<u>CABLE LENGTH (MAX)</u>	<u>Feet</u>	<u>Meters</u>
POWER	-	-
DATA	-	-

NOTES

to be used with:  
 8002-5 (FS-2)  
 8007-5 (FS-26)  
 MT-1

Height: Drawer 1  
 6.125 m (15.6 cm)  
 Height: Drawer 2  
 12.25 m (31.1 cm)

FILE DRAWER ASSEMBLY OPTION

8056

PRODUCT INFORMATION SHEET

<u>DIMENSIONS</u>	<u>Inches</u>	<u>Centimeters</u>
WIDTH	35.5	90.2
HEIGHT	41.0	104.1
DEPTH	31.5	80.0

<u>NET WEIGHT</u>	<u>Pounds</u>	<u>Kilograms</u>
	400	180

<u>SERVICE CLEARANCES</u>	<u>Inches</u>	<u>Centimeters</u>
FRONT	36	91.4
REAR	30	76.2
LEFT	0	0
RIGHT	0	0
TOP	48	120.0

<u>POWER REQUIREMENTS</u>	<u>115V/60Hz</u>	<u>230V/50Hz</u>
AMPS	12	6
WATTS		1,380
DEDICATED CIRCUIT		YES

<u>HEAT OUTPUT (MAX)</u>	<u>Btu/hr</u>	<u>Kcal/hr</u>
	6,600	1,663.3

<u>CABLE LENGTH (MAX)</u>	<u>Feet</u>	<u>Meters</u>
POWER	9	2.9
DATA	-	-

NOTES

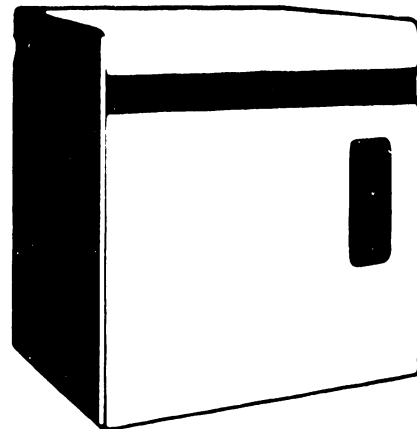
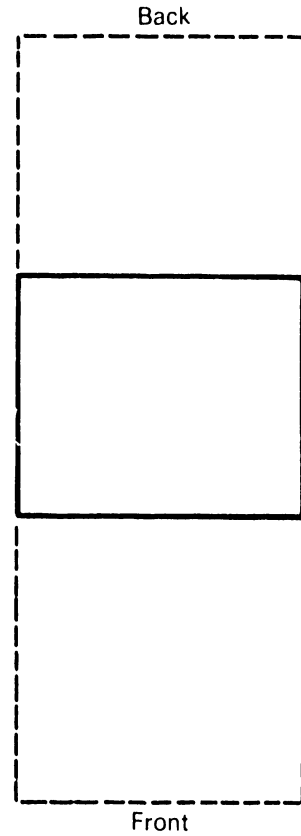

VS-50 CENTRAL PROCESSOR

VS-50

PRODUCT INFORMATION SHEET

<u>DIMENSIONS</u>	<u>Inches</u>	<u>Centimeters</u>
WIDTH	35.5	90.2
HEIGHT	41.0	104.1
DEPTH	31.5	80.0
<u>NET WEIGHT</u>	<u>Pounds</u>	<u>Kilograms</u>
	353	158.8
<u>SERVICE CLEARANCES</u>	<u>Inches</u>	<u>Centimeters</u>
FRONT	36	91.4
REAR	30	76.2
LEFT	0	0
RIGHT	0	0
TOP	48	120.0
<u>POWER REQUIREMENTS</u>	<u>115V/60Hz</u>	<u>230V/50Hz</u>
AMPS	12	6
WATTS		1,380
DEDICATED CIRCUIT		YES
<u>HEAT OUTPUT (MAX)</u>	<u>Btu/hr</u>	<u>Kcal/hr</u>
	6,000	1,512.1
<u>CABLE LENGTH (MAX)</u>	<u>Feet</u>	<u>Meters</u>
POWER DATA	9	2.9

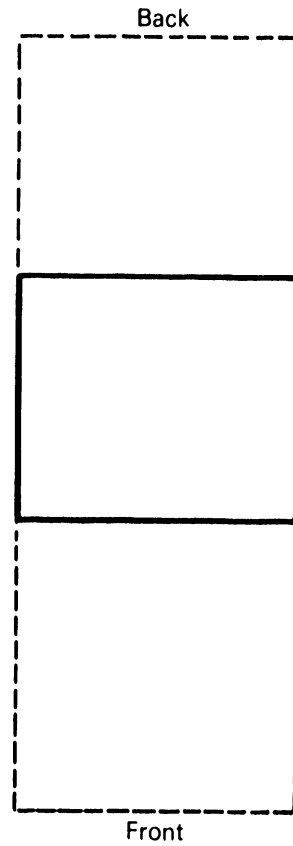

NOTES

Dedicated circuit with 30A wall breaker

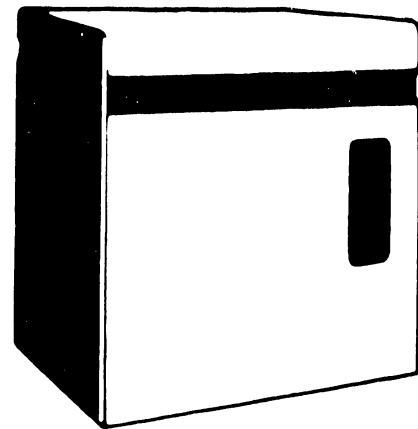

VS CENTRAL PROCESSOR

VS 60

PRODUCT INFORMATION SHEET

<u>DIMENSIONS</u>	<u>Inches</u>	<u>Centimeters</u>
WIDTH	48.0	122.0
HEIGHT	41.0	104.1
DEPTH	32.0	81.0

<u>NET WEIGHT</u>	<u>Pounds</u>	<u>Kilograms</u>
	750	337.5

<u>SERVICE CLEARANCES</u>	<u>Inches</u>	<u>Centimeters</u>
FRONT	36	91.4
REAR	30	76.2
LEFT	0	0
RIGHT	0	0
TOP	78	198

<u>POWER REQUIREMENTS</u>	<u>115V/60Hz</u>	<u>230V/50Hz/60Hz</u>	
AMPS	-	17.0	NOTE
WATTS	-	2,027	
DEDICATED CIRCUIT	-	YES (NOTE)	

<u>HEAT OUTPUT (MAX)</u>	<u>Btu/hr</u>	<u>Kcal/hr</u>
	8,000	2,000

<u>CABLE LENGTH (MAX)</u>	<u>Feet</u>	<u>Meters</u>
POWER	9	2.9
DATA	-	-

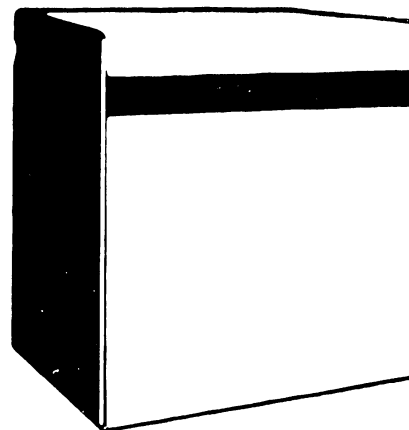
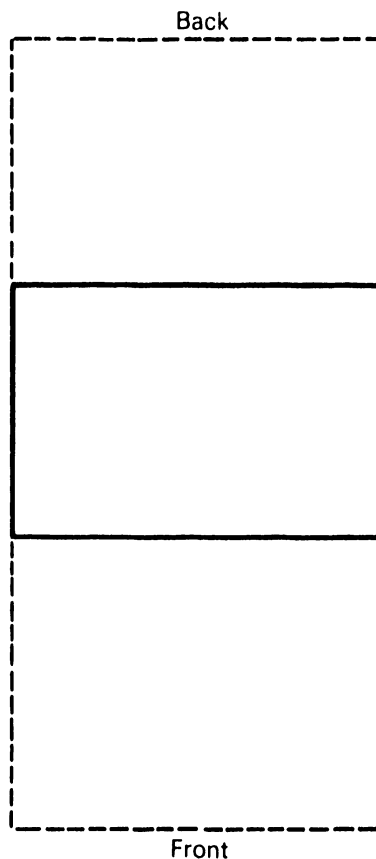

NOTES

Dedicated circuit with 30A wall breaker  
 208V 2 of 3 Phases 60Hz  
 230V Split Phase 60Hz  
 NEMA L14-30 Receptacle

VS-100 CENTRAL PROCESSOR

VS-100

PRODUCT INFORMATION SHEET

<u>DIMENSIONS</u>	<u>Inches</u>	<u>Centimeters</u>
WIDTH	16.5	42.0
HEIGHT	13.25	33.6
DEPTH	22.0	55.9

<u>NET WEIGHT</u>	<u>Pounds</u>	<u>Kilograms</u>
	42	19

<u>SERVICE CLEARANCES</u>	<u>Inches</u>	<u>Centimeters</u>
FRONT	30	76.2
REAR	12	30.5
LEFT	12	30.5
RIGHT	12	30.5
TOP	14	35.6

<u>POWER REQUIREMENTS</u>	<u>115V/60Hz</u>	<u>230V/50Hz</u>
AMPS	3.0	1.5
WATTS		250
DEDICATED CIRCUIT		NO

<u>HEAT OUTPUT (MAX)</u>	<u>Btu/hr</u>	<u>Kcal/hr</u>
	855	215.5

<u>CABLE LENGTH (MAX)</u>	<u>Feet</u>	<u>Meters</u>
POWER	7	2.1
DATA	2,000	609.6

NOTES

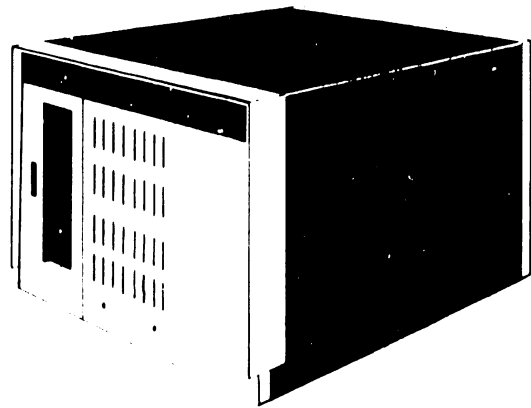
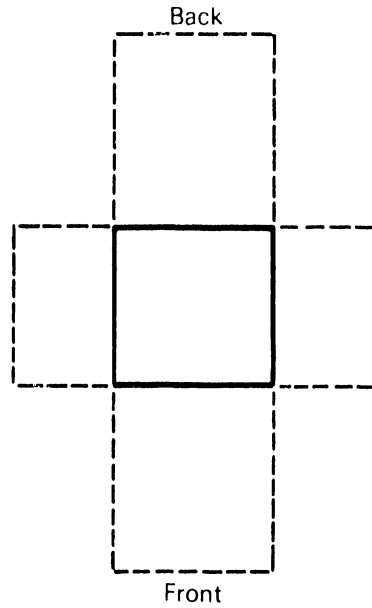

ARCHIVING WORKSTATION MASTER

AWS-1



PRODUCT INFORMATION SHEET

DIMENSIONS                      Inches                      Centimeters

WIDTH	NOTE	
HEIGHT	6.75	17.1
DEPTH	8.4	21.4

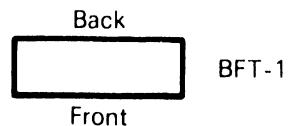

NET WEIGHT                      Pounds                      Kilograms

NOTE

SERVICE CLEARANCES   Inches                      Centimeters

FRONT	-	-
REAR	-	-
LEFT	-	-
RIGHT	-	-
TOP	-	-

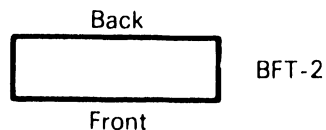

POWER REQUIREMENTS   115V/60Hz                      230V/50Hz

AMPS	-	-
WATTS	-	-
DEDICATED CIRCUIT	-	-

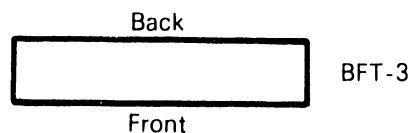

HEAT OUTPUT (MAX)   Btu/hr                      Kcal/hr

-                      -

CABLE LENGTH (MAX)   Feet                      Meters

POWER	-	-
DATA	-	-

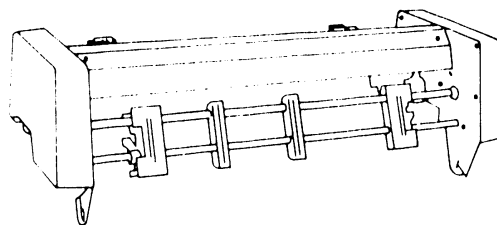

NOTES

	WIDTH	WEIGHT
BFT-1	21.5 in. (54.6 cm)	6 lb. (2.7 kg)
BFT-2	26.4 in. (67.1 cm)	6.5 lb. (2.93 kg)
BFT-3	37.4 in. (95.0 cm)	9 lb. (4.05 kg)

BIDIRECTIONAL FORMS TRACTOR

BFT-1, BFT-2, BFT-3

PRODUCT INFORMATION SHEET

<u>DIMENSIONS</u>	<u>Inches</u>	<u>Centimeters</u>
WIDTH	NOTE	
HEIGHT	28.5	72.4
DEPTH	30.0	76.2

<u>NET WEIGHT</u>	<u>Pounds</u>	<u>Kilograms</u>
	35	15.8

<u>SERVICE CLEARANCES</u>	<u>Inches</u>	<u>Centimeters</u>
FRONT	-	-
REAR	-	-
LEFT	-	-
RIGHT	-	-
TOP	-	-

<u>POWER REQUIREMENTS</u>	<u>115V/60Hz</u>	<u>230V/50Hz</u>
AMPS	-	-
WATTS	-	-
DEDICATED CIRCUIT	-	-

<u>HEAT OUTPUT (MAX)</u>	<u>Btu/hr</u>	<u>Kcal/hr</u>
	-	-

<u>CABLE LENGTH (MAX)</u>	<u>Feet</u>	<u>Meters</u>
POWER	-	-
DATA	-	-

NOTES

Width (Front) 7 in. (17.8 cm)  
 Width (Rear) 30 in. (76.2 cm)

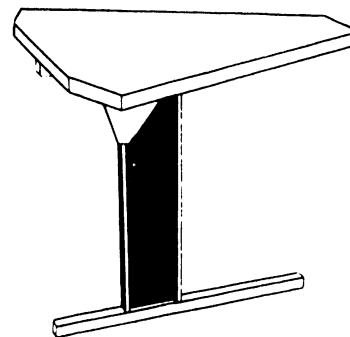
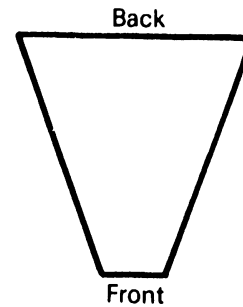

CONSOLE EXTENSION

CET-1

PRODUCT INFORMATION SHEET

<u>DIMENSIONS</u>	<u>Inches</u>	<u>Centimeters</u>
WIDTH	23.5	59.7
HEIGHT	17.0	43.1
DEPTH	14.0	35.6

<u>NET WEIGHT</u>	<u>Pounds</u>	<u>Kilograms</u>
	28.5	12.9

<u>SERVICE CLEARANCES</u>	<u>Inches</u>	<u>Centimeters</u>
FRONT	-	-
REAR	-	-
LEFT	-	-
RIGHT	-	-
TOP	-	-

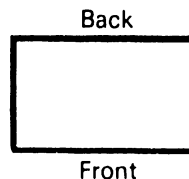

<u>POWER REQUIREMENTS</u>	<u>115V/60Hz</u>	<u>230V/50Hz</u>
AMPS	.6	.6
WATTS		50
DEDICATED CIRCUIT		-

<u>HEAT OUTPUT (MAX)</u>	<u>Btu/hr</u>	<u>Kcal/hr</u>
	-	-

<u>CABLE LENGTH (MAX)</u>	<u>Feet</u>	<u>Meters</u>
POWER	-	-
DATA	-	-

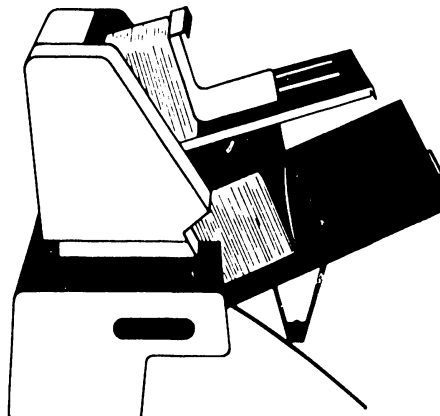

NOTES

ENVELOPE FEEDER

EF-1, EF-2, EF-3

PRODUCT INFORMATION SHEET

<u>DIMENSIONS</u>	<u>Inches</u>	<u>Centimeters</u>
WIDTH	24.0	61.0
HEIGHT	28.5	72.4
DEPTH	30.0	76.2

<u>NET WEIGHT</u>	<u>Pounds</u>	<u>Kilograms</u>
	150	67.5

<u>SERVICE CLEARANCES</u>	<u>Inches</u>	<u>Centimeters</u>
FRONT	-	-
REAR	-	-
LEFT	-	-
RIGHT	-	-
TOP	-	-

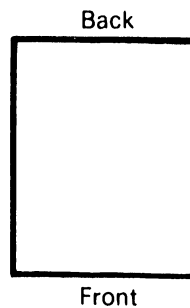

<u>POWER REQUIREMENTS</u>	<u>115V/60Hz</u>	<u>230V/50Hz</u>
AMPS	-	-
WATTS	-	-
DEDICATED CIRCUIT	-	-

<u>HEAT OUTPUT (MAX)</u>	<u>Btu/hr</u>	<u>Kcal/hr</u>
	-	-

<u>CABLE LENGTH (MAX)</u>	<u>Feet</u>	<u>Meters</u>
POWER	-	-
DATA	-	-

NOTES

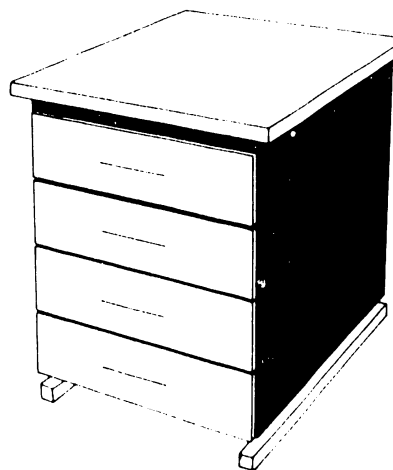

FST FILE SUPPLY TABLE

FST-1

PRODUCT INFORMATION SHEET

<u>DIMENSIONS</u>	<u>Inches</u>	<u>Centimeters</u>
WIDTH	58.0	147.3
HEIGHT	57.5	146.1
DEPTH	23.0	58.4

<u>NET WEIGHT</u>	<u>Pounds</u>	<u>Kilograms</u>
	425	191.3

<u>SERVICE CLEARANCES</u>	<u>Inches</u>	<u>Centimeters</u>
FRONT	24	61.0
REAR	30	76.2
LEFT	30	76.2
RIGHT	30	76.2
TOP	0	0

POWER REQUIREMENTS 115V/60Hz

AMPS	NOTE 1
WATTS	NOTE 2
DEDICATED CIRCUIT	YES

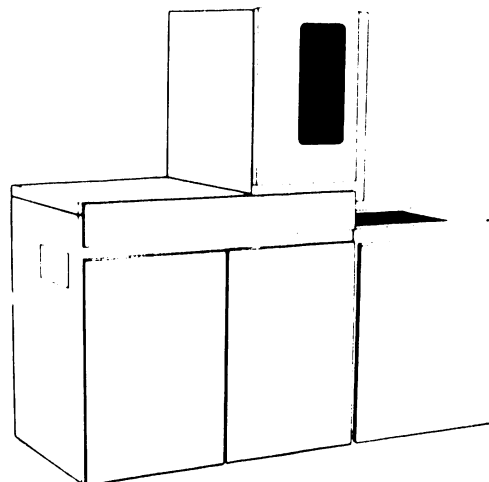

<u>HEAT OUTPUT (MAX)</u>	<u>Btu/hr</u>	<u>Kcal/hr</u>
	5,800	1,461.7
<u>CABLE LENGTH (MAX)</u>	<u>Feet</u>	<u>Meters</u>
POWER DATA	6	1.8
	NOTE 3	NOTE 3

NOTES

1. One 20A line
2. 2300 Watts and 1150 Watts
3. IF41D, 2000 ft (609.6 m)

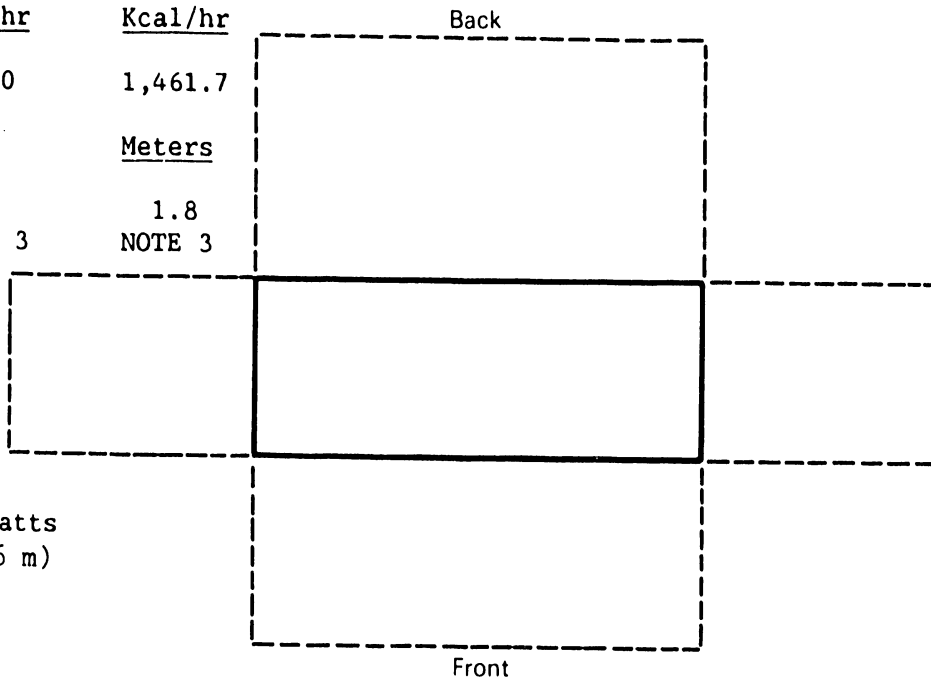

IMAGE PRINTER

IP41

**PRODUCT INFORMATION SHEET**

<u>DIMENSIONS</u>	<u>Inches</u>	<u>Centimeters</u>
WIDTH	15.0	38.1
HEIGHT	9.3	23.5
DEPTH	22.0	55.9

<u>NET WEIGHT</u>	<u>Pounds</u>	<u>Kilograms</u>
	47	21.2

<u>SERVICE CLEARANCES</u>	<u>Inches</u>	<u>Centimeters</u>
FRONT	0	0
REAR	0	0
LEFT	15	38.1
RIGHT	0	0
TOP	12	30.5

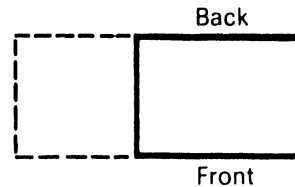

<u>POWER REQUIREMENTS</u>	<u>115V/60Hz</u>	<u>230V/50Hz</u>
AMPS	5	3.0
WATTS		575
DEDICATED CIRCUIT		NO

<u>HEAT OUTPUT (MAX)</u>	<u>Btu/hr</u>	<u>Kcal/hr</u>
	1,965	495.2

<u>CABLE LENGTH (MAX)</u>	<u>Feet</u>	<u>Meters</u>
POWER	6	1.8
DATA	2,000	609.6

NOTES

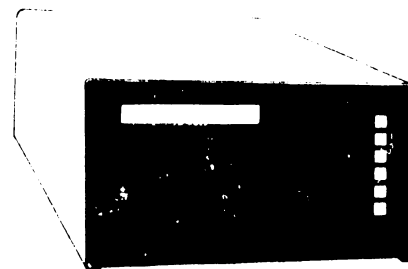

MAG CARD READER

MCR-1

PRODUCT INFORMATION SHEET

<u>DIMENSIONS</u>	<u>Inches</u>	<u>Centimeters</u>
WIDTH	45.0	114.3
HEIGHT	28.5	72.4
DEPTH	30.0	76.2

<u>NET WEIGHT</u>	<u>Pounds</u>	<u>Kilograms</u>
	155	69.8

<u>SERVICE CLEARANCES</u>	<u>Inches</u>	<u>Centimeters</u>
FRONT	-	-
REAR	-	-
LEFT	-	-
RIGHT	-	-
TOP	-	-

<u>POWER REQUIREMENTS</u>	<u>115V/60Hz</u>	<u>230V/50Hz</u>
AMPS		
WATTS	NOTE	
DEDICATED	1,400	
CIRCUIT	-	

<u>HEAT OUTPUT (MAX)</u>	<u>Btu/hr</u>	<u>Kcal/hr</u>
	-	-

<u>CABLE LENGTH (MAX)</u>	<u>Feet</u>	<u>Meters</u>
POWER	8	2.4
DATA	-	-

NOTES

The table provides 4 outlets collectively rated at 1400 W fused for 10A at 115VAC or 5 A at 230VAC.

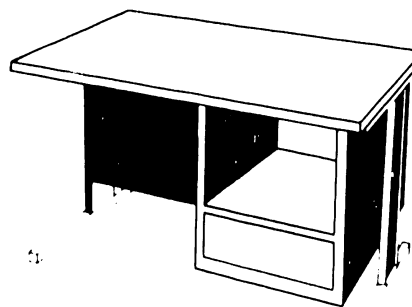
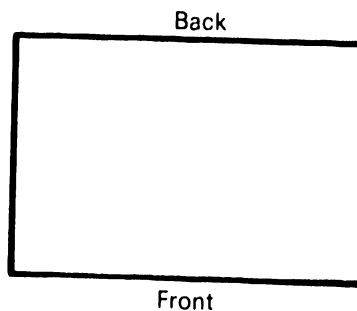

TABLE

MT-1

PRODUCT INFORMATION SHEET

<u>DIMENSIONS</u>	<u>Inches</u>	<u>Centimeters</u>
WIDTH	9.2	23.4
HEIGHT	7.8	19.8
DEPTH	19.3	49.0

<u>NET WEIGHT</u>	<u>Pounds</u>	<u>Kilograms</u>
	18	8.1

<u>SERVICE CLEARANCES</u>	<u>Inches</u>	<u>Centimeters</u>
FRONT	0	0
REAR	6	15.2
LEFT	12	30.5
RIGHT	12	30.5
TOP	15	38.1

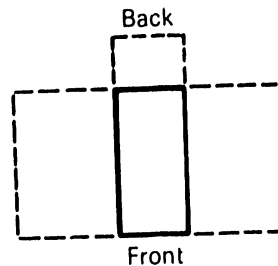

<u>POWER REQUIREMENTS</u>	<u>115V/60Hz</u>	<u>230V/50Hz</u>
AMPS	3.0	1.5
WATTS		100
DEDICATED CIRCUIT		NO

<u>HEAT OUTPUT (MAX)</u>	<u>Btu/hr</u>	<u>Kcal/hr</u>
	350	88.2

<u>CABLE LENGTH (MAX)</u>	<u>Feet</u>	<u>Meters</u>
POWER	6	1.8
DATA	NOTE	

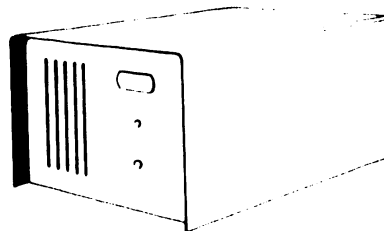

NOTES

12 ft (3.6 m) cable from OCR-1 controller to modem.  
2000 ft (609.6 m) to system master

OCR INTERFACE

OCR-1



PRODUCT INFORMATION SHEET

<u>DIMENSIONS</u>	<u>Inches</u>	<u>Centimeters</u>
WIDTH	19.75	50.2
HEIGHT	18.75	47.6
DEPTH	20.5	52.0

<u>NET WEIGHT</u>	<u>Pounds</u>	<u>Kilograms</u>
	57	25.7

<u>SERVICE CLEARANCES</u>	<u>Inches</u>	<u>Centimeters</u>
FRONT	36	90.0
REAR	0	0
LEFT	12	30.5
RIGHT	12	30.5
TOP	24	61.0

<u>POWER REQUIREMENTS</u>	<u>115V/60Hz</u>	<u>230V/50Hz</u>
AMPS	3.0	1.5
WATTS		260
DEDICATED CIRCUIT		NO

<u>HEAT OUTPUT (MAX)</u>	<u>Btu/hr</u>	<u>Kcal/hr</u>
	888	223.8

<u>CABLE LENGTH (MAX)</u>	<u>Feet</u>	<u>Meters</u>
POWER	8	2.4
DATA	-	-

NOTES

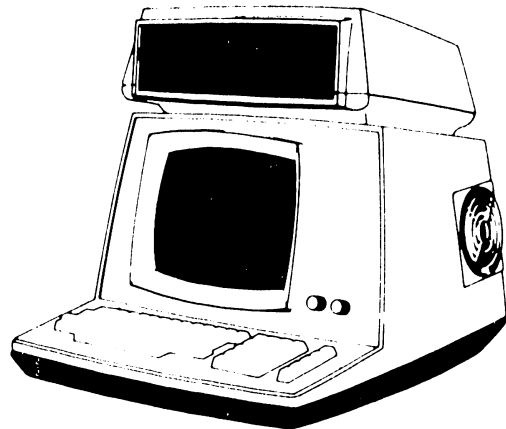
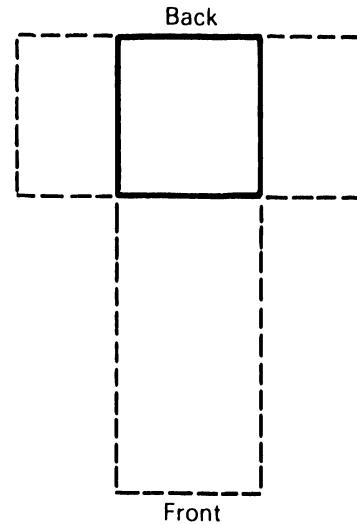

DESK TOP COMPUTER

PCS-II

PRODUCT INFORMATION SHEET

<u>DIMENSIONS</u>	<u>Inches</u>	<u>Centimeters</u>
WIDTH	13.4	34.1
HEIGHT	9.7	24.8
DEPTH	15.6	39.7

<u>NET WEIGHT</u>	<u>Pounds</u>	<u>Kilograms</u>
	23.5	10.6

<u>SERVICE CLEARANCES</u>	<u>Inches</u>	<u>Centimeters</u>
FRONT	12	0
REAR	12	15.2
LEFT	6	30.5
RIGHT	6	30.5
TOP	12	38.1

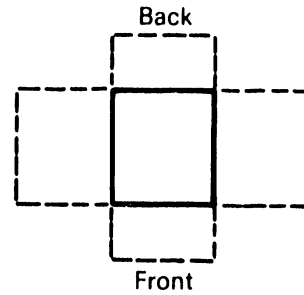

<u>POWER REQUIREMENTS</u>	<u>115V/60Hz</u>	<u>230V/50Hz</u>
AMPS	4.0	2.0
WATTS		300
DEDICATED CIRCUIT		NO

<u>HEAT OUTPUT (MAX)</u>	<u>Btu/hr</u>	<u>Kcal/hr</u>
	1,020	255

<u>CABLE LENGTH (MAX)</u>	<u>Feet</u>	<u>Meters</u>
POWER	8	2.4
DATA	12	3.7

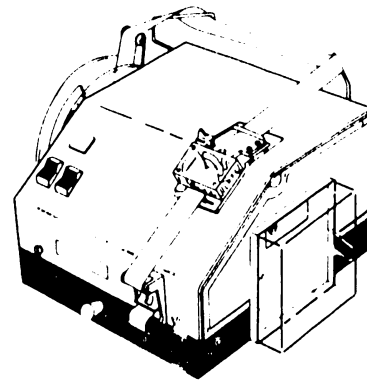

NOTES

Refer to OCR-1 for Interface Translator Specs.

PHOTOCOMPOSITION OPTION

PIO

**PRODUCT INFORMATION SHEET**

<u>DIMENSIONS</u>	<u>Inches</u>	<u>Centimeters</u>
WIDTH	26.0	66.0
HEIGHT	28.5	72.4
DEPTH	30.0	76.2

<u>NET WEIGHT</u>	<u>Pounds</u>	<u>Kilograms</u>
	59	26.6

<u>SERVICE CLEARANCES</u>	<u>Inches</u>	<u>Centimeters</u>
FRONT	-	-
REAR	-	-
LEFT	-	-
RIGHT	-	-
TOP	-	-

<u>POWER REQUIREMENTS</u>	<u>115V/60Hz</u>	<u>230V/50Hz</u>
AMPS	-	-
WATTS	-	-
DEDICATED CIRCUIT	-	-

<u>HEAT OUTPUT (MAX)</u>	<u>Btu/hr</u>	<u>Kcal/hr</u>
	-	-

<u>CABLE LENGTH (MAX)</u>	<u>Feet</u>	<u>Meters</u>
POWER	-	-
DATA	-	-

NOTES

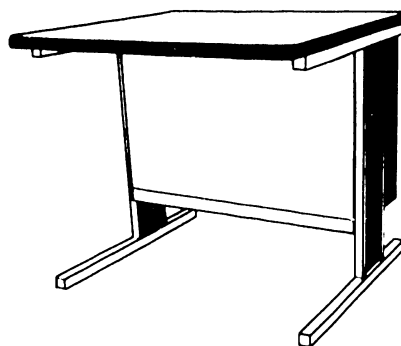
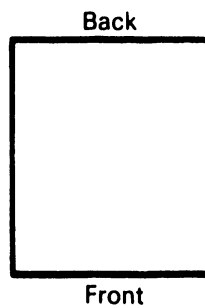

TABLE

PT-1

PRODUCT INFORMATION SHEET

<u>DIMENSIONS</u>	<u>Inches</u>	<u>Centimeters</u>
WIDTH	27.5	69.9
HEIGHT	17.75	45.1
DEPTH	28.75	73.0

<u>NET WEIGHT</u>	<u>Pounds</u>	<u>Kilograms</u>
	31	14.0

<u>SERVICE CLEARANCES</u>	<u>Inches</u>	<u>Centimeters</u>
FRONT	-	-
REAR	-	-
LEFT	-	-
RIGHT	-	-
TOP	-	-

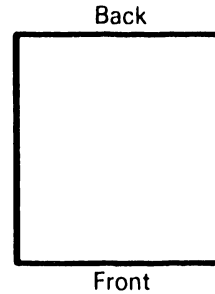

<u>POWER REQUIREMENTS</u>	<u>115V/60Hz</u>	<u>230V/50Hz</u>
AMPS	6	3
WATTS		700
DEDICATED CIRCUIT	-	NO -

<u>HEAT OUTPUT (MAX)</u>	<u>Btu/hr</u>	<u>Kcal/hr</u>
	-	-

<u>CABLE LENGTH (MAX)</u>	<u>Feet</u>	<u>Meters</u>
POWER	6	1.8
DATA	-	-

NOTES

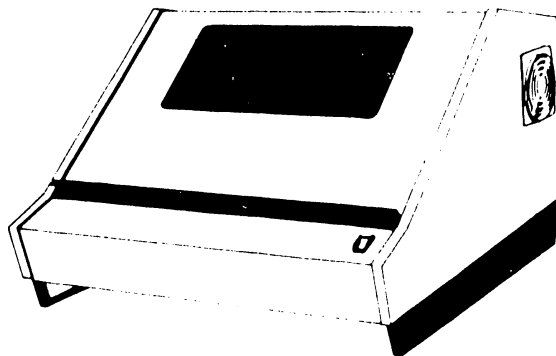

SILENCER COVER

SH-1

PRODUCT INFORMATION SHEET

DIMENSIONS                      Inches                      Centimeters

WIDTH	NOTE 1	
HEIGHT	14.0	35.6
DEPTH	12.0	30.5

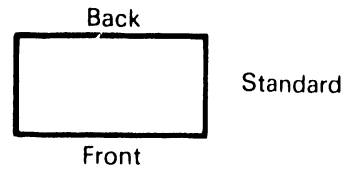

NET WEIGHT                      Pounds                      Kilograms

	15	6.8
--	----	-----

SERVICE CLEARANCES      Inches                      Centimeters

FRONT	-	-
REAR	-	-
LEFT	-	-
RIGHT	-	-
TOP	16	40.6

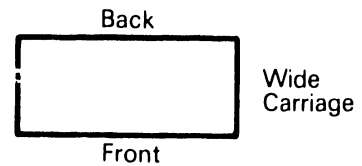

POWER REQUIREMENTS      115V/60Hz                  230V/50Hz

AMPS	-	-
WATTS	-	-
DEDICATED CIRCUIT	-	-

HEAT OUTPUT (MAX)          Btu/hr                      Kcal/hr

	-	-
--	---	---

CABLE LENGTH (MAX)      Feet                      Meters

POWER	-	-
DATA	-	-

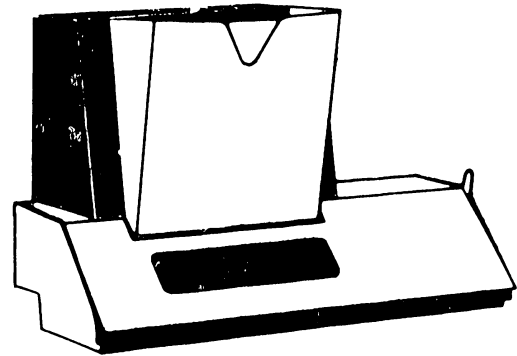

NOTES

Width:  
 Standard Printer - 23.5 in. (59.7 cm)  
 Wide Carriage - 28.5 in. (72.4 cm)

TWIN SHEET FEEDER

TSF-01, -03, -05, -06, -20,  
 -21, -22, -23, -31, -33, -41, -43

PRODUCT INFORMATION SHEET

<u>DIMENSIONS</u>	<u>Inches</u>	<u>Centimeters</u>
WIDTH	32.0	81.3
HEIGHT	28.5	72.4
DEPTH	30.0	76.2

<u>NET WEIGHT</u>	<u>Pounds</u>	<u>Kilograms</u>
	95	42.8

<u>SERVICE CLEARANCES</u>	<u>Inches</u>	<u>Centimeters</u>
FRONT	-	-
REAR	-	-
LEFT	-	-
RIGHT	-	-
TOP	-	-

<u>POWER REQUIREMENTS</u>	<u>115V/60Hz</u>	<u>230V/50Hz</u>
AMPS	NOTE	NOTE
WATTS	-	-
DEDICATED CIRCUIT	NO	NO

<u>HEAT OUTPUT (MAX)</u>	<u>Btu/hr</u>	<u>Kcal/hr</u>
	-	-

<u>CABLE LENGTH (MAX)</u>	<u>Feet</u>	<u>Meters</u>
POWER	8	2.4
DATA	-	-

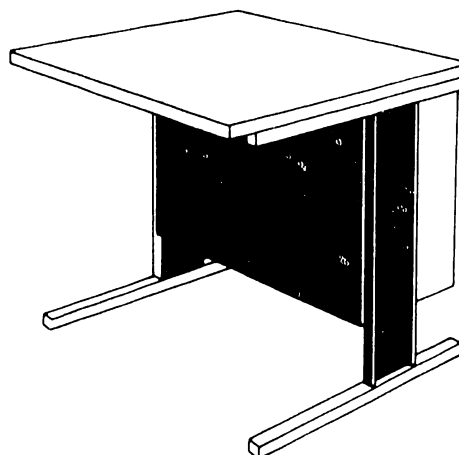
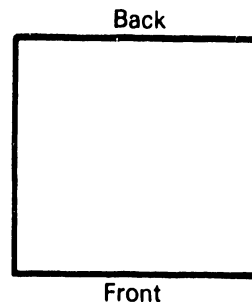

NOTES

The table provides 4 outlets collectively rated at 1400 Watts. it is fused for IDA at 115VAC or 5A at 230VAC

TABLE

WST-1

**END**