

WANG

BAND PRINTER NOTES

Models:

2273,	2273-2
2273V,	5573
2273-1,	5574
2273V-1	

COMPANY PROPRIETARY STATEMENT

This document is the property of Wang Laboratories, Inc. All information contained herein is considered Company Proprietary, and its use is restricted solely to assisting you in servicing Wang products. Neither this document nor its contents may be disclosed, copied, revealed, or used in whole or in part for any other purpose without the prior written permission of Wang Laboratories, Inc. This document must be returned upon request of Wang Laboratories, Inc.

**Customer Engineering
Product Maintenance Manual**

741-0438

PREFACE

This document is the Standard Maintenance (STD) Manual for the Band Printer. It is organized in accordance with the approved STD outline established at the Field/Home Office Publications meetings conducted on September 14th and 15th, 1982. The scope of this manual reflects the type of maintenance philosophy selected for this product (swap unit, printed circuit assembly, chip level or any combination thereof).

The purpose of this manual is to provide the Wang-trained Customer Engineer (CE) with instructions to operate, troubleshoot and repair the Band Printer. It will be updated on a regular schedule.

Third Edition (December 1984)

This reprint is the new converted part number for 729-0438-A and 729-0438-A1. The material in this document may only be used for the purpose stated in the Preface. Updates and/or changes to this document will be published as Publications Update Bulletins (PUB's) or subsequent editions.

© Copyright WANG Labs., Inc. 1980, 1981, 1983, 1984

PSN

IIIIC10-1

PRODUCT SERVICE NOTICE

DATE : 1/15/80

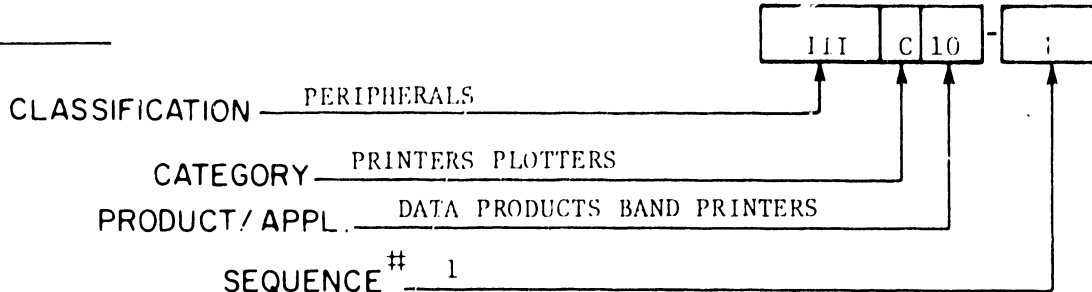

TITLE :

2273/2273V BAND PRINTER: CIRCUIT BOARD INFORMATION

This PSN documents information that should be considered when replacing circuit boards in a 2273/2273V Band Printer or when returning Band Printer boards to the Home Office. The particular item(s) on each board that are of importance during this consideration follow the circuit board descriptions and part numbers given below.

- 1) Processor Board, WL #726-1105 (OEM #257315-001); band time-out switch, operate-program PROM's, and band-image PROM('s).
- 2) Centronics Interface Board, WL #726-1108 (OEM #257265-001); configuration switches, FLSS PROM, and data-decode PROM.
- 3) Timing & Status Board, WL #726-1107 (OEM #257325-001); print-inhibit switch, band-speed header, and programmable header.
- 4) Hammer Driver Board, WL #726-1101 (OEM #251165-001); hammer flight-time header.

The items concerned can be divided into two groups:

- 1) PROM's and headers (jumper plugs).
- 2) switch settings.

These groups are covered in the following two sections.

1. PROM'S AND HEADERS (JUMPER PLUGS)

A. PROM'S

The five operate-program PROM's (MEM1-MEM5) and the band-image PROM('s) (MEM6-MEM8) on the Processor Board (ref: FIGURE 1) are not loaded on circuit boards obtained from the Home Office. The same is true for the FLSS PROM (MEM1) and the data-decode PROM (MEM2) on the Centronics Interface Board (ref: FIGURE 2). When returning one of these boards to the Home Office, remove the PROM's so they may be inserted into an incoming board. If necessary, the PROM's may be ordered from the Home Office under the following part numbers:

<u>WL #</u>	<u>PROGRAM PROM KITS (5 PROM'S)</u>	<u>OEM #</u>
726-1217	300 LPM	250531-001
726-4418	600 LPM	257204-001

<u>WL #</u>	<u>BAND IMAGE PROM'S</u>	<u>OEM #</u>
725-2598	48 Character Utility, 300/600 LPM	250536-023
725-2617	64 Character Utility, 300/600 LPM	250525-019
725-2600	96 Character, U/L Case, 300/600 LPM	250529-022

<u>WL #</u>	<u>DESCRIPTION</u>	<u>OEM #</u>
726-1110	Data-Decode PROM, 300/600 LPM	257290-001
726-1152	FLSS PROM, 300/600 LPM	249320-001

NOTE:

The FLSS PROM is only used in parallel versions of the Band Printer.

OPERATE PROGRAM PROM'S
(MEM1 - MEM5)

BAND IMAGE PROM(S)
(MEM6 - MEM8)

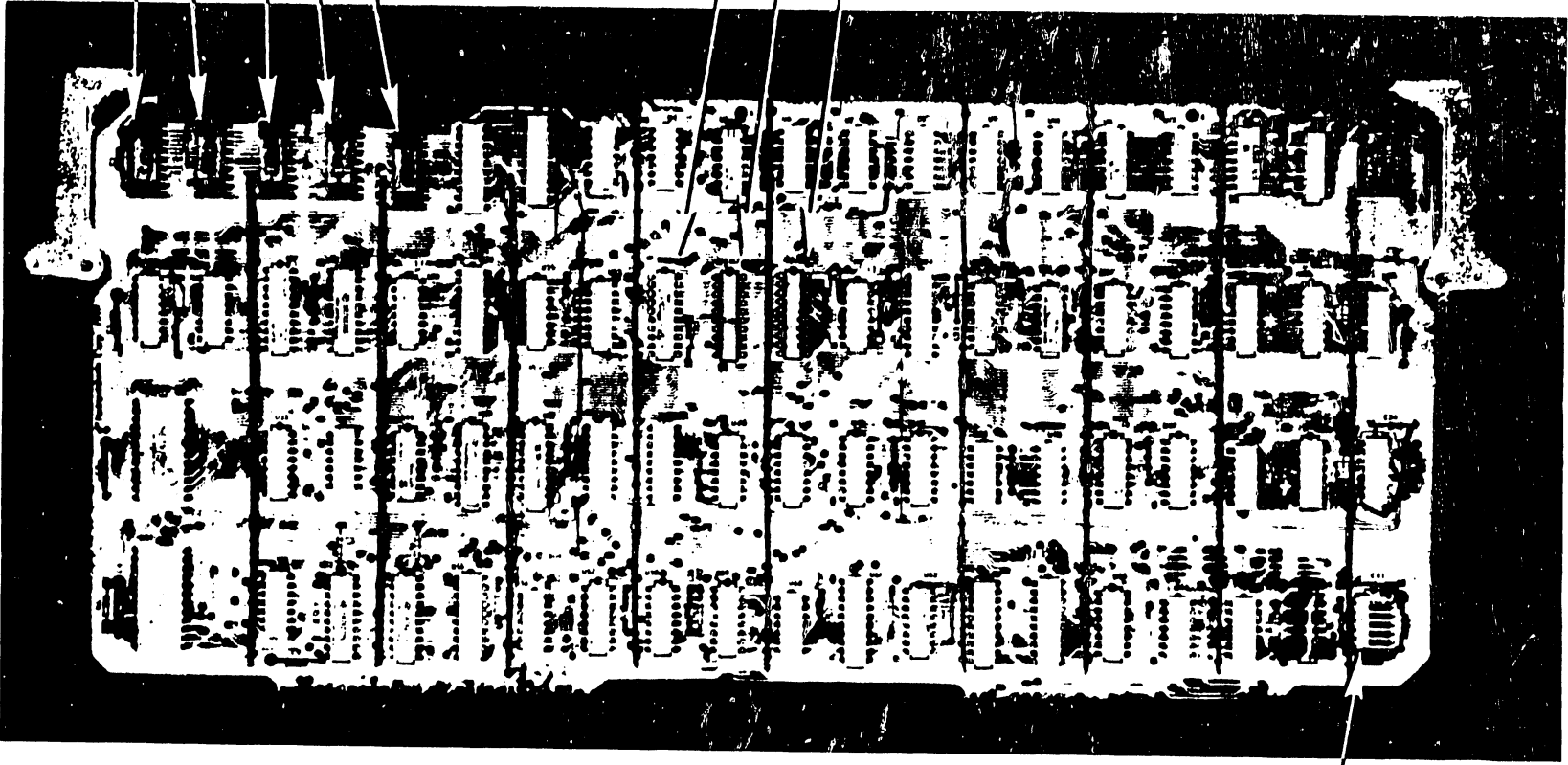

BAND TIME-
OUT SWITCH
(S1)

FIGURE 1. PROCESSOR BOARD

*FLSS PROM
LOCATION
(MEM1)

DATA DECODE
PROM (MEM2)

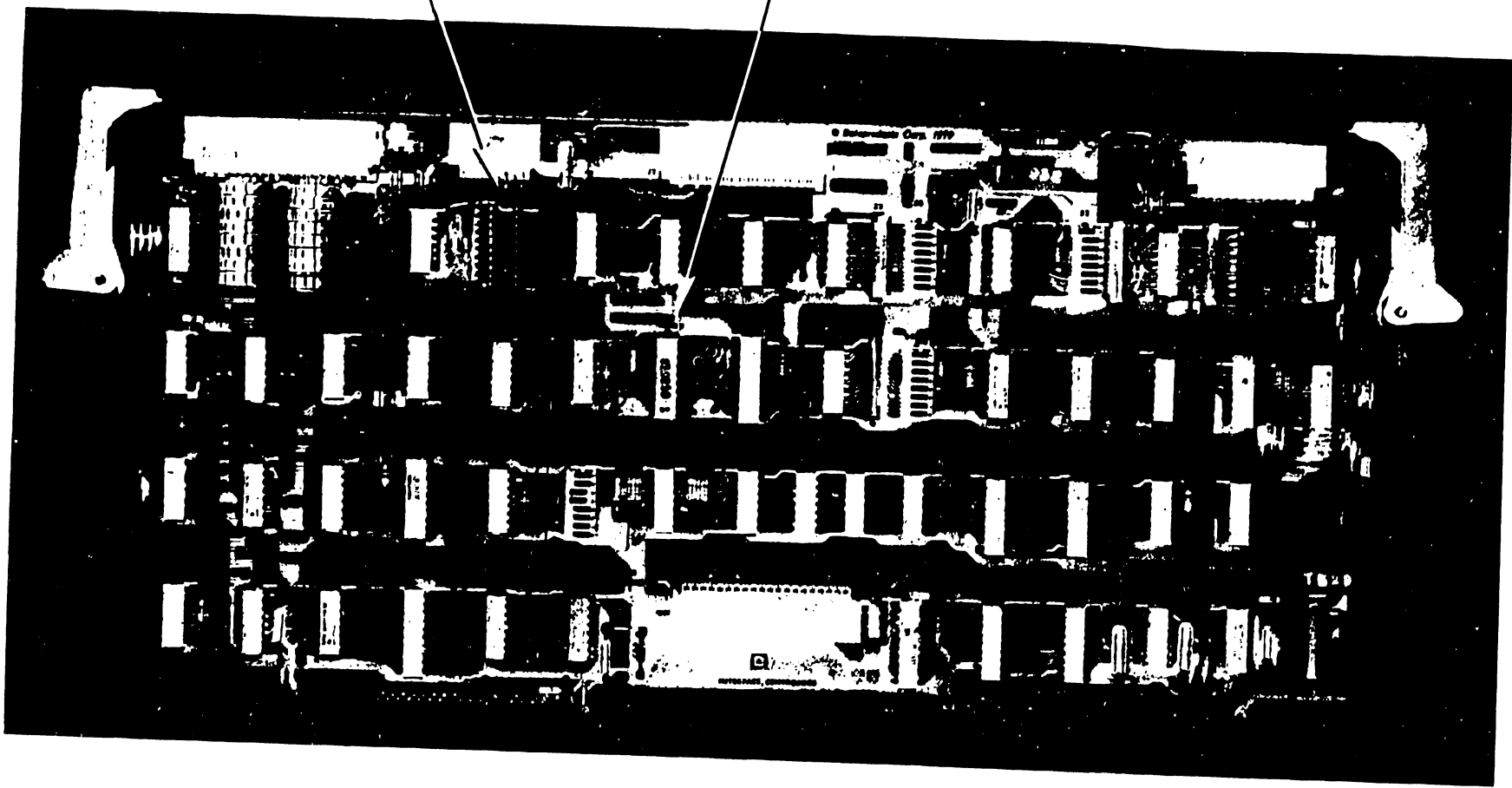

*PARALLEL
VERSIONS
ONLY

FIGURE 2. CENTRONICS INTERFACE BOARD

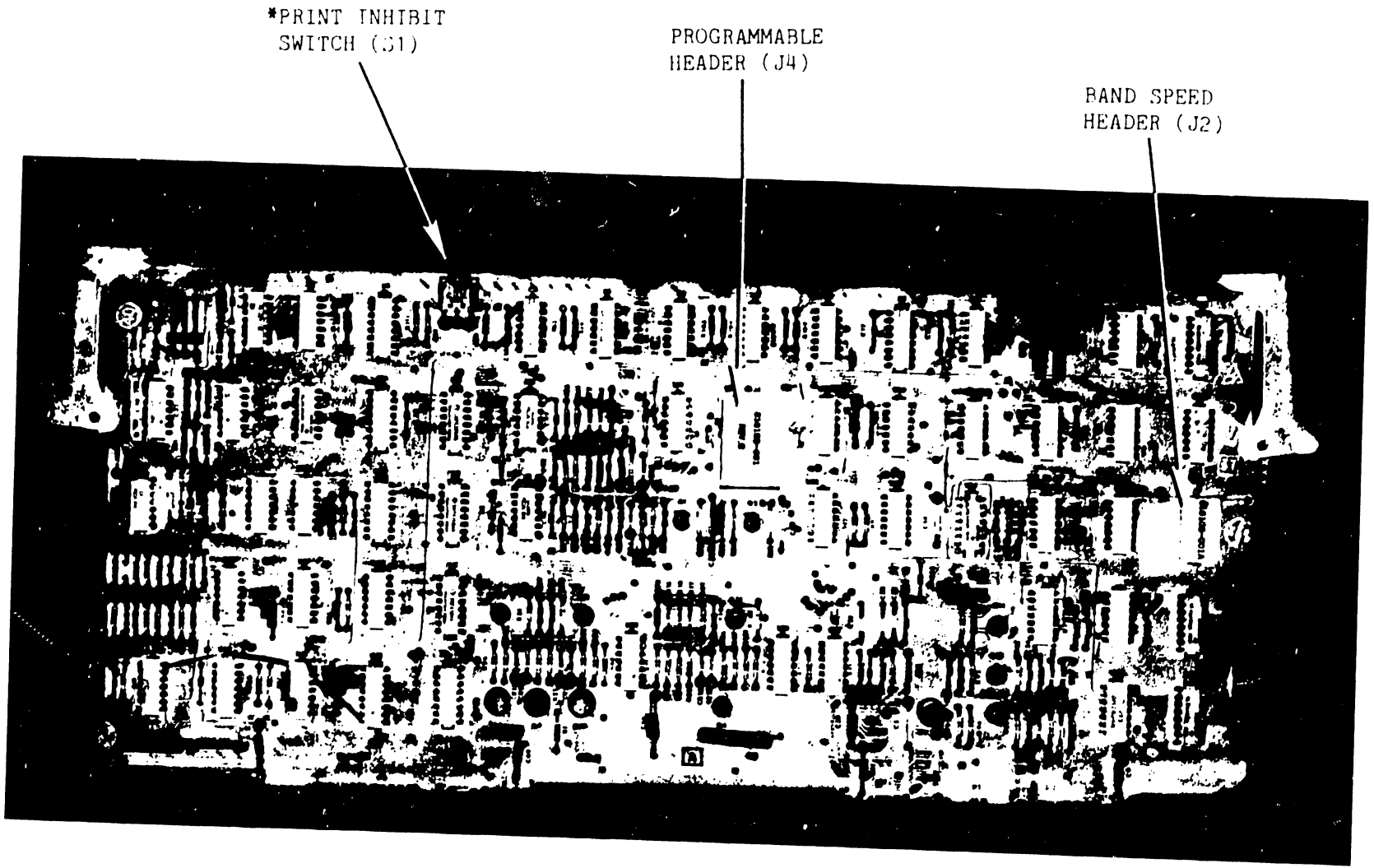

*SHOWN IN
DISABLED
POSITION

FIGURE 3. TIMING & STATUS BOARD

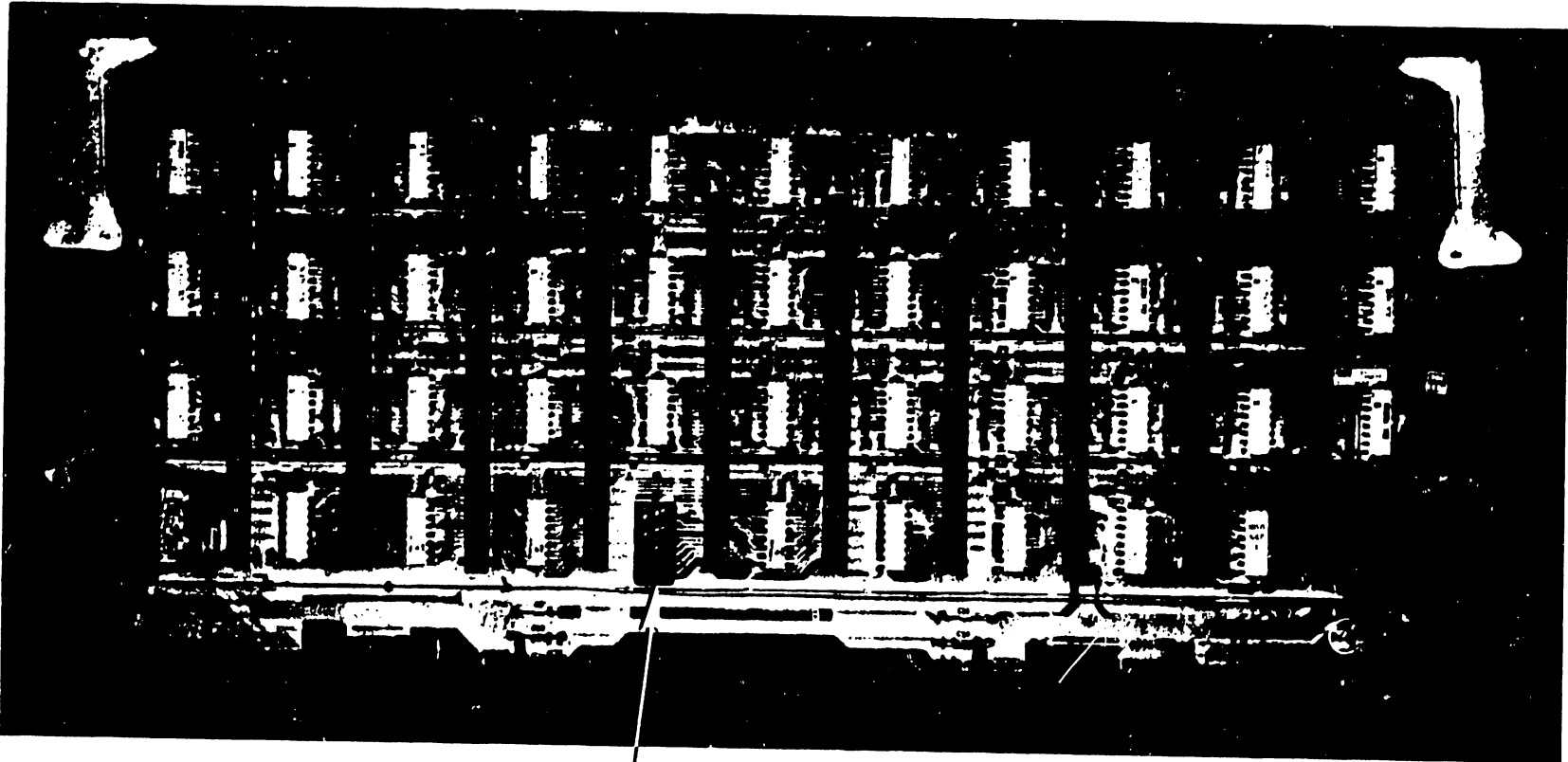

FLIGHT TIME
HEADER (J18)

FIGURE 4. HAMMER DRIVER BOARD

B. HEADERS (JUMPER PLUGS)

The band-speed header (J2) and the programmable header (J4) (both on the Timing & Status Board; refer to FIGURE 3) and the hammer flight-time header (J18) (on the Hammer Driver Board; refer to FIGURE 4), like the PROM's mentioned in Section A, are not loaded in circuit boards distributed by the Home Office Customer Engineering Department. Remove all headers from these boards before returning the boards to the Home Office. Part numbers to be used when ordering are:

<u>WL #</u>	<u>DESCRIPTION</u>	<u>OEM #</u>
726-1211	Band-Speed & Programmable Header Kit, 300 LPM	257435-001
726-1212	Band-Speed & Programmable Header Kit, 600 LPM	257435-003
726-1213	Flight-Time Header, 300 LPM	257436-001
726-1214	Flight-Time Header, 600 LPM	257436-003

2. SWITCH SETTINGS

- A. The print-inhibit switch (S1) on the Timing & Status Board (ref: FIGURE 3) must be in the "disable" position to allow the hammer drivers to operate. When replacing the Timing & Status Board, ensure this switch is in the correct position.

- B. There are four configuration switches (bank-type) on the Centronics Interface Board. Ensure switch settings are correct when replacing the Interface Board. 300 lpm units and 600 lpm units have identical switch settings. FIGURE 5 shows the correct switch settings for the parallel version of the Band Printer; FIGURE 6 shows the correct switch settings for the serial version of the Band Printer. An explanation of the significance of each individual switch follows.

NOTE: X = Not used

SWITCH BANK 1

- 1- X
- 2- X
- 3- OFF: Data 80-bit enabled
- 4- OFF: Input PRIME disabled
- 5- OFF
- 6- X
- 7- X
- 8- OFF: Parity option disabled

SWITCH BANK 2

- 1- OFF: No printer supplied line feed after carriage return
- 2- OFF: Skip 3 lines at bottom of form
- 3- OFF: Skip 3 lines at bottom of form
- 4- OFF: Print to bottom of form when paper runs out
- 5- OFF: No line feed after carriage return due to buffer full
- 6- OFF: Default to 11-inch form
- 7- OFF: DELETE (HEX 7F) disabled
- 8- OFF: Error after 8 carriage returns without linefeed
ON: Error after 140 carriage returns without linefeed

SWITCH BANK 3

- 1- OFF: Bottom of form skip over disabled
- 2- OFF: No print on paper feed command
- 3- OFF: Single space
- 4- X
- 5- OFF: Tape read not available
- 6- X
- 7- X
- 8- X

SWITCH BANK 4

- 1- OFF
- 2- OFF
- 3- OFF
- 4- OFF
- 5- OFF: Do not shorten step-count on bottom of form
- 6- X
- 7- X
- 8- X

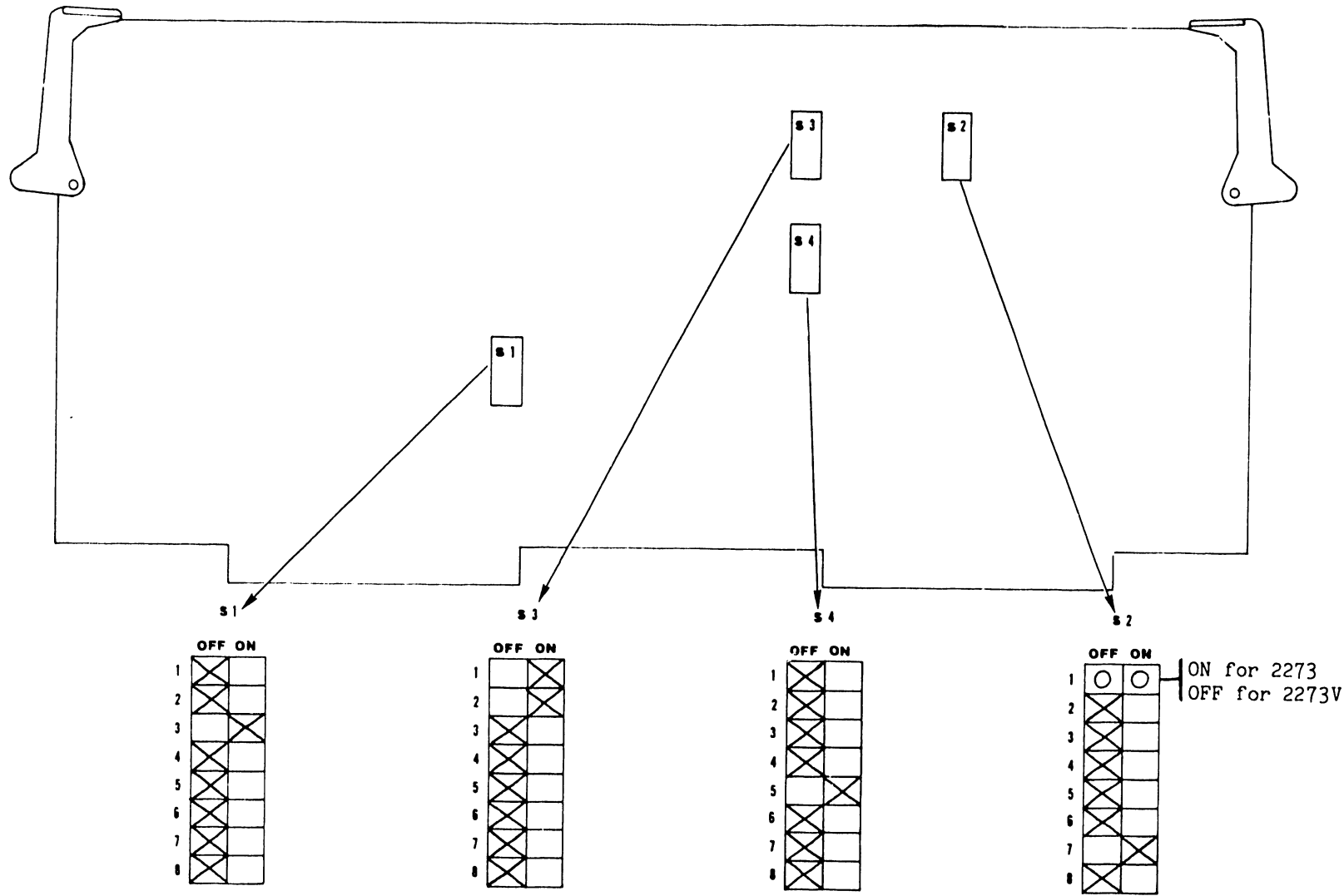

FIGURE 5. PARALLEL PRINTER CONFIGURATION SWITCH SETTINGS

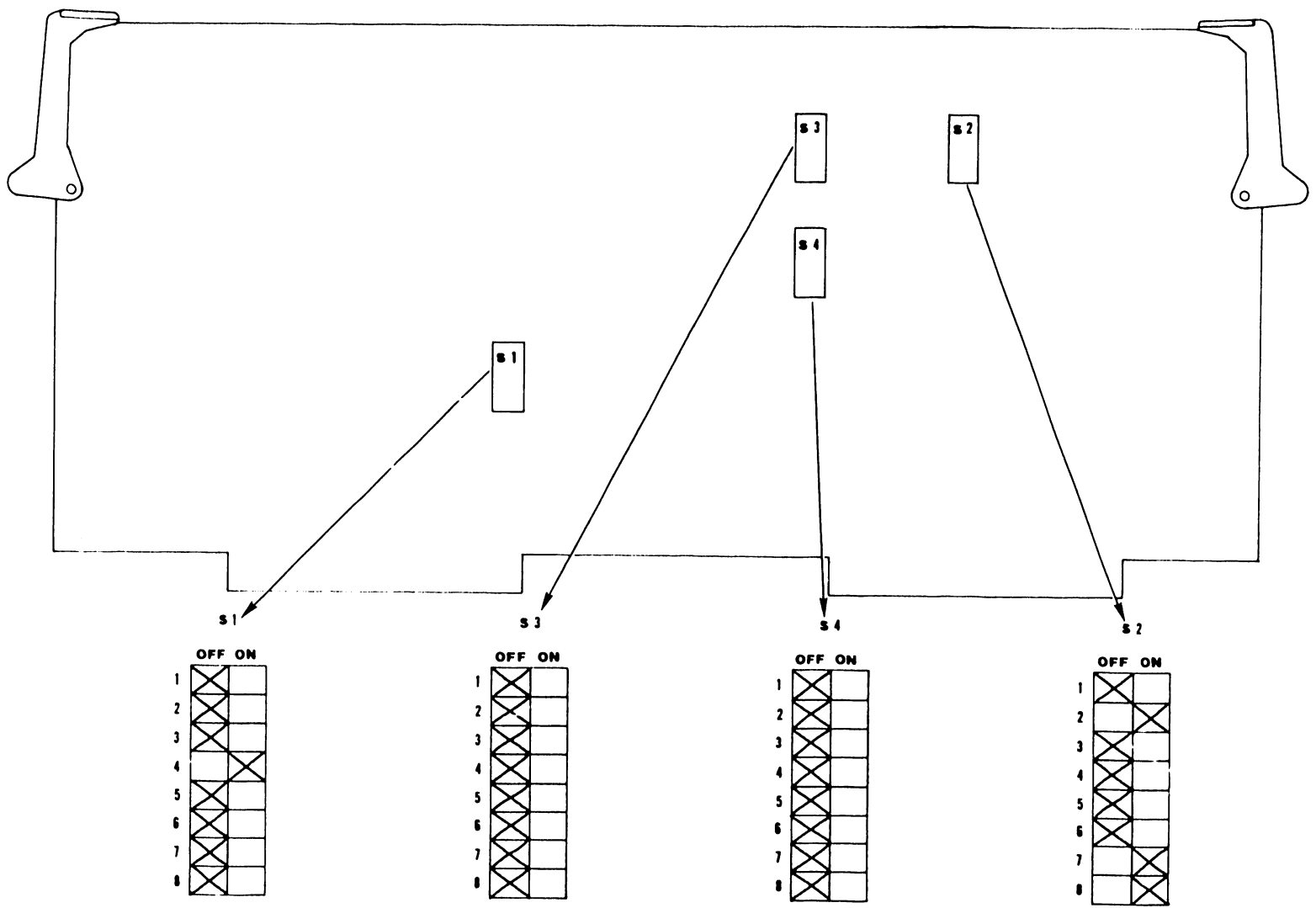
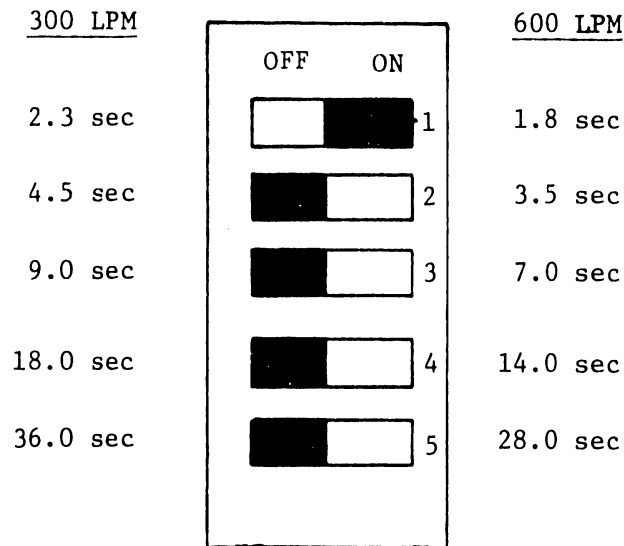

FIGURE 6. SERIAL PRINTER CONFIGURATION SWITCH SETTINGS

C. The new type Processor Board (OEM #257315-001, WL #726-1105) has a bank-type, band time-out switch (S1) loaded in location U69. Ensure that the switch is set correctly when replacing the Processor Board. The switch setting is the same for 300 lpm and 600 lpm units. The setting is also the same for serial and parallel versions of the Band Printer. (Refer to FIGURE 1 and the figure below.)



NOTE:

1. The band time-out switch is not loaded in old type Processor Boards (OEM #251770-001, WL #726-1105).
2. If all the band time-out switches are OFF, the band will not start.
3. If a customer wishes, the time-out may be increased by having the Customer Engineer activate the appropriate switch or switches until the desired time is selected. If more than one switch is activated, add each switch delay time for the actual delay.

PSN

IIIIC10-2

PRODUCT SERVICE NOTICE

DATE : 1/28/80

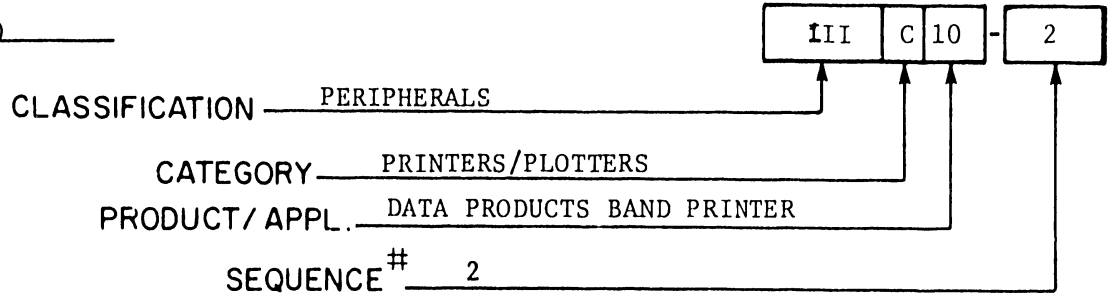

TITLE:

HAMMER BANK MAGNET MISALIGNMENT/
HAMMER MODULE REPLACEMENT PROCEDURE

The rare-earth magnets used in the 2273V/5573/5574 Band Printer Hammer Bank Assemblies are assembled, aligned, and magnetized during manufacture and, once mounted on an assembly, are non-adjustable. If an individual magnet or a magnet assembly becomes damaged or misaligned through accident or wear, the entire hammer bank assembly must be replaced.

The hammer bank magnets provide an opposing force to an energized hammer, causing the hammer to move forward, striking the paper, inked printer ribbon, and character band. Individual hammers are mounted in hammer modules, which are attached to the hammer bank assembly by means of a screw located on the rear of the assembly; each magnet assembly is attached in the same manner.

The hammer module screws are located next to the magnet assembly screws. Care must be taken to ensure that the correct screw is removed when replacing a damaged hammer module. Refer to the hammer module removal procedure and Figures 1, 2, 3, and 4 on the following pages.



*****CAUTION*****

IF A MAGNET ASSEMBLY SCREW IS LOOSENED IN ERROR,
MAGNET ALIGNMENT IS LOST AND THE ENTIRE HAMMER
BANK ASSEMBLY MUST BE REPLACED.

Hammer Bank Assembly and Hammer Module part numbers are as follows:

2273V-1 (PARALLEL)/5573 (SERIAL) BAND PRINTERS (250 LPM):

Hammer Bank Assembly	726-1192
Hammer Module	726-1135

5574 BAND PRINTER (SERIAL; 600 LPM):

Hammer Bank Assembly	726-1210
Hammer Module (upper)	726-1208
Hammer Module (lower)	726-1209

Remove a hammer module as follows:

(See Figures 1, 2, 3, and 4.)

- a. Power-down the printer.
- b. Remove the printer top cover.
- c. Remove the two screws located on the front of the hammer bank mask. Pull the mask up and away from the assembly.
- d. On the Hammer Driver Board, unplug the Molex connector of the hammer module to be removed.
- c. Locate the appropriate hammer module screw and remove it using a 7/64" Allen wrench.
- d. Pull the module out of the hammer bank assembly.

To re-install a module, reverse the above procedure.

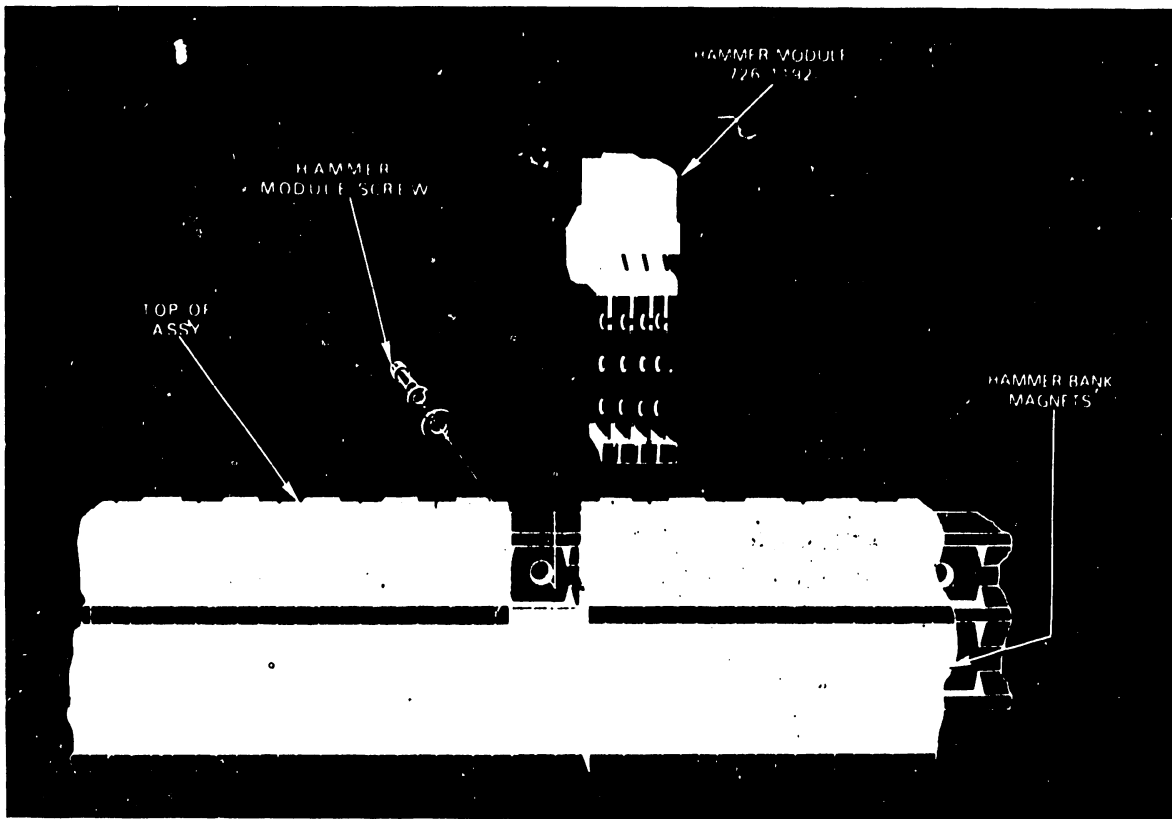

FIGURE 1 Hammer Bank Assembly (726-1192), Front View

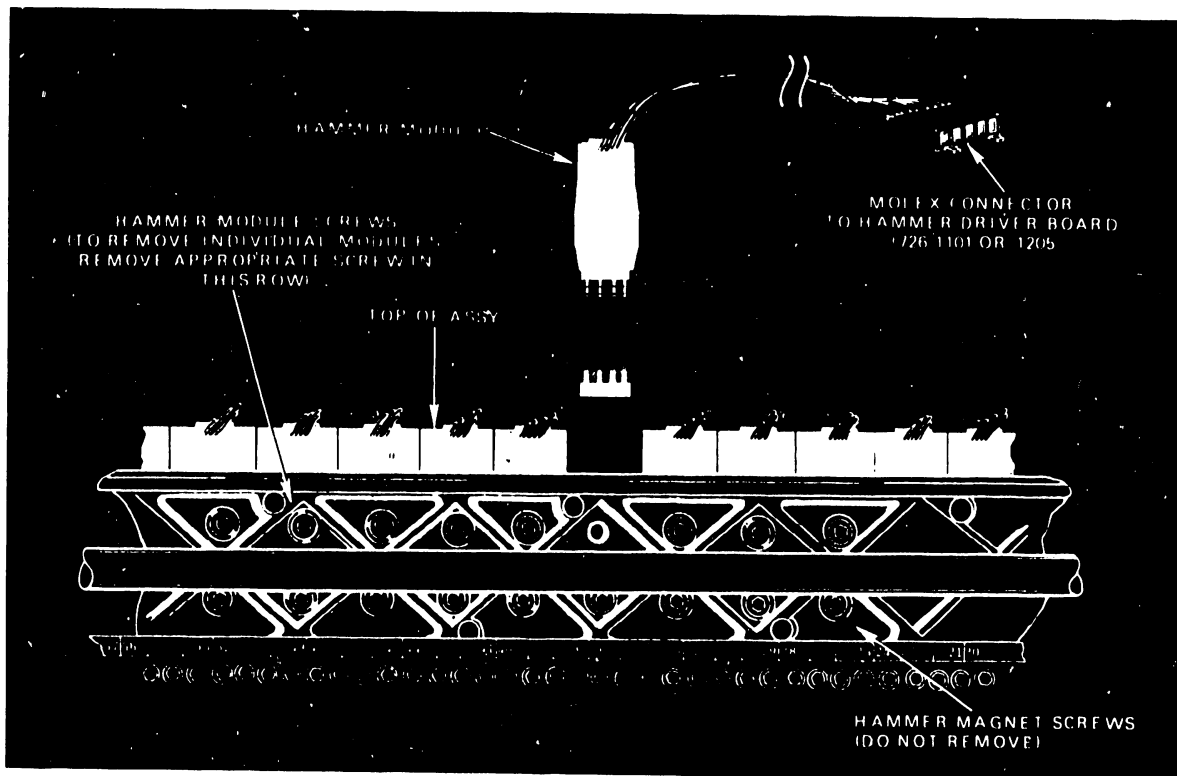

FIGURE 2 Hammer Bank Assembly (726-1192), Rear View

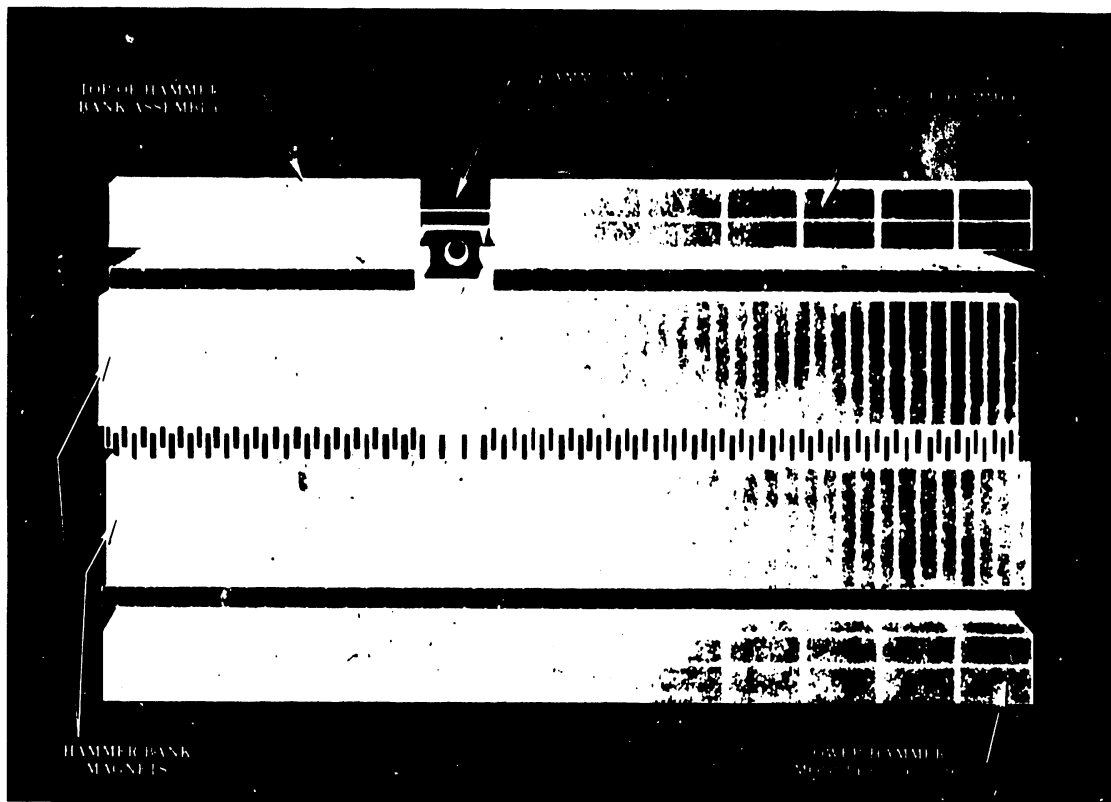

FIGURE 3 Hammer Bank Assembly (726-1210), Front View

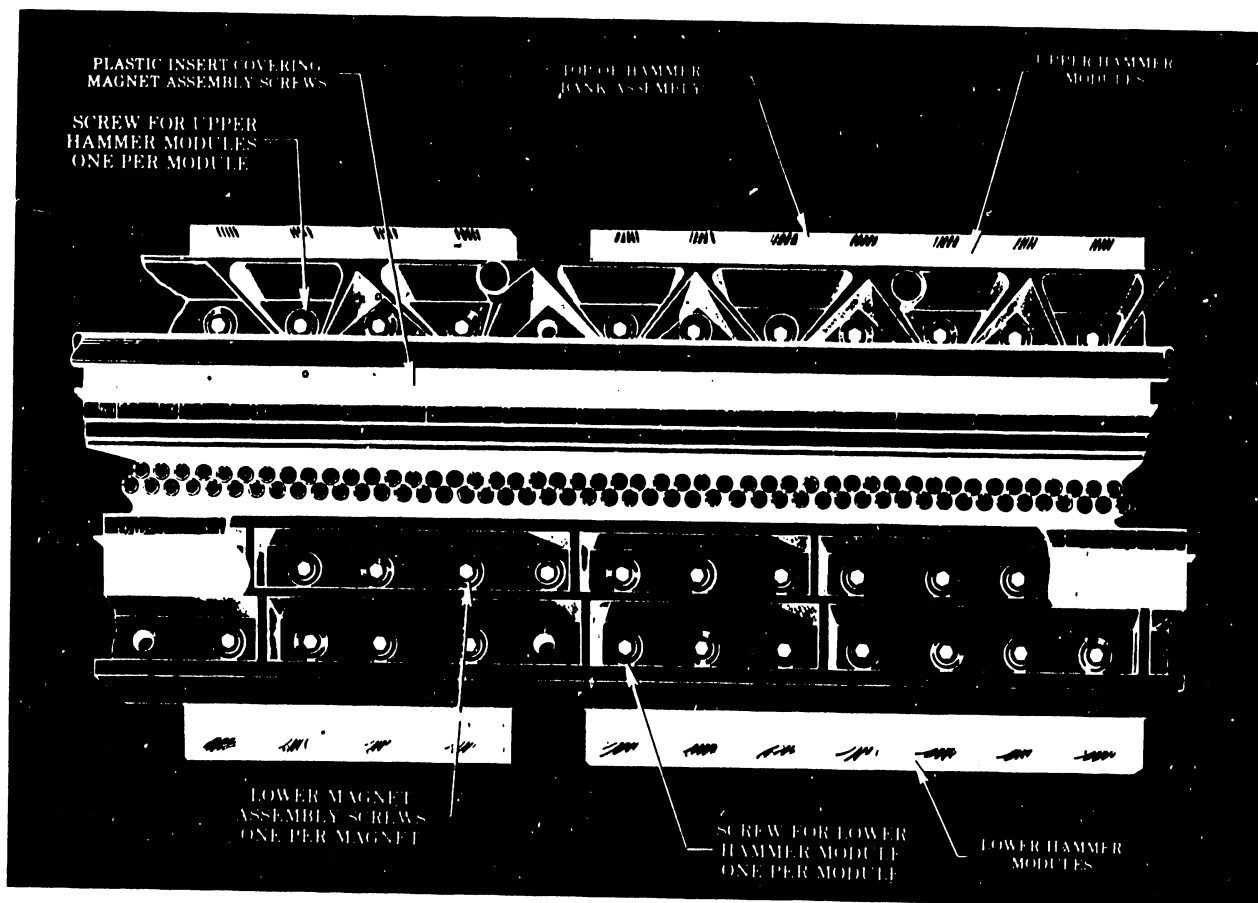

FIGURE 4 Hammer Bank Assembly (726-1210), Rear View

PSN

IIIIC10-4

PRODUCT SERVICE NOTICE

DATE : 10/20/81

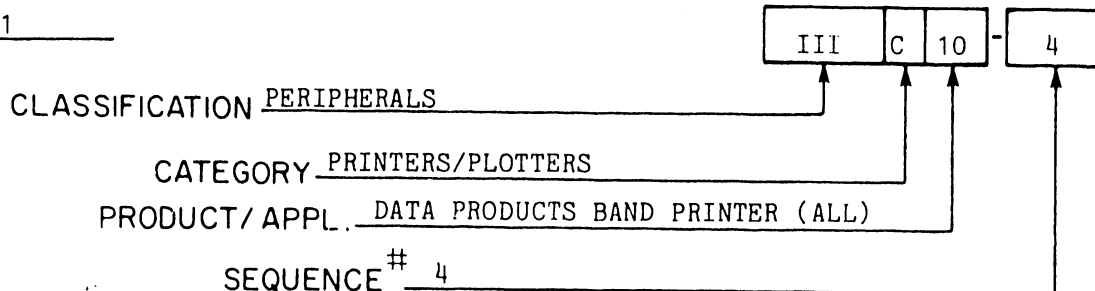

TITLE:

DATA PRODUCTS BAND PRINTER
PAPER STATIC ELIMINATION MODIFICATION

This PSN applies to Wang Models 2273-1, 2273V-1, 2273-2, 5573, and 5574, (Data Products Models B300 and B600), all versions.

The PSN contains instructions for the installation of the paper static elimination modification for:

1. a. All 2273-1, 2273V-1, and 2273-2 parallel interface printers. Refer to figure 1 to identify parallel interface printers.
- b. Old versions of the 5573 and 5574 serial interface printer using the "Black Box" Printer Interface (PIO). The old serial printer terminator will have both the standard 36-pin parallel connector and a 25-pin RS232 connector. Refer to figure 2 to identify old versions of the serial interface printers.
2. New versions of the 5573 and 5574 serial printer. These printers do not use the "Black Box" Printer Interface (PIO). The printer will be directly connected to the host system by a coaxial cable. Refer to figure 3 to identify new versions of the serial interface printers. The new versions of the 5573 and 5574 printer will also contain the 7519 CPU and Memory Motherboard and the 7520 Data Link and Printer Controller PC cards.

A. REASON FOR CHANGE

The following are symptoms caused by paper static:

1. Printer de-selects or displays random error codes with no set pattern.
2. Paper does not stack correctly.
3. Printer operator receives a static shock when touching the printer or the stacked paper.



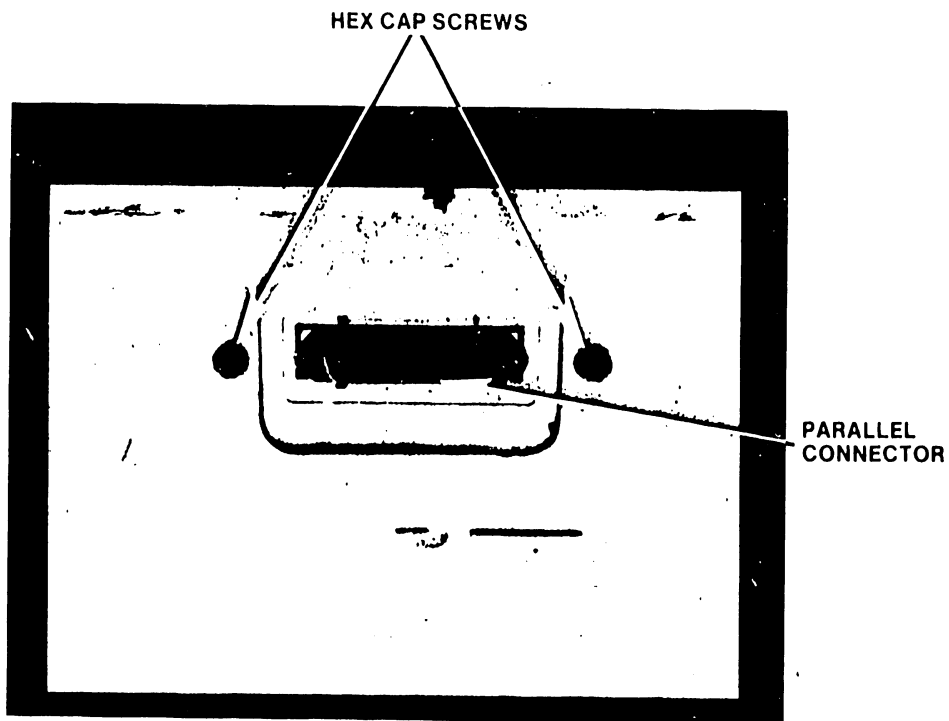

FIGURE 1
2273-1, 2273V-1, AND 2273-2 PARALLEL CONNECTOR

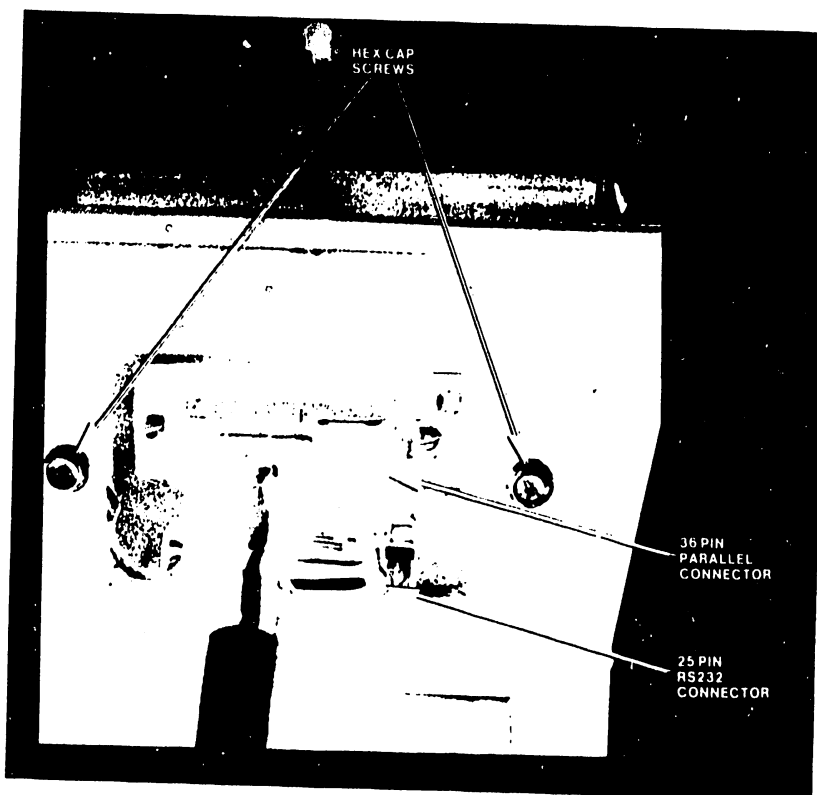

FIGURE 2
OLD STYLE 5573 AND 5574 SERIAL CONNECTORS

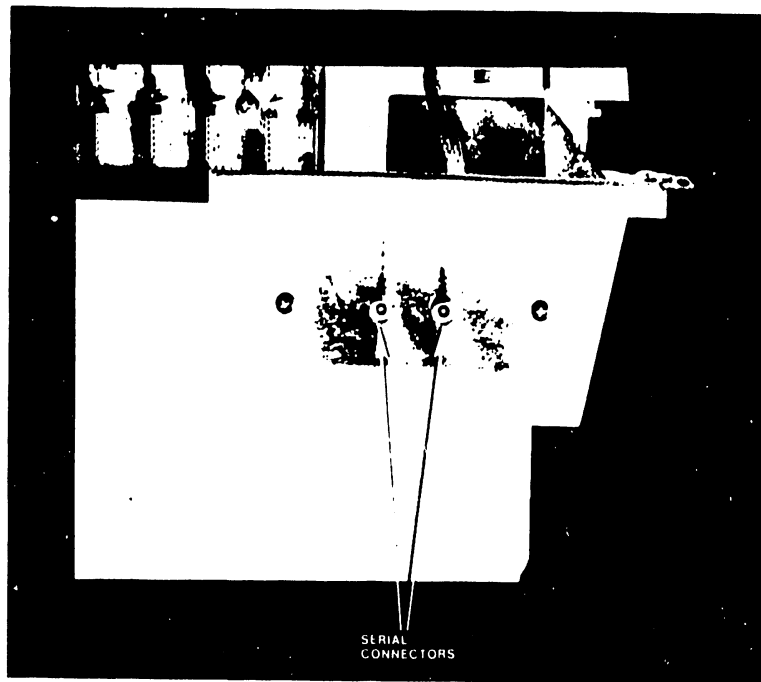

FIGURE 3
NEW STYLE 5573 AND 5574 SERIAL CONNECTORS

B. INSPECTION OF PRINTER BASE

Inspect the printer base before installing the paper static elimination modification. If the inside of the printer base is coated with a zinc arc spray coating - a dull, gray colored finish with a rough texture - contact Customer Engineering Home Office Printer Support Group before proceeding with this modification.

C. PARTS REQUIRED

1. A kit containing parts to install the modifications in all printers is available under the following part number: P/N 728-0006

The part numbers of the items included in the kit are as follows:

<u>PART NUMBER</u>	<u>DESCRIPTION</u>	<u>QUANTITY</u>
451-2378	Cover, PC card	1
452-0192	Plate, ground	1
458-0740	Connector, ground	2
458-1063	Tinsel assembly	3
465-1635	Spring, 0.250 O.D., 2" long	2
654-1010	Lug, ground, #10	2

(The old style PC card cover and ground plate removed from the printer may be disposed of after the modification is complete. Spare ground connectors and tinsel assemblies may be put in stock.)

D. INSTALLING PAPER STATIC ELIMINATORS IN ALL PARALLEL AND OLD SERIAL PRINTERS

1. Turn the printer ac power breaker OFF and remove the printer power plug from the ac source, after having identified the printer as a 2273-1, 2273V-1, 2273-2, or old style serial 5573 and 5574.

2. Remove the two-5x45mm Metric hex-head cap screws, holding the printer cover, from underneath the left and right sides of the front edge of the printer base. Refer to figure 4. Then remove and set aside the cover. An 8mm nut driver may be used to remove most of the Metric cap screws.

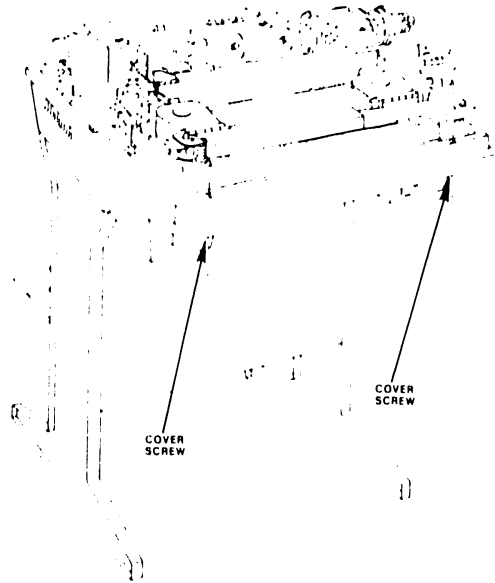

FIGURE 4
PRINTER BASE

3. Remove the old style PC card cage cover by unlocking the two fraction turn fasteners on the card cage cover. (Figure 5.)

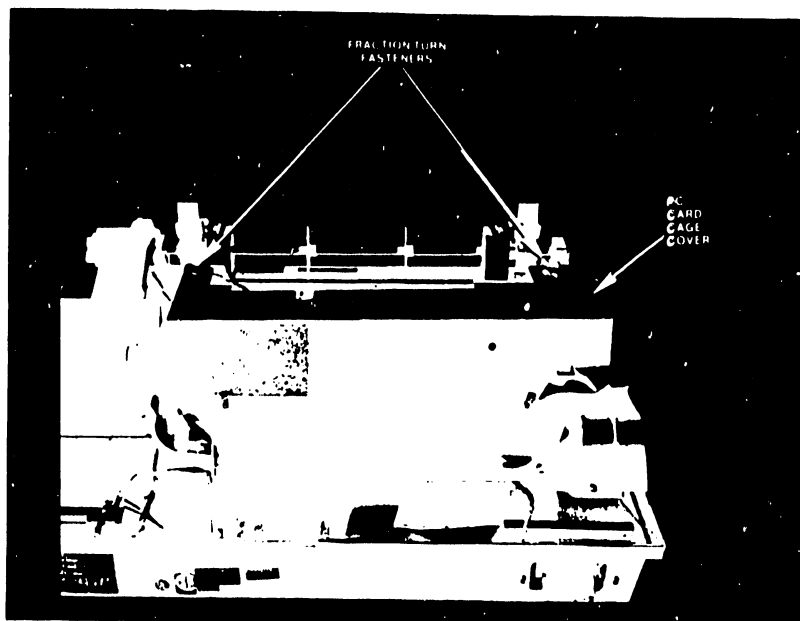

FIGURE 5
OLD STYLE PC CARD CAGE COVER

4. Remove the two fraction turn fasteners from the card cage cover as follows:
 - a. Grasp the wing nut with the right hand.
 - b. Grasp the metal lock with the left hand.
 - c. Push hands together to compress the rubber spacer.
 - d. Maintain a secure hold on the metal lock and turn the wing-lock 1/4 turn counter-clockwise to disengage. (Figure 6.)

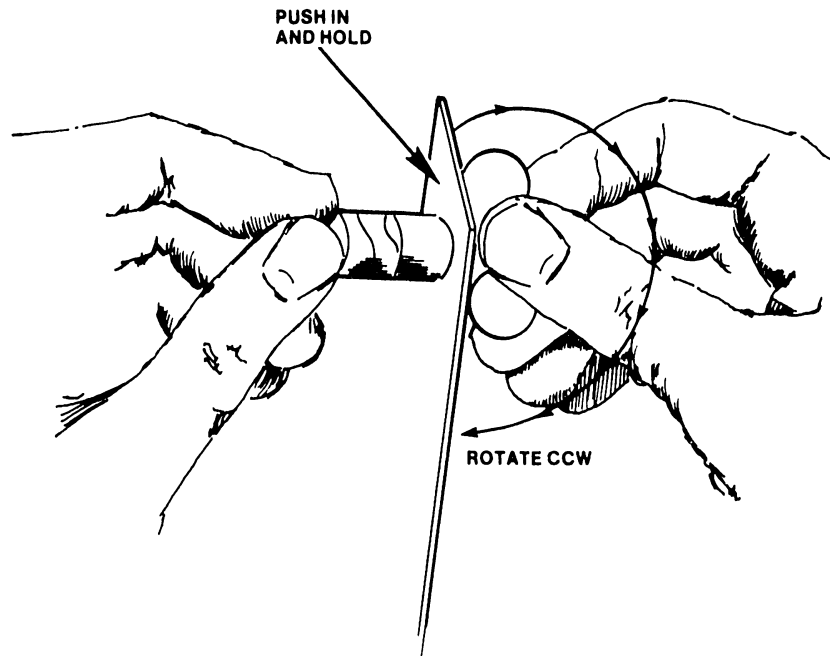

FIGURE 6
FRACTION TURN FASTENER REMOVAL

- e. Remove the metal lock, nylon lock, and rubber spacer from the wing-lock shaft. (Figure 7.)
- f. Save the parts of the fraction turn fasteners for installation in the new PC card cage cover.

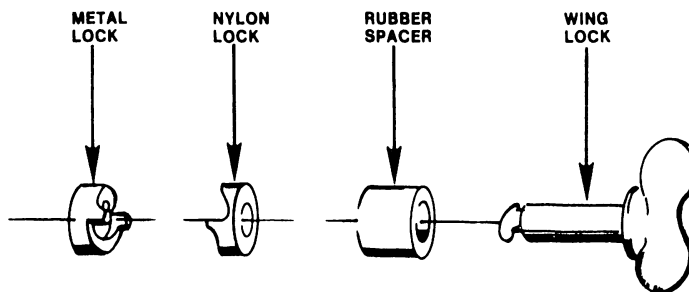

FIGURE 7
FRACTION TURN FASTENER ASSEMBLY

5. Remove the two-5x11mm Metric hex-head cap screws (figure 1 or 2) holding the terminator assembly (shown in figure 8) to the rear of the base. Disconnect the terminator cable from the bottom of the Interface PC card (figure 9), remove the green and yellow ground wire from the terminator, and lift out the terminator assembly. (The ground wire may not be installed in some printers.) Use a 7mm nut driver to remove the cap screw securing the ground wire.

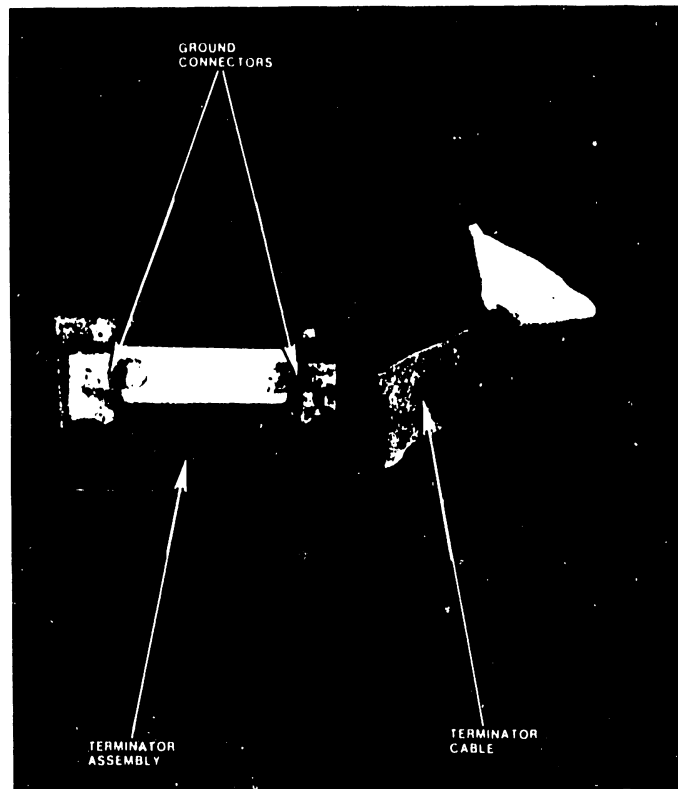

FIGURE 8
GROUND CONNECTORS

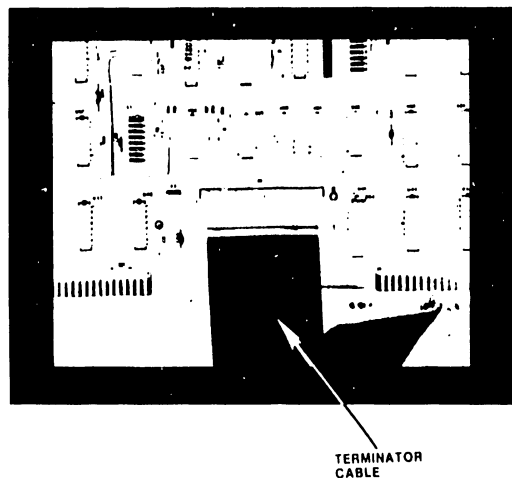

FIGURE 9
INTERFACE PC CARD

6. Install two ground connectors on the terminator as shown in figure 8.
7. Install the new ground plate (figure 10) as shown in figure 11. Be sure that the lip of the ground plate overhangs the edge of the printer base.

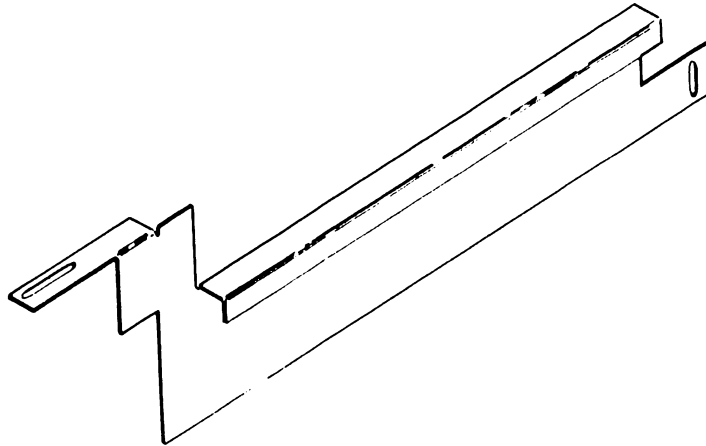

FIGURE 10
GROUND PLATE

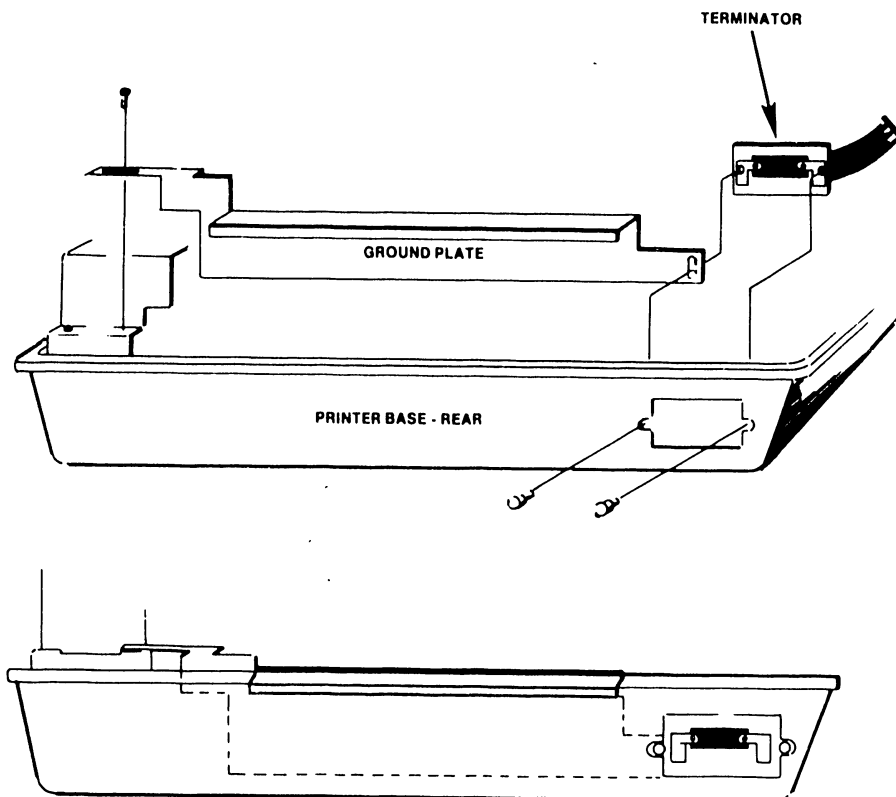

FIGURE 11
GROUND PLATE INSTALLATION

8. Reinstall the ground wire, terminator cable, and terminator assembly as they were removed in step 5. (Page 6.)
9. Install the fraction turn fasteners onto the new PC card cage cover by reversing the procedure of step 4. (Page 5.)
10. Install the new PC card cage cover (figure 12). Be sure there is good mechanical contact between the card cage cover and the ground plate.

NOTE

It may be necessary to bend the rear plate of the PC card cage cover out to make good mechanical contact with the ground plate. Refer to figure 13.

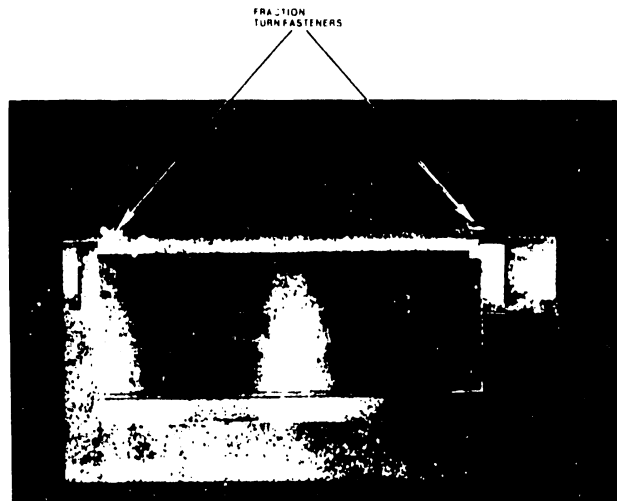

FIGURE 12
PC CARD CAGE COVER

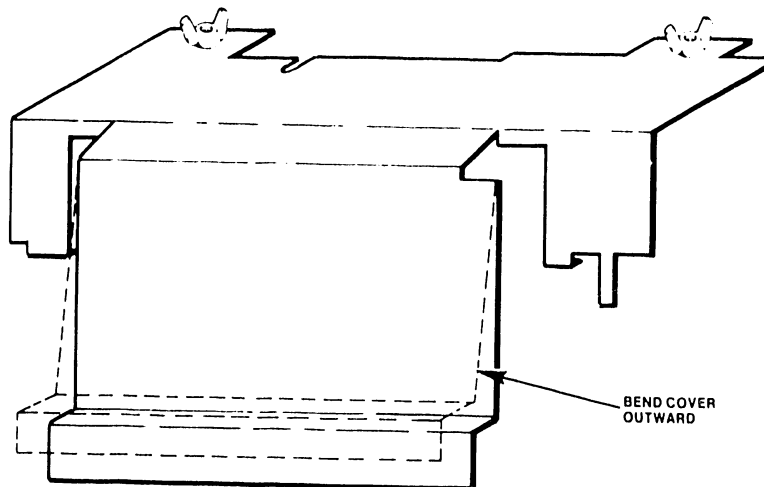

FIGURE 13
GROUND PLATE CONTACT

11. Install three tinsel assemblies (figure 14) as follows:

- a. Remove the two-5x11mm Metric hex-cap screws from the hammer bank mask. (Figure 15.) Remove the hammer bank mask from the printer. Make two small notches on the top of the hammer bank mask, 3/8" from the front of the mask, with a small pair of wire cutters or a file. Install a tinsel assembly between the two notches. Reinstall the mask on the printer. Make sure that the tinsel barely overhangs the front of the mask. If the tinsel assembly is too far forward, the paper will be pushed out and will cause ribbon smudging.



FIGURE 14
TINSEL ASSEMBLY

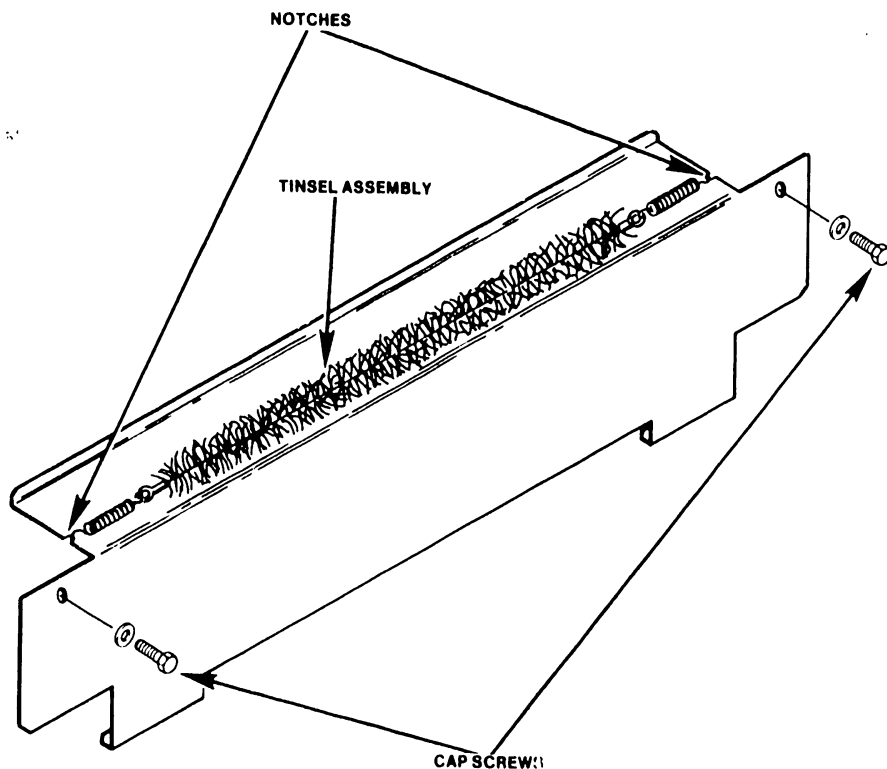

FIGURE 15
HAMMER BANK MASK

NOTE

Some printers may have a tinsel assembly, previously installed by Data Products Corp., across the top of the hammer bank mask. Relocate these tinsel assemblies as instructed above.

- b. Install two tinsel assemblies inside the paper exit chute at the rear of the printer cover. Refer to figure 16.
- c. Remove the two-5x11mm Metric hex-cap screws from the the printer cover. Refer to figure 17. Install two-#10 lugs, and replace the cap screws. Connect two large springs between the #10 lugs and the paper exit chute.

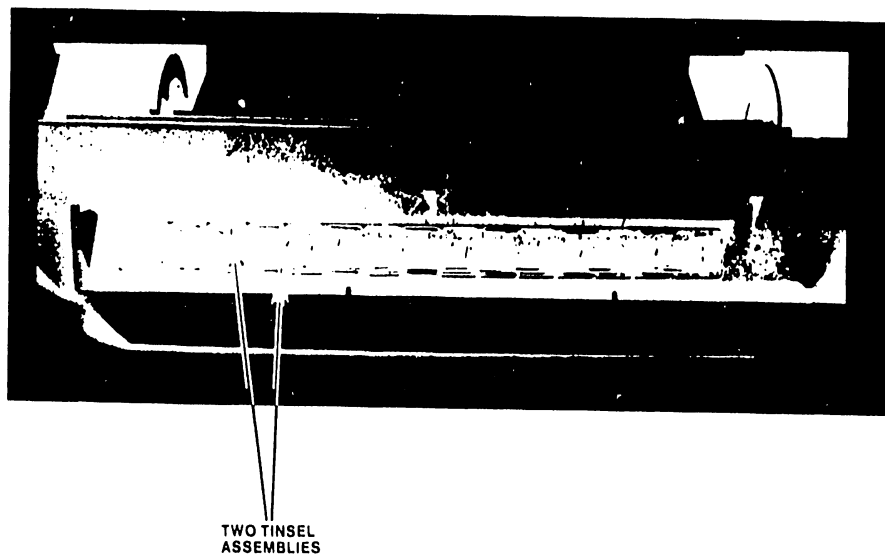

FIGURE 16
PAPER EXIT CHUTE

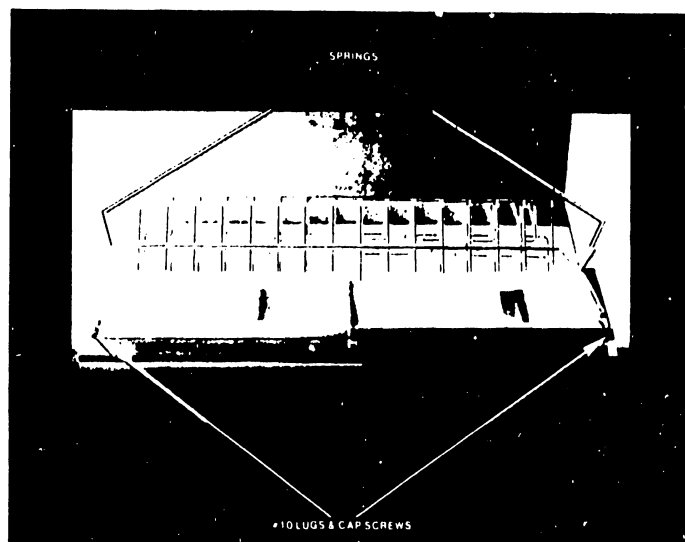

FIGURE 17
INSIDE PRINTER COVER

12. a. Reroute the Keyboard cable as shown in the before and after figures 18 and 19.

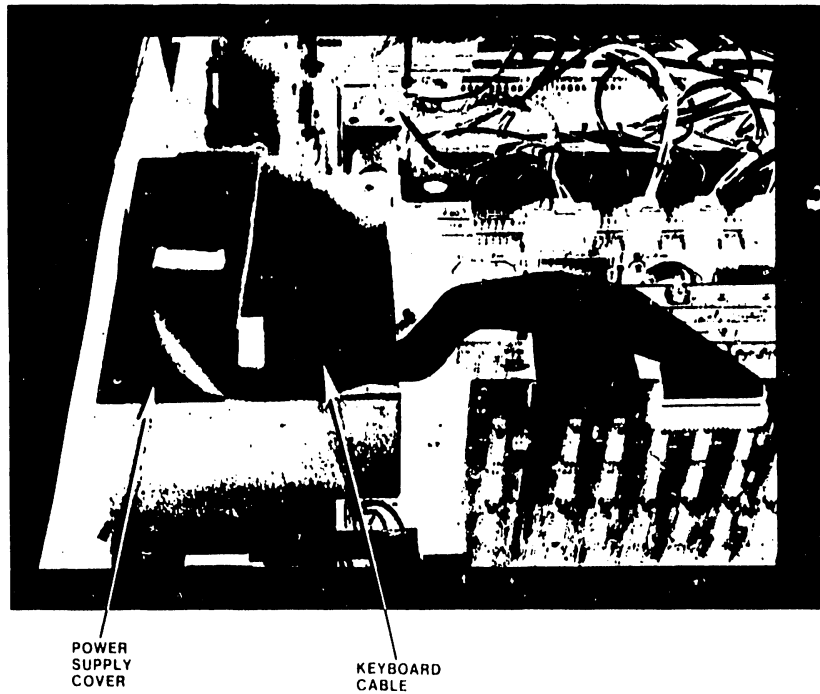

FIGURE 18
KEYBOARD CABLE BEFORE REROUTING

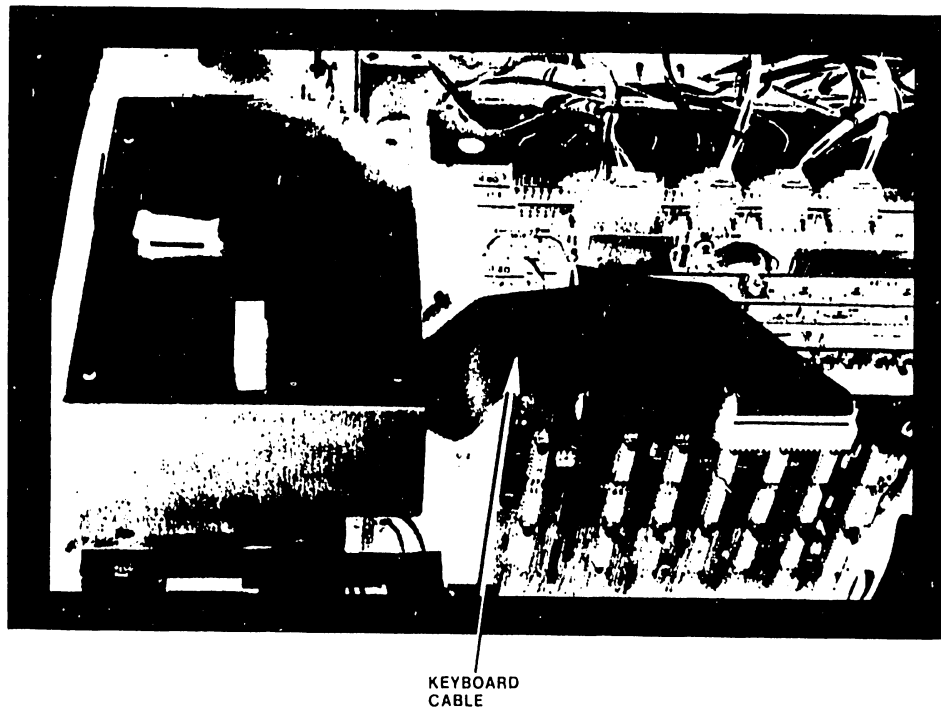

FIGURE 19
KEYBOARD CABLE AFTER REROUTING

- b. Reroute the Interlock cable as shown in figure 20.



FIGURE 20
INTERLOCK CABLE REROUTING

13. Reinstall the printer cover assembly

E. PRINTER PEDESTAL AND PAPER SHELF CHECK.

1. Remove the paper shelf and clean behind the four pedestal slots with a piece of emory cloth. Refer to figure 21.
2. Clean the ends of the paper shelf hangers with a piece of emory cloth.
3. Replace the paper shelf and measure the resistance between the paper shelf and the printer pedestal (ground) with a digital volt meter. The resistance should not measure more than 2 ohms.

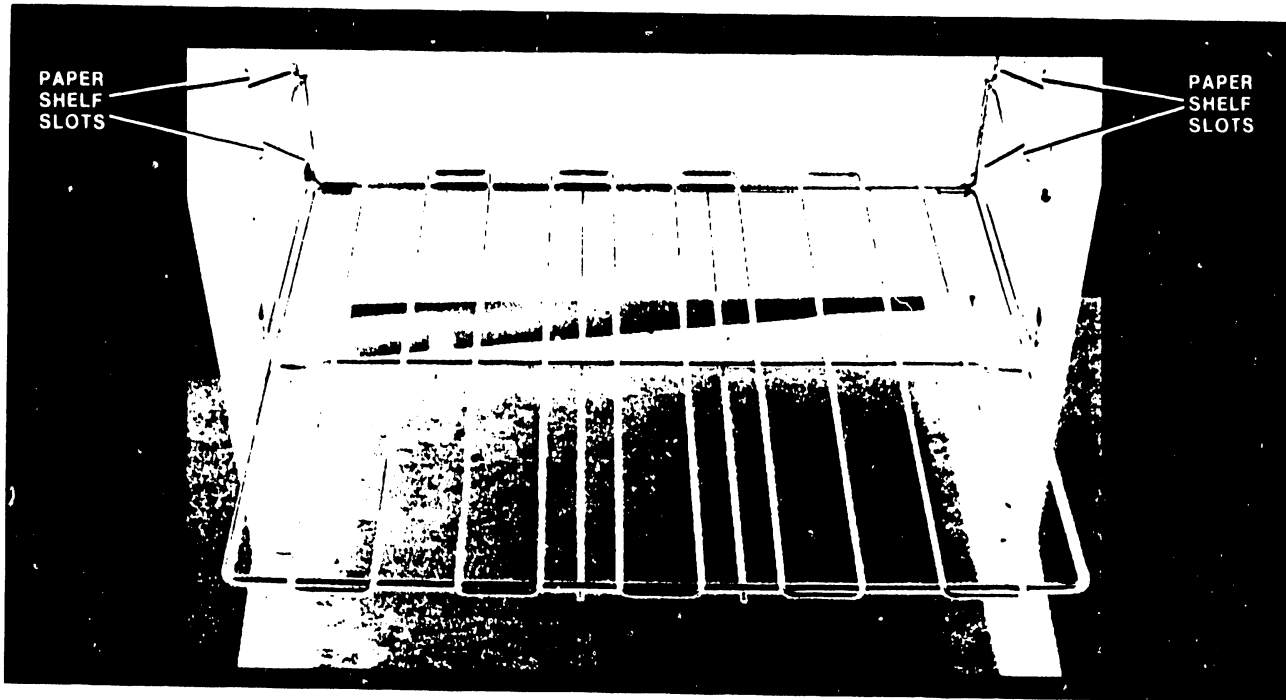

FIGURE 21
PAPER SHELF GROUND CONTACT

F. INSTALLING PAPER STATIC ELIMINATORS IN NEW SERIAL PRINTERS

1. Turn the printer ac power breaker OFF and remove the printer power plug from the ac source, after having identified the printer as a new style serial 5573 and 5574 as outlined on the first page.
2. Remove the two-5x45mm Metric hex-head cap screws, holding the printer cover, from underneath the left and right sides of the front edge of the printer base. Refer to figure 4. Then remove and set aside the cover.
3. Remove the old style PC card cage cover and save the fraction turn fasteners as instructed in Section D, steps 3 and 4. (Pages 4 and 5.)
4. Look at figure 10 to be sure the correct ground plate is installed in the printer. If it is not the correct ground plate, install a new ground plate, as shown in figure 11, after removing the terminator assembly as instructed in Section D, step 5. Reinstall the terminator assembly.
5. Install the new style PC card cage cover as instructed in Section D, steps 9 and 10. (Page 8.)
6. Be sure that the PC card cage cover is making good mechanical contact with the ground plate. It may be necessary to bend the rear plate of the PC card cage cover out to make good mechanical contact with the ground plate. Refer to figure 13.
7. Install all tinsel assemblies and springs as instructed in Section D, step 11. (Pages 9 and 10.)
8. Reroute the two cables, if not already rerouted, as instructed in Section D, step 12. (Pages 11 and 12.)
9. Reinstall the printer cover assembly.
10. Refer to Section E, Printer Pedestal and Paper Shelf Check.

PUB

CUSTOMER ENGINEERING

PUBLICATION UPDATE BULLETIN

DATE: 07/12/84

This PUB: 729-0438-A1

Class Code: 3308

Base Document: 729-0438-A

Previous Notice(s):None

REASON FOR CHANGE:

This document describes the procedure to upgrade the Wang serial Band Printer Model 5574 to 5574-1. This upgrade will allow the band printers to be used on Alliance systems.

INSTRUCTIONS:

Please insert the following pages in the rear of the Band Printer Notes document (Wang Part No. 729-0438-A).

This page is to be used as a permanent record of revisions; place it directly following the title page.



LABORATORIES, INC

ONE INDUSTRIAL AVENUE LOWELL MASSACHUSETTS 01851 TEL (617) 459 5000 TWX 710 343 6769 TELEX 94 7421

PRINTED IN U.S.A.

BAND PRINTER UPGRADE PROCEDURE

DESCRIPTION

This procedure upgrades the 5574 (600 LPM) serial band printer to 5574-1. This upgrade will allow the printers which are currently in the field to be used on Alliance systems. The procedure involves installing a 64K Siblink board and an interface card in a metal case and placing this case in an open slot in the card cage of the printer. The upgrade kit (Part No. UJ-1296 or 289-0319) contains the following parts:

<u>Quantity</u>	<u>Part No.</u>	<u>Description</u>
1	210-7780	Siblink Interface PCB
1	210-8307	Siblink PCB
1	220-3368	40 pin ribbon cable
1	220-2107	Cable assembly
1	220-2109	Power cable
1	220-2108	Jumper cable
1	452-0329	Mounting plate
1	451-2442	Cover shield
1	615-0431	Insulator
10	650-3080	6/32 x 1/4 screws
1	452-0359	Ground plate
1	615-0433	Ground wire

PROCEDURE

1. Power-off the printer.
2. Remove the cover from the printer.
3. Remove the cover over the PC boards.
4. Disconnect the three ribbon cables and the data connector cable from the Wang Interface board assembly. Figure 1 shows the cables to be removed on a late B600 printer and Figure 2 shows one of the earlier units. Note that the Wang Interface assemblies on the older and newer units are quite different.
5. Remove the Wang Interface board assembly (210-7519/7520 in late units or 210-7521 in older units).
6. Disconnect the ribbon cable from J1 on the Dataproducts Interface PCB (see Figure 1). This is the rearmost Dataproducts board in all models except those with unibus chassis where it may be in a different location. Remove the Dataproducts Interface board (Wang #726-1108 or OEM #257265-001).

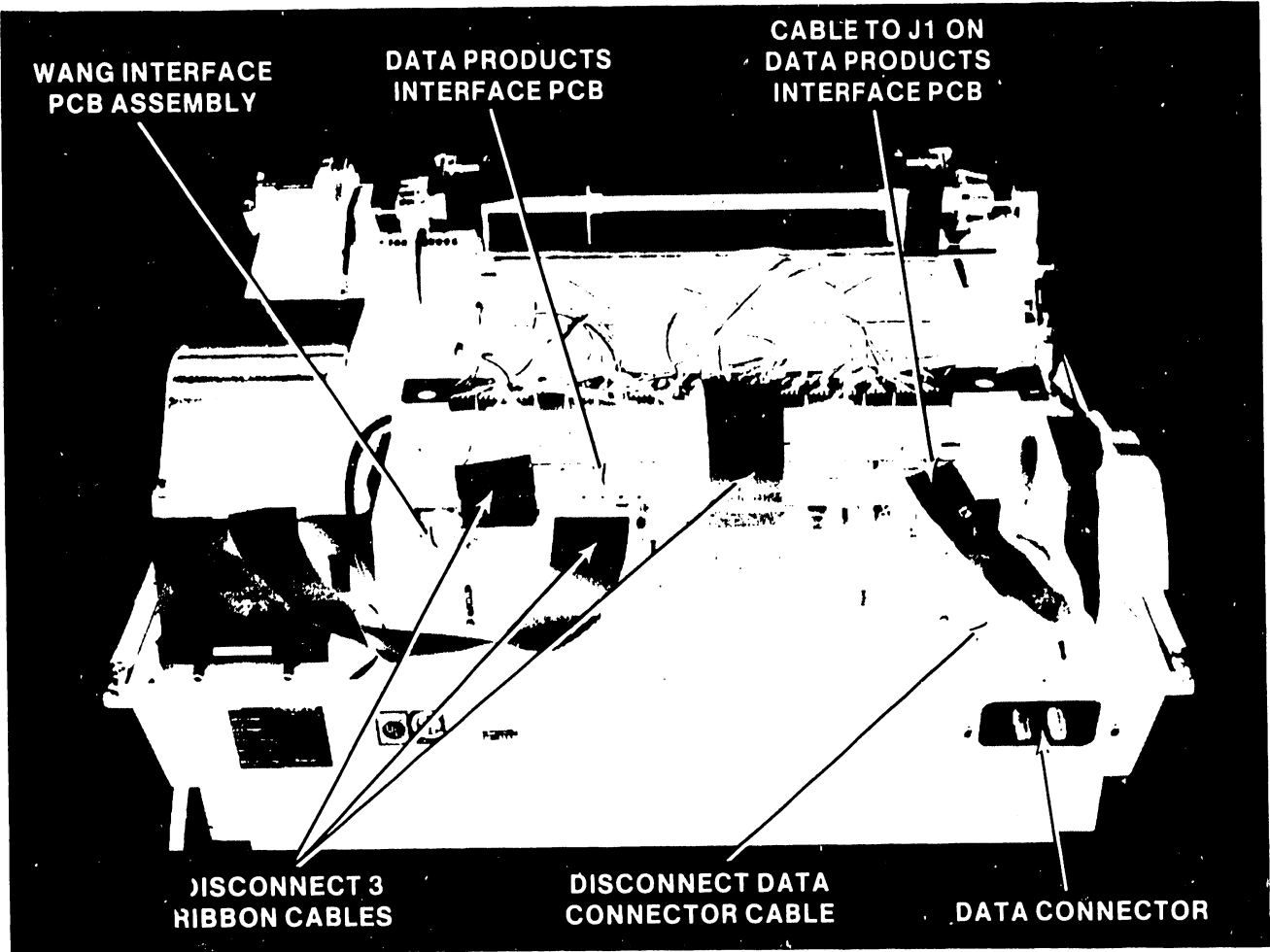

B-1094-1-094

Figure 1 Model 5574 (CB600) Printer (Before Update)

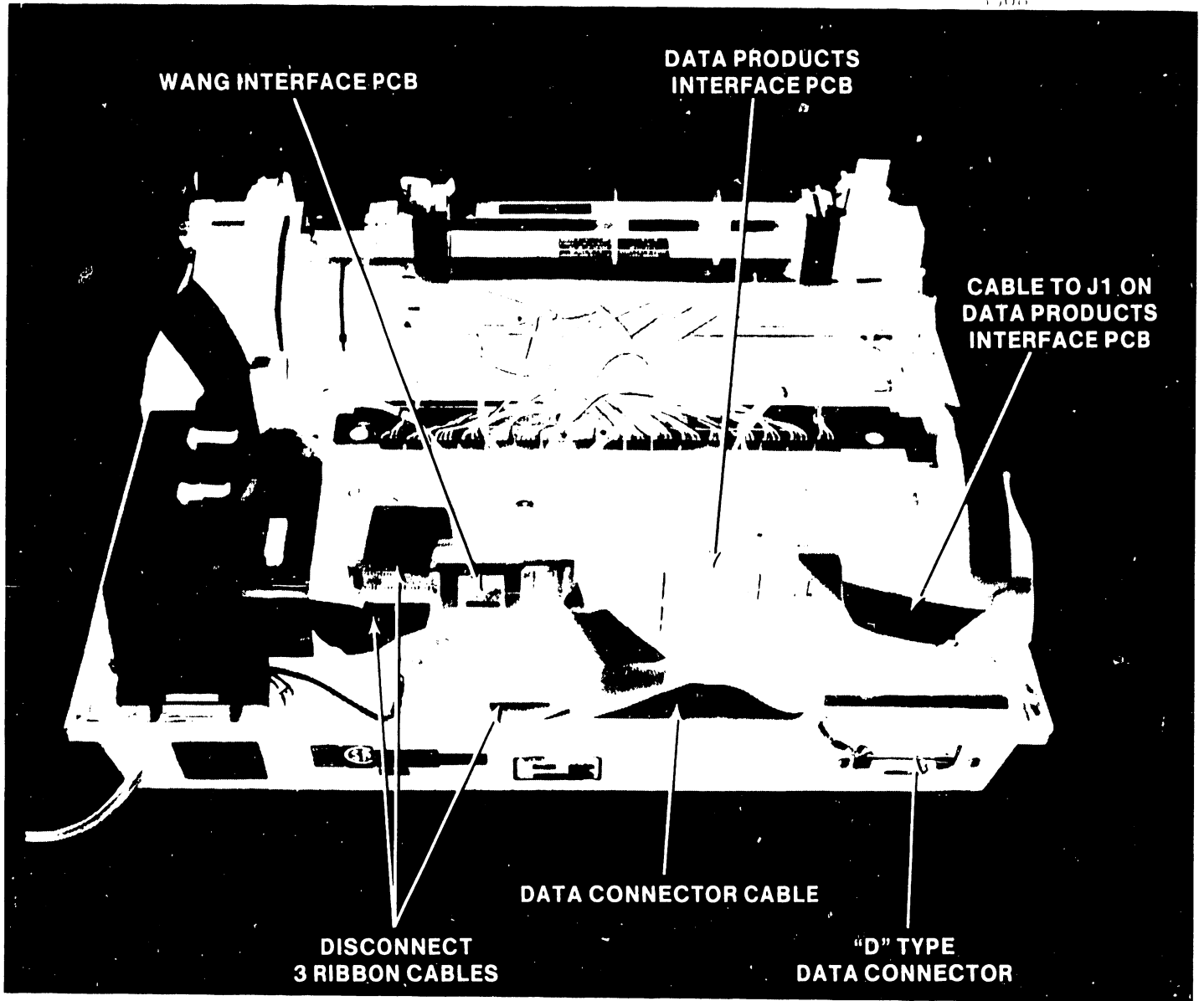

Figure 1 Model 3574 (Early 3600) Before Update

7. Solder a jumper between U20-5 and J5 pin 1 on the Interface board (see Figure 3). This jumper will not effect use of this PCB in any other serial or parallel band printer.
8. Connect the 40 position ribbon cable (#220-3368) to J5 (bottom of the Dataproducts Interface board), taking care to orient the connector so that pin 1 (red lead) is connected to the bottom pin on the left end of the connector.
9. Re-install the Interface board in the card cage.
10. Remove the data connector assembly (see Figure 1) which is located on the right side of the back of the printer and secured by two screws.
11. Install data connector cable assembly #220-2107 in place of the cable assembly removed in step 10. above.
12. Install the power cable (#220-2109) for the Siblinc Assembly as follows (refer to Figure 4):
 - a. Solder the red lead to the feed-through hole marked K +5V in the motherboard.
 - b. Solder the violet wire to the feed-through marked F -9V.
 - c. Scratch the motherboard to uncover the ground plane next to but not on test point TP-B and solder the black lead here.
13. Place the insulator sheet (#615-0431) over the four stand-offs on the mounting plate (#452-0329). Then mount the Siblinc PCB (210-8307) on the mounting plate using four 6/32 x 1/4 screws (see Figure 5).
14. Mount the Interface card (210-7780) on the cover shield (451-2442) using four screws. The mounted cards should appear as shown in Figure 5.
15. Assure that the switch banks (see Figure 5) on the Siblinc PCB are properly set for device type 0314. The correct settings are as follows:

<u>Switch Bank</u>	<u>ON (closed)</u>	<u>OFF (open)</u>
SW1 (8 bank)	4,6	All others
SW2 (8 bank)*	None	All
SW3 (4 bank)*	1,2	All others

* SW2 and SW3 may be labeled wrong on earlier version PCBs.

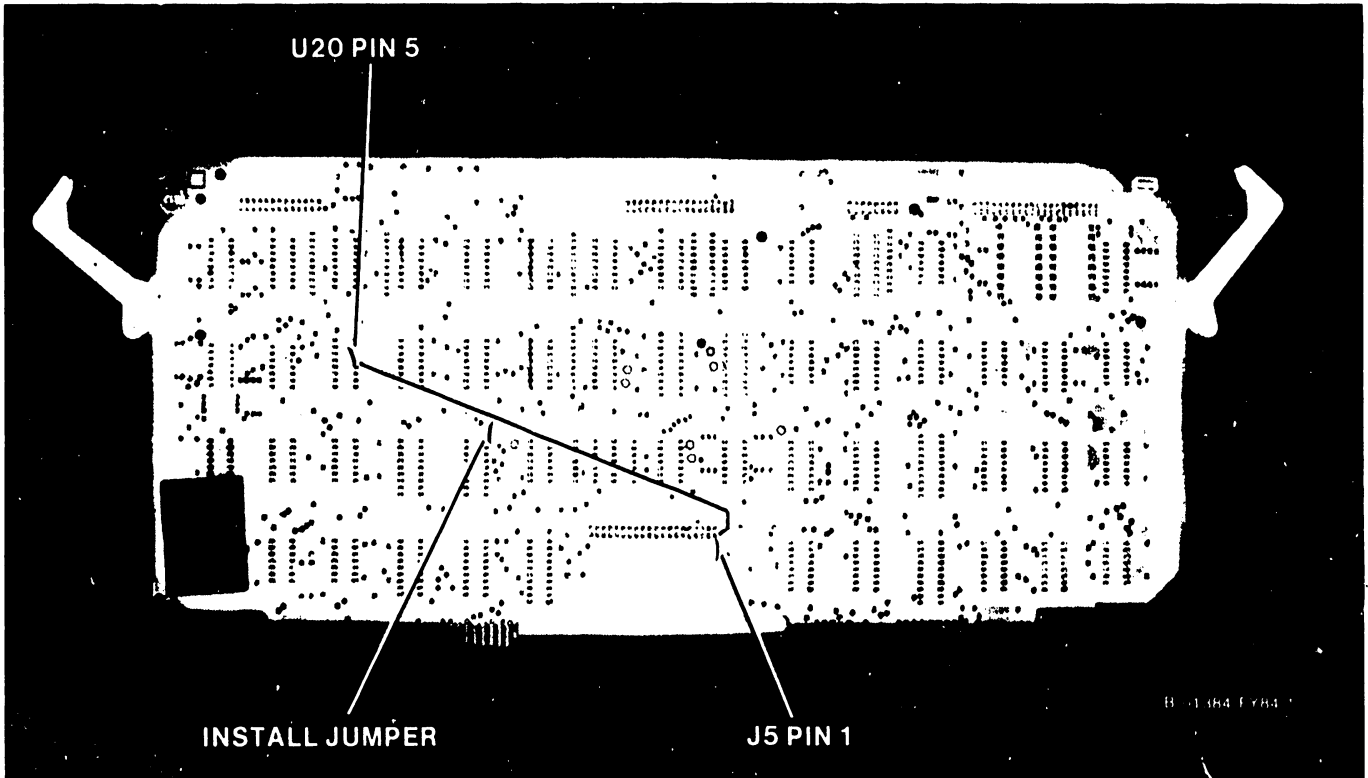

Figure 3 Jumper Installed on Dataproducts Interface Board
(Wang #726-1108 or OEM #257265-001)

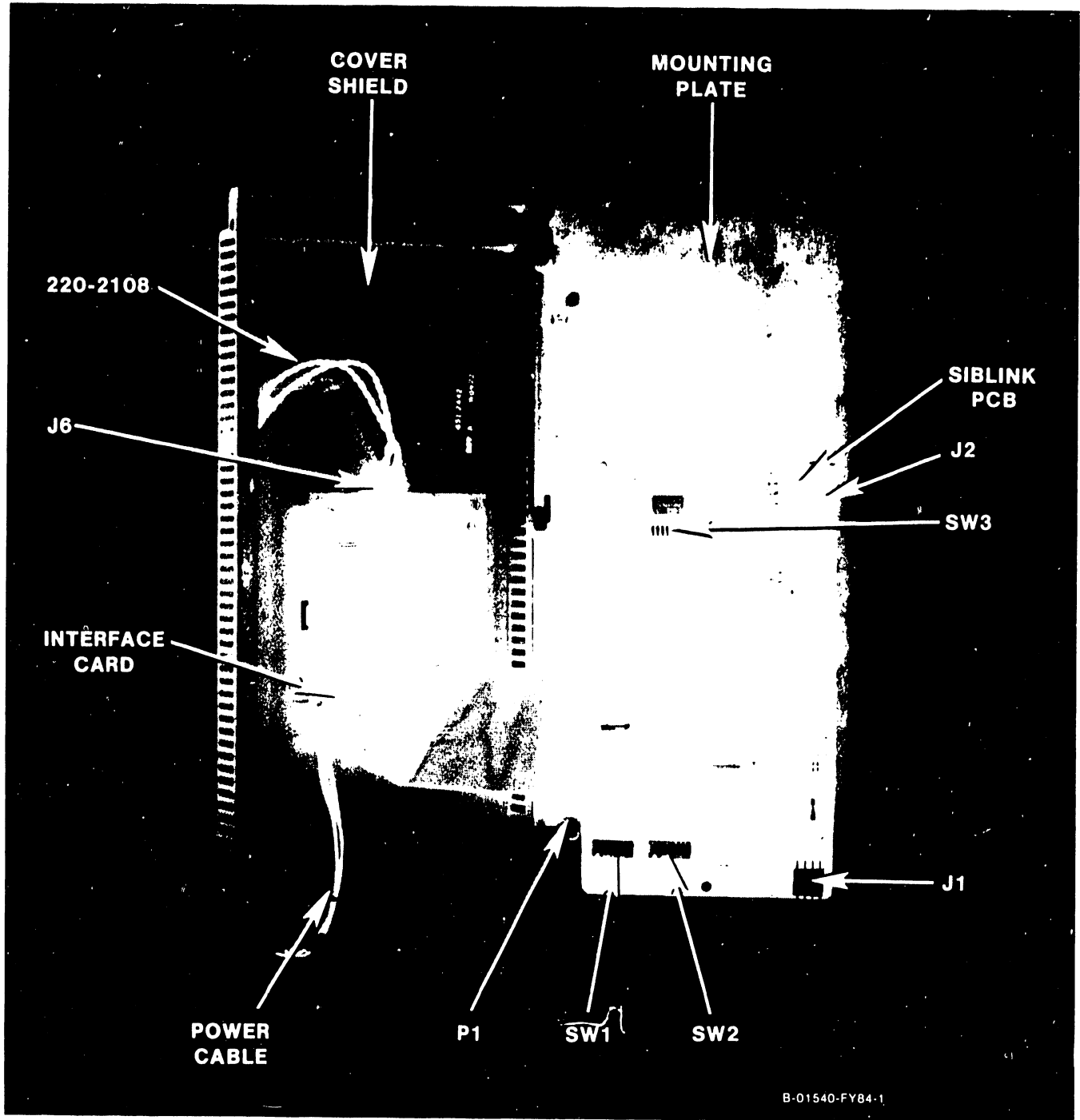

Figure 5 Sibling PCB and Interface Card Mounting

16. Connect the interconnecting cables between the Siblink and Wang Interface cards as follows (see Figure 5):
 - a. Connect the ribbon cable (which comes from J2 on the Wang Interface PCB) to P1 on the Siblink PCB.
 - b. Connect the 3 wire power cable from the Wang Interface PCB to J1 on the Siblink PCB.
 - c. Connect the jumper cable (#220-2108) between J6 on the interface card and J2 on the Siblink.
17. Assemble the metal case using the two remaining screws.
18. Partially insert the completed Siblink assembly into the rearmost card position in the printer and connect the 40 pin ribbon cable which comes from J5 on the Dataproducts Interface PCB to J1 on the Siblink Assembly (see Figure 6). Then completely insert the Siblink assembly and lock into position.
19. Connect the remaining cables to the new Siblink assembly as follows (see Figure 6):
 - a. Connect the 4 pin Molex connector to J3.
 - b. Connect the 5 pin connector to J5.
20. Connect the ribbon cable coming from the control panel to J4 on the Dataproducts interface board (see Figure 6).
21. Re-install the cover over the PC boards.
22. Re-install the printer cover.

Finally, power-on and run through a standard word processing printout procedure and the 5574-1 diagnostic to verify that the upgrade is properly installed and working correctly.

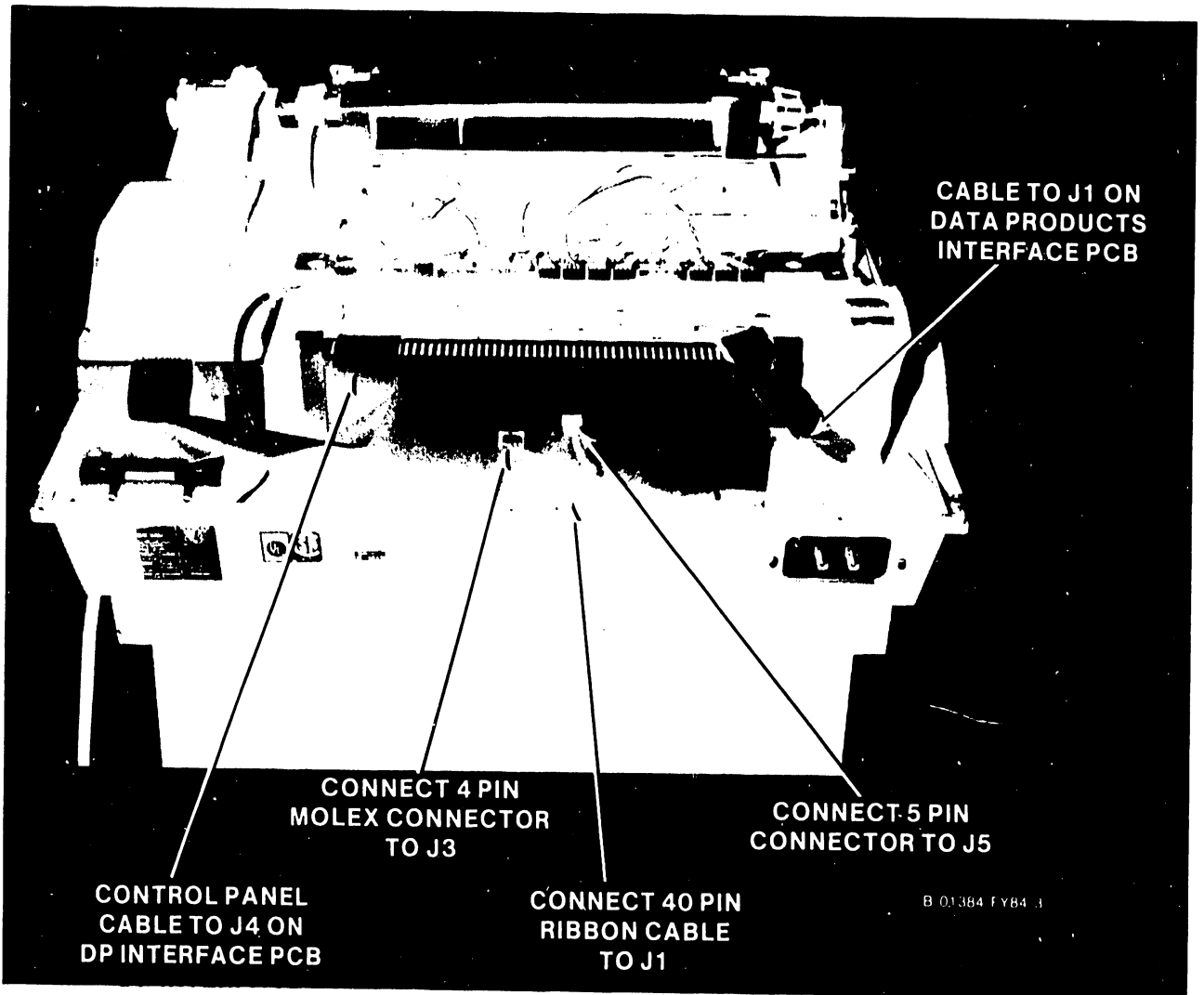

Figure 6 Upgrade Kit Installed



LABORATORIES, INC

ONE INDUSTRIAL AVENUE, LOWELL, MASSACHUSETTS 01851. TEL (617) 459-5000. TWX 710 343-6769. TELEX 94-7421

PRINTED IN U.S.A.

END