

CUSTOMER ENGINEERING

MODEL 2211M PRINTER/PLOTTER MULTIPLEXER

MAINTENANCE MANUAL

NOTICE:

This document is the property of Wang Laboratories, Inc. Information contained herein is considered company proprietary information and its use is restricted solely to the purpose of assisting you in servicing Wang products. Reproduction of all or any part of this document is prohibited without the consent of Wang Laboratories.

WANG

LABORATORIES, INC.

ONE INDUSTRIAL AVENUE, LOWELL, MASSACHUSETTS 01851, TEL. (617) 459-5000, TWX 710 343-6769, TELEX 94-7421

TABLE OF CONTENTS

SECTION 1	DESCRIPTION	1-1
1.1	GENERAL	1-1
1.2	SPECIFICATIONS	1-2
SECTION 2	UNPACKING AND INCOMING INSPECTION	2-1
SECTION 3	INITIAL SETUP	3-1
SECTION 4	THEORY OF OPERATION (BLOCK LEVEL)	4-1
4.1	GENERAL	4-1
4.2	POWER-ON	4-1
4.3	CHANNEL-SELECTION	4-1
4.4	PROTECT-DELAY	4-2
4.5	SIGNAL MNEMONICS	4-2
SECTION 5	DIAGNOSTIC TESTING PROCEDURES	5-1
5.1	PRELIMINARY CHECK	5-1
5.2	PRINTER/PLOTTER DIAGNOSTIC	5-1
SECTION 6	TROUBLESHOOTING	6-1
SECTION 7	BILL OF MATERIALS	7-1
SECTION 8	SCHEMATICS	8-1

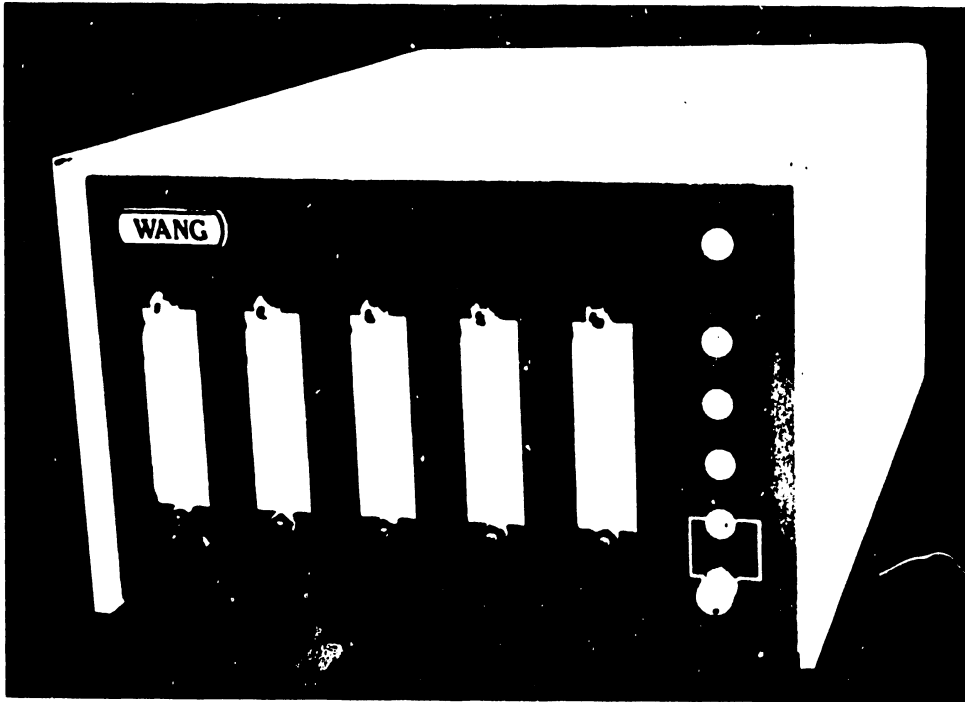

SECTION

1

**DESCRIP-
TION**

SECTION 1
DESCRIPTION

1.1 GENERAL

The Model 2211M Printer/Plotter Multiplexer is a modified version of the Model 2221M Printer/Plotter Multiplexer. The 2211M Multiplexer permits a single printer or plotter (except the Model 2212 and Model 2232A/B Flatbed Plotters) to be shared by up to four units: 2200A, B, C, S, T, VP, MVP [Central Processing Units (CPU's)]; 2200E [Portable Computing System (PCS)]; PCS2/2A; 2200F [Work Station (WS)]; and 2236D/DE Interactive Terminals.

NOTE:

Hereinafter, the units listed above will be referred to as "CP/WS", and "printer/plotter" will be represented by "P/P".

As of the date of this manual, Wang Laboratories does not sell the 2211M Multiplexer for the purpose of connecting it to a VS CPU; furthermore, the Home Office Customer Engineering Group does not support the VS/2211M configuration.

The 2211M Multiplexer is packaged in a chassis that contains the digital logic, channel indicators, channel-select switch, and power supply. Five 36-pin female connectors accept the P/P and CP/WS cables. Four 12-foot (3.7-meter) CP/WS interconnection cables are supplied with the multiplexer.

1.2 SPECIFICATIONS

Required Supply Voltage:

115 or 230 volts ($\pm 10\%$), ac, 50 or 60 hertz (± 1 hertz)

Power Consumption:

25 watts

Heat Output:

85 BTU/hr

Fuse Rating:

115 volts - 6/10 ampere, 250 volts, slow-blow (WL #360-1006SB)

230 volts - 3/10 ampere, 250 volts, slow-blow (WL #360-1003SB)

Cable Description:

Ac Power Cord - 6 ft (1.8 m)

CP/WS Inter-connection Cable - 12 ft (3.7 m) (WL #220-0105)

Operating Environment:

Temperature - 50^oF to 90^oF (10^oC to 32^oC)

Relative Humidity - 30% to 80%, non-condensing

Dimensions of Chassis:

Height - 5.5 in. (13.8 cm)

Width - 8 in. (20.0 cm)

Length - 11.5 in. (28.8 cm)

Weight - 15 lbs (6.7 kg)

SECTION

2

**UNPACKING &
INCOMING
INSPECTION**

SECTION 2
UNPACKING AND INCOMING INSPECTION

Before unpacking the unit, visually inspect the shipping container for any indications of shipping damage (crushed edges or corners, punctures, tears, etc.). If any shipping damage is found, file an appropriate claim with the carrier involved.

Open the shipping container and remove all packing material. Remove the unit from the shipping container and place the unit on a flat, sturdy surface. Once again visually inspect the unit for damage. If any shipping damage is found, file an appropriate claim with the carrier involved and notify the WL Distribution Center (Department 90), Quality Assurance Department, Tewksbury, MA. 01876, of the nature and extent of the damage, making arrangements for equipment replacement, if necessary.

Four 12-foot (3.7-meter) CP/WS interconnection cables should be included with the unit. Inspect each cable for damage.

SECTION

3

INITIAL

SETUP

SECTION 3
INITIAL SETUP

- A. Remove the six screws that secure the multiplexer cover to the chassis and then remove the cover of the unit. Inspect the unit for damaged assemblies, loose hardware and/or solder splashes.
- B. Ensure that the ac line voltage and frequency provided at the installation site is correct for the unit. (The line voltage and frequency at which the unit is set to operate is indicated on the unit serial number tag; refer to FIGURE 3-2.) Verify that the voltage-select switch (ref: FIGURE 3-3) is set properly. Verify that the multiplexer ac power ON/OFF switch is in the OFF position. The ac power cord may now be plugged in.
- C. Place the ac power switch (ref: FIGURE 3-2) to the ON position. The POWER indicator and the channel #1 (CH 1) indicator on the front panel should light.
- D. Check +5VR with a digital voltmeter (dvm). This may be done by placing the negative lead of the dvm on pin 7 of L1 and the positive lead on pin 14 of L1 (ref: FIGURE 3-4). Ensure voltage is between +4.8V and +5.2V. There is no +5VR adjustment.
- E. Place the multiplexer ac power switch to the OFF position.
- F. (Refer to FIGURE 3-1 and FIGURE 3-5.) Plug the I/O cable that is attached to the printer or plotter into the jack labeled "I/O". Using the CP/WS interconnection cables supplied (WL# 220-0105), connect the CP/WS designated #1 to the jack labeled "CH 1"; connect the #2 CP/WS to "CH 2", the #3 to "CH 3", and the #4 to "CH 4".
- G. Place the multiplexer ac power switch to the ON position and run all appropriate (printer or plotter) diagnostics on each system channel (ref: Diagnostic Testing Procedures, Section 5). After each channel has been tested, replace the cover of the unit.

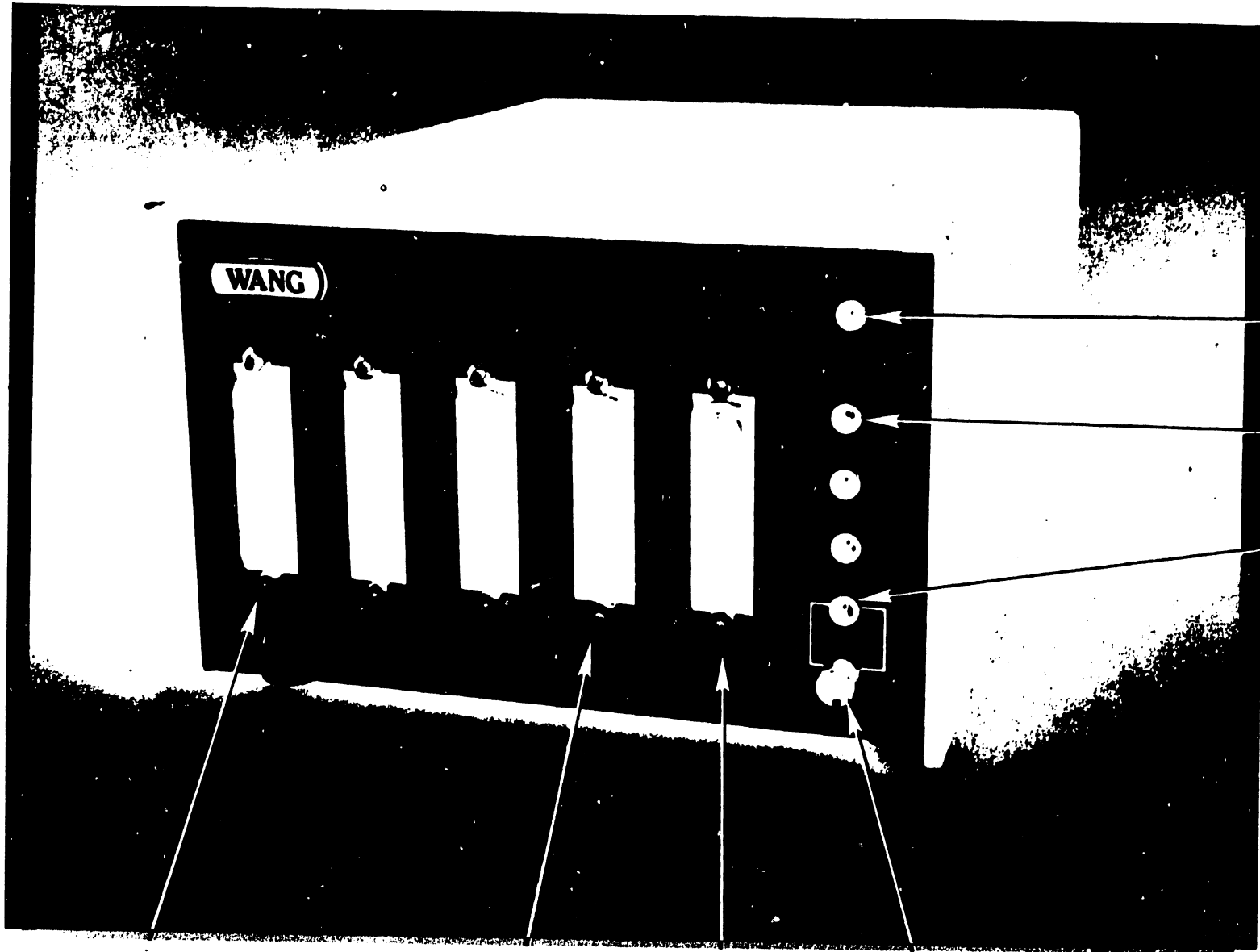

CHANNEL #1
(CPU #1)
JACK

CHANNEL #4
(CPU #4)
JACK

I/O
(PRINTER/
PLOTTER)
JACK

CHANNEL-
SELECT
SWITCH

POWER
INDICATOR

CHANNEL #1
INDICATOR

CHANNEL #4
INDICATOR

FIGURE 3-1 2211M; FRONT VIEW

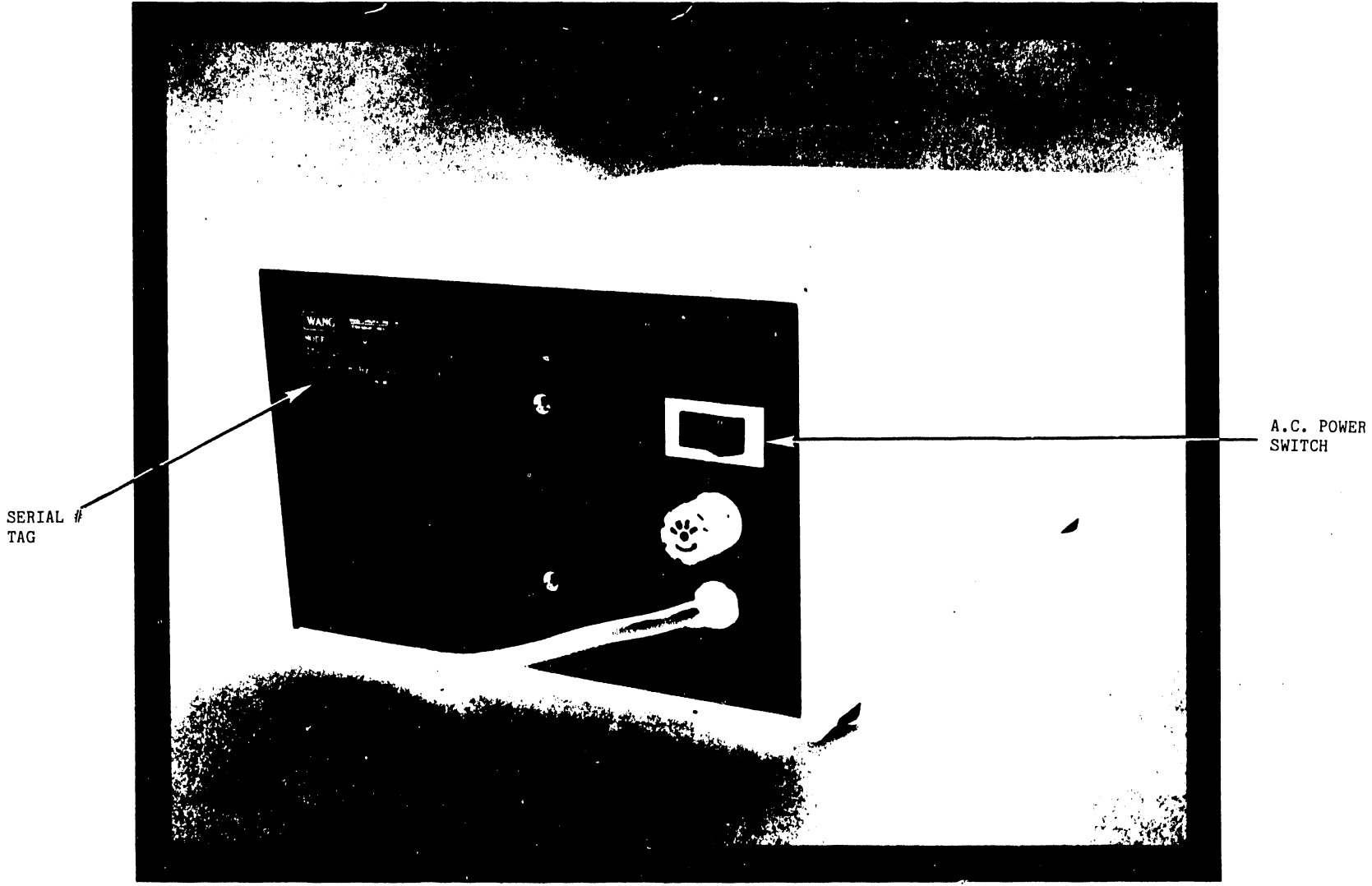

SERIAL TAG

A.C. POWER SWITCH

FIGURE 3-2 2211M; REAR VIEW

VOLTAGE-
SELECT
SWITCH

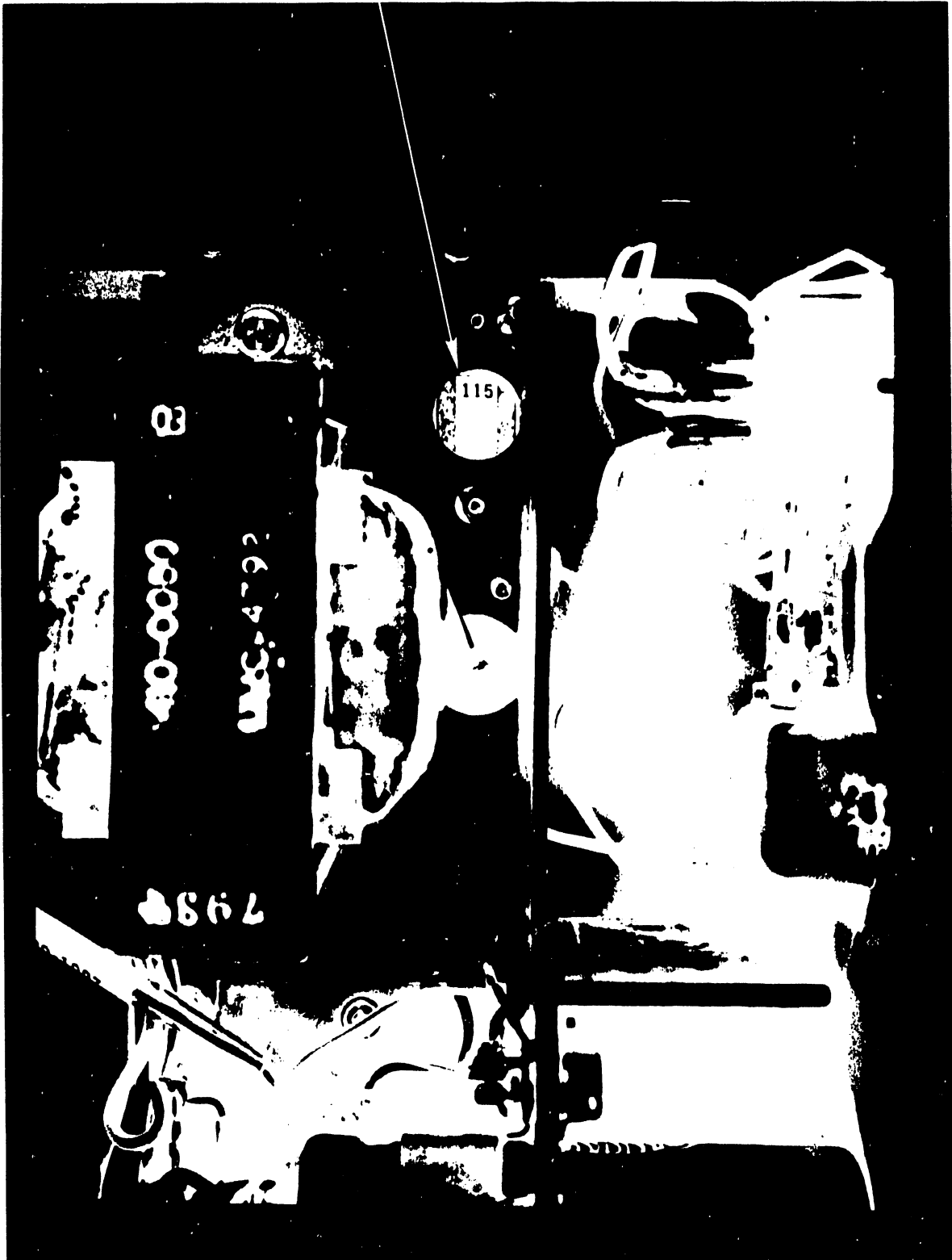

FIGURE 3-3 VOLTAGE-SELECT SWITCH

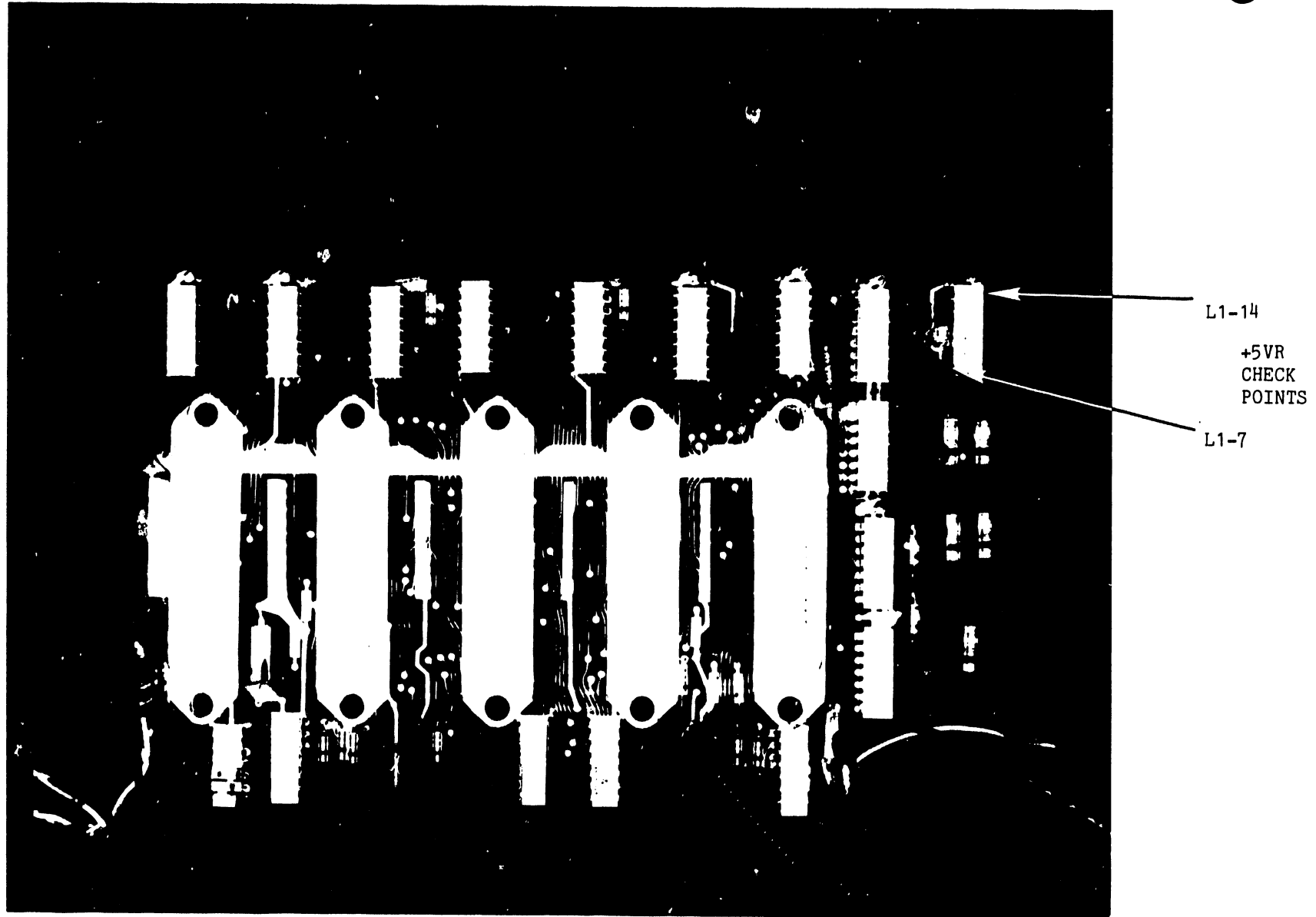
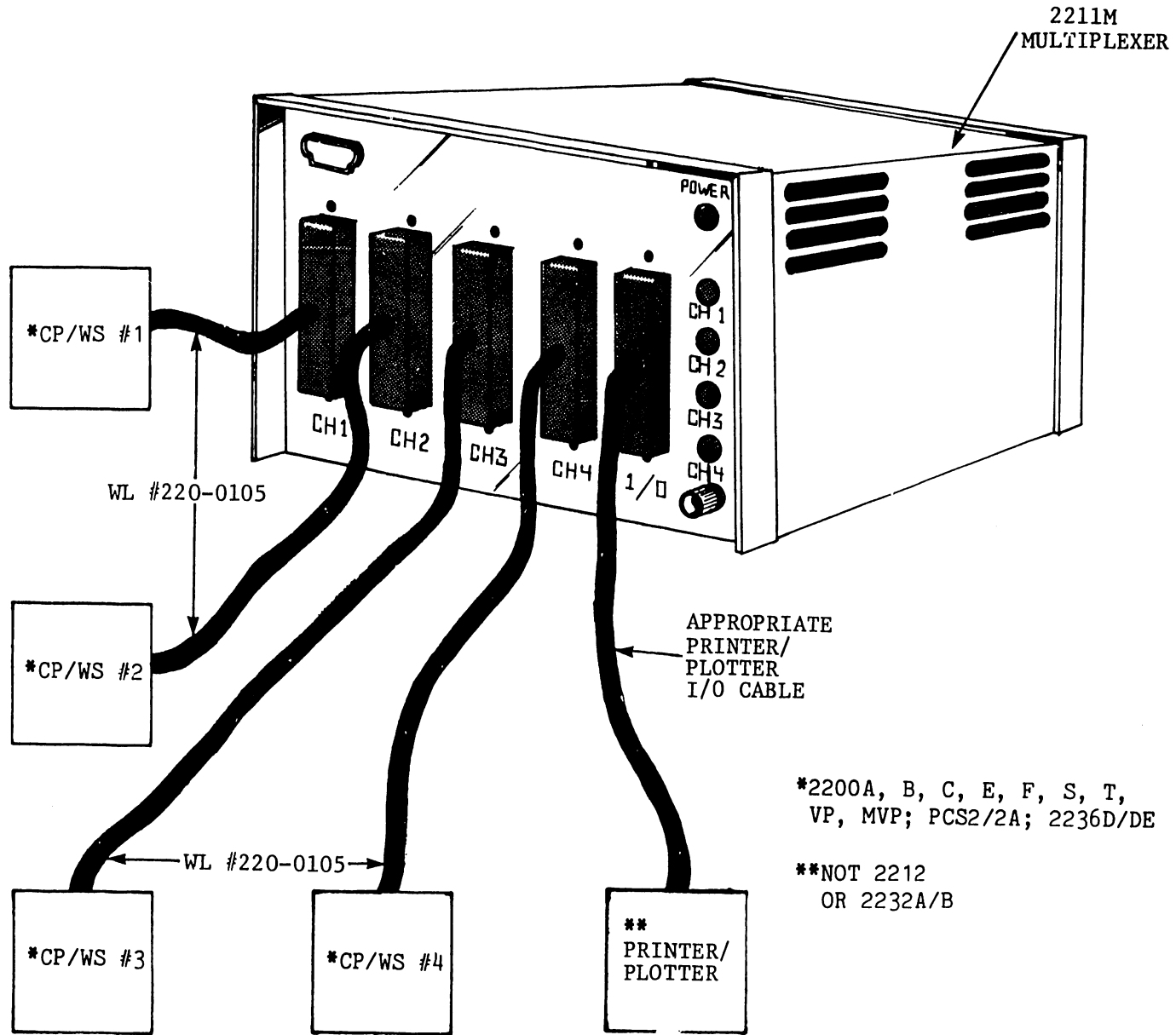

FIGURE 3-4 210-7430 PCB; +5VR CHECK POINTS



3-6

FIGURE 3-5 SYSTEM CONFIGURATION

SECTION

4

THEORY

OF

OPERA-

TIONS

SECTION 4
THEORY OF OPERATION (BLOCK LEVEL)

4.1 GENERAL

The 2211M Multiplexer controls access to the printer or plotter by means of select circuitry that is regulated by a channel-select switch. This manually operated switch determines which of the four possible CP/WS's will have exclusive access to the P/P. At power-on, the multiplexer automatically selects channel #1. Incorporated into the multiplexer electronics is a four-second channel-select delay that prevents inadvertent output from a bypassed channel while the desired channel is being selected.

4.2 POWER-ON (Reference FIGURE 4-1.)

Power-on sets the channel-selection counter (L3), which is made up of two 7473-type flip/flops wired to count from '0' to '3' in binary, to the 'clear' state (00_2). This action lights the CH 1 indicator, and channel #1 is selected for printer access. (See following Channel Selection theory.)

4.3 CHANNEL-SELECTION (Reference FIGURE 4-1.)

When the channel-select switch is depressed, the select flip/flop (L13) 'sets', and then 'resets' when the switch is released. The pulse provided by the select flip/flop output (pin 6) clocks the channel-selection counter. A count of '1' causes the LED decoder (L2) to illuminate the CH 2 indicator. At the same time, the outputs from the channel-selection counter allow the eight data bits, the data strobe bit, and the prime bit from CP/WS #2 to pass through multiplexers (L4,7,8,9,15) to the printer. The channel-selection counter outputs also allow the P/P status bits to pass through de-multiplexers (L5,6,16) to CP/WS #2.

Operation for other CP/WS channels is similar to that described above-- with a channel-selection counter output of 00_2 selecting channel #1, 10_2 selecting channel #3, and 11_2 , channel #4.

4.4 PROTECT-DELAY (Reference FIGURE 4-1.)

When the channel-select switch is depressed, the protect-delay circuitry (L17, 18) produces a 4-second pulse. This pulse disables all multiplexer and de-multiplexer outputs for that 4-second protect interval. This design feature ensures no inadvertent output from a bypassed channel while the desired channel is being selected. Four seconds after the desired channel is selected, the 2211M Multiplexer will enable the data and status lines to the P/P.

4.5 SIGNAL MNEMONICS

$\overline{\text{ACK}}$	Acknowledge from P/P; buffered acknowledge to CP/WS
BUSY	Busy status from P/P; buffered busy status to CP/WS
CLK	Clock from P/P; buffered clock to CP/WS
D1 - D8	Data lines from CP/WS; buffered data lines to P/P
$\overline{\text{DSTB}}$	Data strobe from CP/WS; buffered data strobe to P/P
FAULT	Fault status from P/P
FAULT ₁₋₄	Fault status to CP/WS
PO	Paper out status from P/P; buffered paper out status to CP/WS
PRIME	Prime line from CP/WS; buffered prime line to P/P
SL	Select line from CP/WS; buffered select line to P/P

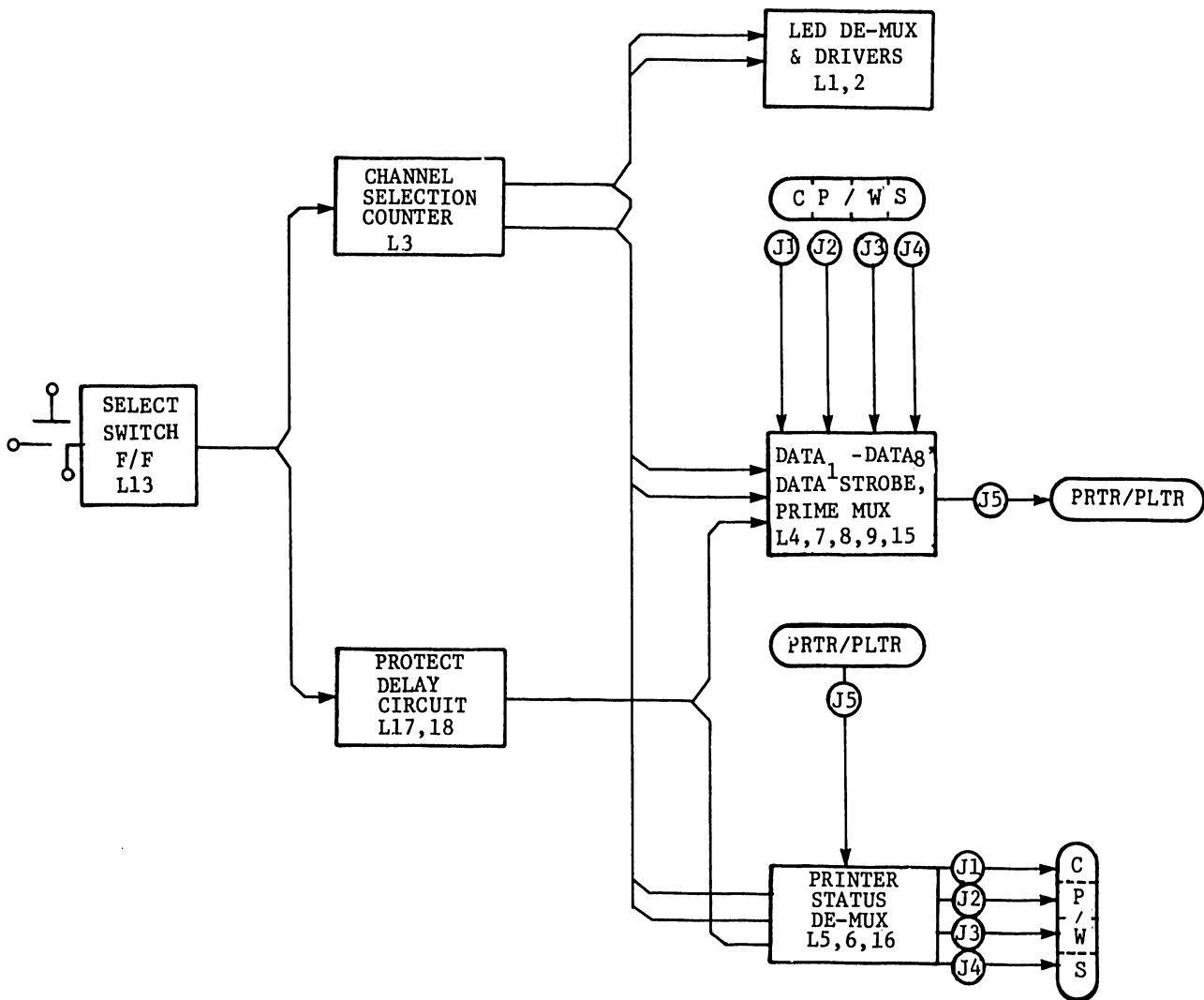

FIGURE 4-1 BLOCK DIAGRAM

SECTION

5

**DIAGNOSTIC
TESTING
PROCEDURES**

SECTION 5

DIAGNOSTIC TESTING PROCEDURES

5.1 PRELIMINARY CHECK

After power is applied and channel #1 is selected, depress the channel-select switch and the CH 2 LED should light. Depress the channel-select switch a second time; the CH 3 LED should light. Depress the channel-select switch once more; the CH 4 LED should light. Depressing the channel-select switch one final time should cause the CH 1 LED to relight, thus completing the channel-select count-sequence/cycle.

5.2 PRINTER/PLOTTER DIAGNOSTIC

A standard 2200 printer or plotter diagnostic should be run on each system channel. Reference the appropriate CP/WS manual(s) for P/P diagnostic operating procedures.

The P/P diagnostic may be run on all four system channels simultaneously. Programs in the CP/WS's that are not selected by the 2211M Multiplexer will "hang-up" when they attempt to access the P/P. When a waiting ("hung") unit is selected, the selected unit will transfer data to the P/P. (Index the channel-select switch as required.) The multiplexer will not allow CP/WS-to-P/P data transfer until four seconds have elapsed from the time the channel-select switch is depressed, thus enabling a given channel. If the channel-select switch is depressed while the P/P is operating, the output will immediately be interrupted (data may be lost), and four seconds later the new channel will transfer data to the P/P. The CP/WS that was utilizing the P/P will not display an error message; that CP/WS will "hang", attempting to access the P/P. When the interrupted channel is re-selected, that CP/WS regains access to the P/P, and transfers the next line of data to the P/P.

SECTION

6

**TROUBLE-
SHOOTING**

SECTION 6
TROUBLESHOOTING

The Single-Board Printer Exerciser (WL #190-0704) may be attached to each 2211M Multiplexer CP/WS jack to aid in troubleshooting a defective system.

SECTION

7

**BILL OF
MATER-
IALS**

SECTION 7
BILL OF MATERIALS

The 2211M Multiplexer Bill of Materials starts on the next page. At the end of this section (page 7-8), there is a photograph of the interior of the unit with all major assemblies and components pointed out.

MB0080-A MULTI-LEVEL BILL OF MATERIAL

ASSEMBLY PART NUMBER 177-2211-M - -
 ASSEMBLY DESCRIPTION 2211M PRINTER MULTIPLEXER

LEGEND
 1: P=PHANTOM; 2: ITEM MASTER DELY CODE

POSITION IN STRUCTURE	LEGEND			COMPONENT PART NUMBER	DESCRIPTION	E C N	QUANTITY PER ASSY	U/M
	1	2	3					
1		IN		187-2211-M - -	2211M PRINTER MULTIPLEXER		1.0000	EACH
2		IN		000-0005- - -	LABOR PRODUCTION SYSTEMS		2.6360	
2		IN		000-0011- - -	LABOR QUALITY CONTROL		.5270	
2		IN	*	210-7430- - -	PCA 2291 PRINTER MULTIPLEXER		1.0000	EACH
3		IN		000-0001- - -	LABOR CIRCUIT SYSTEMS		2.6420	
3		IN		000-0011- - -	LABOR QUALITY CONTROL		.5280	
3		IN		000-6011- - -	CIRCUIT SYS.-ASSY.		2.6420	EACH
3		IN		220-1294- - -	POWER CABLE 2211M	B6482-203 E11240	1.0000	EACH
4		IN		000-0004- - -	LABOR SUB-SYSTEMS		.2500	EACH
4		IN		000-0011- - -	LABOR QUALITY CONTROL		.0500	
4		IN		000-6043- - -	SUB-SYS.-CABLES		.2500	EACH
4		P FS		600-1000- - -	WIRE 22 GA BLACK		.4600	FEET
5		FS		600-1009- - -	WIRE 22 GA WHITE		1.0000	FEET
4		P FS		600-1002- - -	WIRE 22 GA RED		.4600	FEET
5		FS		600-1009- - -	WIRE 22 GA WHITE		1.0000	FEET
4		FS		605-0014- - -	TUBING #5 CLEAR		.2900	FEET
4		IN		606-1294- - -	3/8" DIA WHT SHRINK BLK NU 220-1294	E11840	1.0000	EACH
4		IN		654-1147- - -	PIN HOUSING 1-480319-0		1.0000	EACH
4		FS		654-1166-R - -	PIN TERM 30-22 GA (REEL) AMP3500079-4		2.0000	EACH
3		IN		220-1295- - -	POWER CABLE TO BD	B6482-460 E11240	1.0000	EACH
4		IN		000-0004- - -	LABOR SUB-SYSTEMS		.1600	EACH
4		IN		000-0011- - -	LABOR QUALITY CONTROL		.0320	
4		IN		000-6043- - -	SUB-SYS.-CABLES		.1600	EACH
4		P FS		600-2000- - -	WIRE 24 GA BLACK UL		.2500	FEET
5		FS		600-2009- - -	WIRE 24 GA WHITE UL		1.0000	FEET
4		P FS		600-2004- - -	WIRE 24 GA YELLOW UL		.2500	FEET
5		FS		600-2009- - -	WIRE 24 GA WHITE UL		1.0000	FEET

7-2

4	P	FS	600-2005-	- -	WIRE 24 GA GREEN UL	W/OFF-76	.2500	FEET
5		FS	600-2009-	- -	WIRE 24 GA WHITE UL		1.0000	FEET
4		IN	654-1149-	- -	PIN HOUSING 1-480305-0		1.0000	EACH
4		FS	654-1166-R	- -	PIN TERM 30-22 GA(REEL)AMP3500079-4		3.0000	EACH
2		IN	220-0105-	- -	2221 PRINTER CABLE C6422-129	E12925	4.0000	EACH
3		IN	000-0004-	- -	LABOR SUB-SYSTEMS		.7290	EACH
3		IN	000-0011-	- -	LABOR QUALITY CONTROL		.1460	
3		IN	000-6043-	- -	SUB-SYS.-CABLES		.5000	EACH
3		IN	350-2082-	- -	CONN 18-36 CABLE TO PANEL PLUG	EC6407	2.0000	EACH
3		IN	350-4233-G	- -	STRAIN RELIEF CVR 36 POS 180DEG GRV	EC8484	2.0000	EACH
3		IN	350-4233-T	- -	STRAIN RELIEF CVR 36 POS 180DEG TNG	EC8484	2.0000	EACH
3		IN	350-4234-	- -	4-40X3/8 CAPT SCR FOR SCR MT CONNS.	EC6407	4.0000	EACH
3		FS	420-0058-	- -	18 TWISTED PAIR 26 GA SHIELDED CABLE	EC6407	13.0000	FEET
3		IN	458-0361-	- -	GROUND STRAP C6815-28	EC6407	2.0000	EACH
3		FS	606-0105-	- -	CBL MARKER WH/BK 2221 220-0105	EC9699	1.0000	EACH
4		FS	605-0139-	- -	TUBING 1/2 WH SHRINK POLYOLEFIN		.1140	FEET
3		IN	615-1297-	- -	LABEL PRINTER CABLE CONN A53001072	EC5402	2.0000	EACH
2		IN *	270-0316-	- -	2211M CHASSIS ASSY		1.0000	EACH
3		IN	000-0004-	- -	LABOR SUB-SYSTEMS		1.1500	EACH
3		IN	000-0011-	- -	LABOR QUALITY CONTROL		.2300	
3		IN	000-6041-	- -	SUB-SYS.-CHASSIS		1.1500	EACH
3		IN	220-1296-	- -	POWER CABLE SWITCH	B6482-461 E11240	1.0000	EACH
4		IN	000-0004-	- -	LABOR SUB-SYSTEMS		.0200	EACH
4		IN	000-0011-	- -	LABOR QUALITY CONTROL		.0040	
4		IN	000-6043-	- -	SUB-SYS.-CABLES		.0200	EACH
4	P	FS	600-2000-	- -	WIRE 24 GA BLACK UL		.2500	FEET
5		FS	600-2009-	- -	WIRE 24 GA WHITE UL		1.0000	FEET
4	P	FS	600-2004-	- -	WIRE 24 GA YELLOW UL		.2500	FEET
5		FS	600-2009-	- -	WIRE 24 GA WHITE UL		1.0000	FEET

4	P	FS	600-2005-	- -	WIRE 24 GA GREEN UL	W/OFF-76	.2500	FEET
5		FS	600-2009-	- -	WIRE 24 GA WHITE UL		1.0000	FEET
4		IN	654-1150-	- -	SOCKET HOUSING 1-480303-0		1.0000	EACH
4		FS	654-1165-R	- -	SOCKET 30-22 GA (REEL) AMP 350078-4		3.0000	EACH
3	P	IN	270-0584-	- -	2224/2211M MULTI PWR SUPPLY ASSY	E11739	1.0000	EACH
4		IN	000-0004-	- -	LABOR SUB-SYSTEMS		2.0000	EACH
4		IN	000-0011-	- -	LABOR QUALITY CONTROL		.4000	
4		IN	210-6281-	- -	6281 MODULE	W/OFF/79	1.0000	EACH
5		IN	000-0001-	- -	LABOR CIRCUIT SYSTEMS		.0900	
5		IN	000-0011-	- -	LABOR QUALITY CONTROL		.0180	
5		IN	000-6011-	- -	CIRCUIT SYS.-ASSY.		.0900	EACH
5		IN	300-1901-	- -	CAP .1 UF 20% 12 V CERAMIC DISC		1.0000	EACH
5		IN	300-1902-	- -	.22 UF 20% CERAMIC CAP.		1.0000	EACH
5		IN	331-0027-	- -	RES 2.7 OHM 1/2W 10% FIXED COMP		1.0000	EACH
6		FS	331-0027-R	- -	RES 2.7 OHM 1/2W 10% FIXD COMP T&R		1.0000	EACH
5		IN	510-6281-	- -	6281 PRINTED CIRCUIT BOARD		1.0000	EACH
4		IN	220-1349-	- -	PCS II 12 VOLT CABLE	B6482-157 E13074	1.0000	EACH
5		IN	000-0004-	- -	LABOR SUB-SYSTEMS		.0930	EACH
5		IN	000-0011-	- -	LABOR QUALITY CONTROL		.0190	
5		IN	000-6043-	- -	SUB-SYS.-CABLES		.0930	EACH
5	P	FS	600-1000-	- -	WIRE 22 GA BLACK		.3300	FEET
6		FS	600-1009-	- -	WIRE 22 GA WHITE		1.0000	FEET
5	P	FS	600-1002-	- -	WIRE 22 GA RED		.3300	FEET
6		FS	600-1009-	- -	WIRE 22 GA WHITE		1.0000	FEET
5		FS	605-0014-	- -	TUBING #5 CLEAR		.2200	FEET
5		IN	654-1148-	- -	SOCKET HOUSING 1-480318-0		1.0000	EACH
5		FS	654-1165-R	- -	SOCKET 30-22 GA (REEL) AMP 350078-4		2.0000	EACH
4		IN	300-3075-	- -	14K UF 12V ELECT.CAP(SCREW TYPE)		1.0000	EACH
4		IN	300-9009-	- -	CAP CLAMP 1 1/4 INCH 2 LUG CMC-22		1.0000	EACH
4		IN	310-0005-	- -	5 TERMINAL STRIP		1.0000	EACH
4		IN	325-2112-	- -	SLIDE SW.115/230 VAC		1.0000	EACH
4		IN	331-4010-	- -	RES 10K OHM 1/2W 10% FIXED COMP		1.0000	EACH
5		FS	331-4010-R	- -	RES 10K OHM 1/2W 10% FIXD COMP T&R		1.0000	EACH
4		IN	374-0001-	- -	IC REG UA 7805 +5V TO-220		1.0000	EACH

4	IN	375-1030-	- -	2N5956 TRANSISTOR	1.0000	EACH
4	IN	375-9015-	- -	INSULATOR XTOR MOUNT WECKESSER TM-2	1.0000	EACH
4	IN	375-9019-	- -	MICA WSHR (SMALL) FOR POWER X1STORS	1.0000	EACH
4	IN	380-3002-	- -	DIO 1N4719 50V 3A RECT S C60	2.0000	EACH
4	IN	410-0080-	- -	MMC 4792 TRANSFORMER (723/724)	1.0000	EACH
4	IN	451-4186-	- -	723/724 PWR SUPPLY BRKT C6466-29	1.0000	EACH
4	IN	510-6749-	- -	6749 PRINTED CIRCUIT BOARD	1.0000	EACH
4	P FS	600-0094-	- -	18 GA WIRE WH/YELLOW	.2920	FEET
5	FS	600-0009-	- -	WIRE 18 GA WHITE UL	1.0000	FEET
4	P FS	600-2000-	- -	WIRE 24 GA BLACK UL	.5000	FEET
5	FS	600-2009-	- -	WIRE 24 GA WHITE UL	1.0000	FEET
4	P FS	600-2001-	- -	WIRE 24 GA BROWN UL	.2500	FEET
5	FS	600-2009-	- -	WIRE 24 GA WHITE UL	1.0000	FEET
4	P FS	600-2002-	- -	WIRE 24 GA RED UL	.6200	FEET
5	FS	600-2009-	- -	WIRE 24 GA WHITE UL	1.0000	FEET
4	P FS	600-2091-	- -	WIRE 24 GA WH/BRN UL	.2500	FEET
5	FS	600-2009-	- -	WIRE 24 GA WHITE UL	1.0000	FEET
4	P FS	600-2094-	- -	WIRE 24 GA WH/YEL UL	.5420	FEET
5	FS	600-2009-	- -	WIRE 24 GA WHITE UL	1.0000	FEET
4	IN	650-2087-	- -	4-40X1/4 PAN HD PHL MS SS MAG. SEMS	2.0000	EACH
4	IN	650-2120-	- -	4-40 X 3/8 PAN HD PHL MS SS SEMS	2.0000	EACH
4	IN	650-3131-	- -	6-32 X 3/8 NYLON COVERED FIL HD SLT	1.0000	EACH
4	IN	650-3160-	- -	6-32 X 1/2 PAN HD PHL MS SS SEMS	3.0000	EACH
4	IN	650-4120-	- -	8-32 X 3/8 PAN HD PHL MS SS SEMS	2.0000	EACH
4	IN	651-0405-	- -	3/16 X 3/8 POP RIVET	2.0000	EACH
4	IN	652-2005-	- -	4-40 LOCK-NUT KEPS SS	2.0000	EACH
4	IN	652-3004-	- -	NUT 6-32UNC HEX SMALL PAT SS	3.0000	EACH
4	IN	653-2000-	- -	NO. 4 FLAT WASHER	2.0000	EACH
4	IN	653-3000-	- -	WASH 6 .149ID .3750D .016 FL SS	2.0000	EACH
4	IN	653-3001-	- -	WASH 6 .150ID .2880D INT T ST	2.0000	EACH
4	IN	654-1006-	- -	#6 GROUND LUG	1.0000	EACH
4	IN	654-1010-	- -	#10 GROUND LUG	2.0000	EACH
4	IN	654-1201-	- -	GROMMET 1/4 ID FOR 3/8 HOLE	1.0000	EACH

7-6

3	IN	279-0300-	- -	MICRO SWITCH ASSY.C6060-203	E11240	1.0000	EACH
4	IN	000-0011-	- -	LABOR QUALITY CONTROL		.0040	
4	IN	000-0024-	- -	LABOR PREP AREA		.0180	EACH
4	IN	279-0301-	- -	PLUNGER GUIDE ASSEMBLY 6815-51	EC6269	1.0000	EACH
5	IN	000-0011-	- -	LABOR QUALITY CONTROL		.0010	
5	IN	000-0024-	- -	LABOR PREP AREA		.0050	EACH
5	IN	451-4066-	- -	301 MICRO-SW BRACKET C5933-116	(2	1.0000	EACH
5	IN	478-0068-	- -	301 PLUNGER GUIDE B5933-117	(2	1.0000	EACH
4	IN	325-2305-	- -	11SM1 MICRO SWITCH FOR CP-1		1.0000	EACH
4	IN	461-3056-	- -	301 SWITCH PLUNGER B5933-114		1.0000	EACH
4	IN	651-0416-	- -	301 RIVET B5933-130		2.0000	EACH
3	IN	325-0021-	- -	SWITCH, ROCKER SPST		1.0000	EACH
3	IN	325-9035-	- -	PUSH BUTTON BLACK ALCO #C12	E11681	1.0000	EACH
3	IN	360-0000-	- -	FUSE HOLDER 90 DEGREE CONTACT		1.0000	EACH
3	IN	360-9000-	- -	RUBBER WSHR FOR 360-0000 / 360-0001		1.0000	EACH
3	IN	360-9002-	- -	HEX NUT FOR 360-0000 / 360-0001		1.0000	EACH
3	IN	360-9003-	- -	LOCK WSHR LF#905023(FOR 360-0000/1)		1.0000	EACH
3	IN	370-1055-	- -	LAMP HOLDER 2 PIECE FOR 370-0026	E12543	1.0000	EACH
3	IN	370-1056-	- -	LAMP HOLDER 2 PIECE FOR 370-0027	E12543	4.0000	EACH
3	IN	410-2001-	- -	LINE FILTER, 2 AMP 2B2		1.0000	EACH
3	IN	420-1096-	- -	POWER CORD, 10 FT 18AWG	E11240	1.0000	EACH
3	IN	451-1128-	- -	CHASSIS, FAB	6618-1	1.0000	EACH
3	P FS	600-0000-	- -	WIRE 18 GA BLACK UL	E11681	.6670	FEET
3	FS	605-0010-	- -	TUBING PVC #8 CLEAR	E11681	.3120	FEET
3	FS	605-0014-	- -	TUBING #5 CLEAR	E11681	.0620	FEET
3	FS	605-1004-	- -	CABLE TYE, PAN-TY PLTIM-M	E11681	1.0000	EACH
3	IN	650-3120-	- -	6-32 X 3/8 PAN HD PHL MS SS SEMS		4.0000	EACH
3	IN	651-0405-	- -	3/16 X 3/8 POP RIVET		4.0000	EACH
3	IN	652-0003-	- -	1/4-40 HEX NUT	E11240	1.0000	EACH
3	IN	652-0032-	- -	6-32 LOCK-NUT KEPS 511-061800-00	E11802	2.0000	EACH
3	IN	652-0061-	- -	DRESS NUT 1/4-20 CHROME C&K A7099	E11240	1.0000	EACH
3	IN	652-3004-	- -	NUT 6-32UNC HEX SMALL PAT	SS E11240	1.0000	EACH
3	IN	653-3000-	- -	WASH 6 .149ID .3750D .016 FL	SS E11681	1.0000	EACH
3	IN	653-3003-	- -	WASH 6 .141ID .2530D SPLIT	SS E11240	1.0000	EACH
3	IN	653-6009-	- -	WASH 1/4 .267ID .4780D INT T	ST E11962	1.0000	EACH
3	IN	654-1006-	- -	#6 GROUND LUG		1.0000	EACH
3	IN	654-1238-	- -	HEYCO STRAIN RELIEF SR5P-4		1.0000	EACH
3	IN	655-0202-	- -	FEET WH LG WITH WSHR REC 2084 W		4.0000	EACH

2	IN	360-1006-SB- -	FUSE	6/10 AMP 250V SB GLASS	3AG E11763	1.0000	EACH
2	IN	450-0904- - -	WANG NAME TAG	C6815-97		1.0000	EACH
2	IN	451-2049- - -	703 COVER ASSY	D6100-6		1.0000	EACH
2	IN	462-0411- - -	SPACFR PTR MLTPLXR	B6647-110		10.0000	EACH
2	IN	615-1073- - -	UNIVERSAL ID LABEL(LARGE)	C5300-1066		1.0000	EACH
2	IN	650-3125- - -	6-32X3/8 FL HD PHL MS	PARKERIZE		6.0000	EACH
2	IN	652-6000- - -	NUT	10-32UNC HEX REG PAT	SS	10.0000	EACH
2	IN	653-0001- - -	WASH	19 .196ID .3750D .062 FL	NYL	10.0000	EACH

7-8

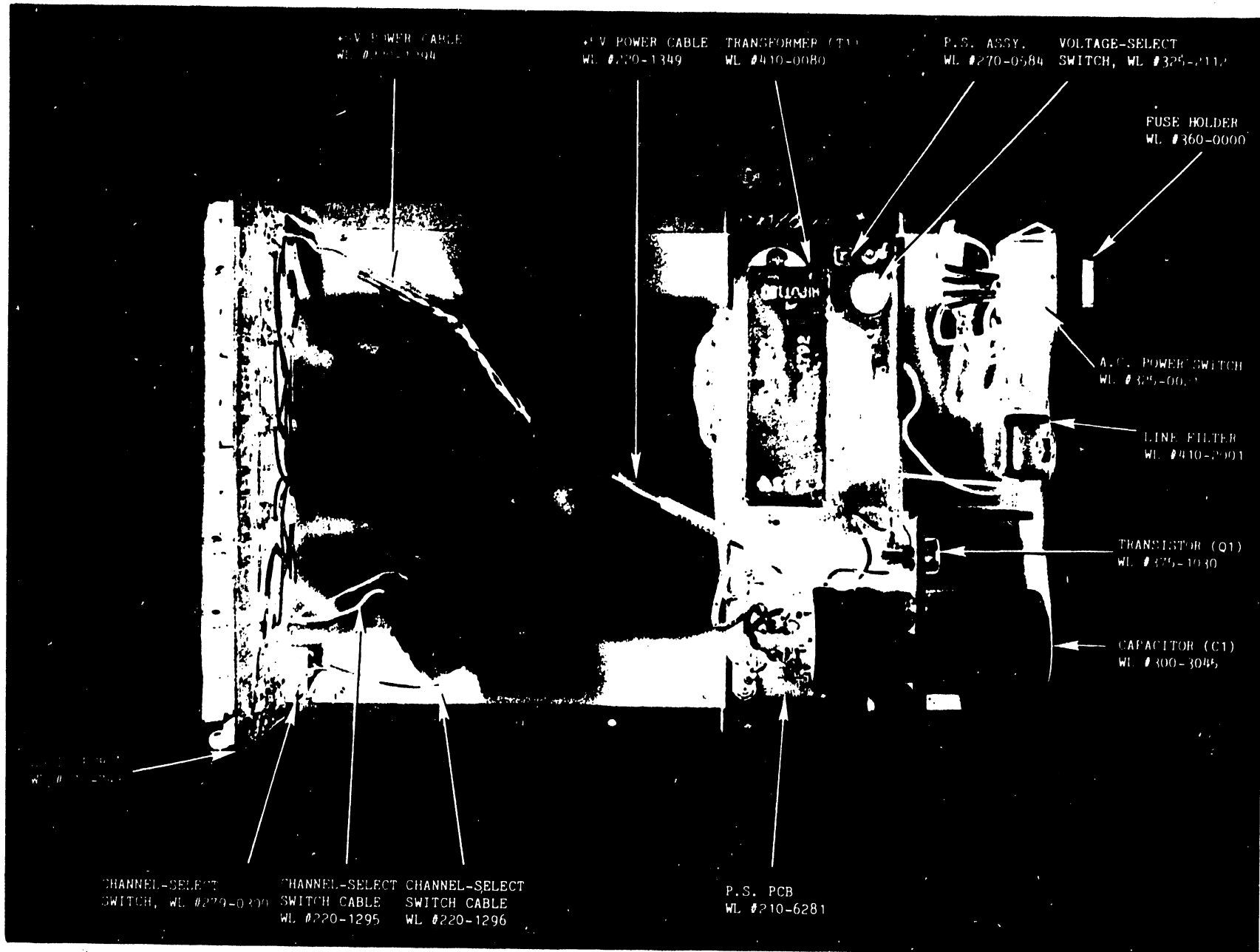

FIGURE 7-1 MAJOR ASSEMBLIES & COMPONENTS

SECTION

8

SCHE-

MATICS

SECTION 8
SCHEMATICS

The following schematics are contained in this section:

<u>Description</u>	<u>Drawing #</u>
2211M Power Supply	C6281-1
210-7430 Electronics	D7430

THIS DOCUMENT IS THE PROPERTY OF WANG LABORATORIES, INC. AND SHALL NOT BE PRODUCED OR COPIED, OR USED AS A BASIS FOR THE MANUFACTURE OR SALE OF THIS OR DEVICES WITHOUT PERMISSION.

HOLE LEGEND		
DRAILED OR	HOLE DIA.	TOL.
PUNCHED HOLE	.0425 to .125	±.002
TOLERANCES:	.126 to .250	±.002
	.251 to .500	±.002
IDENT.	DESCRIPTION	QTY.
A		

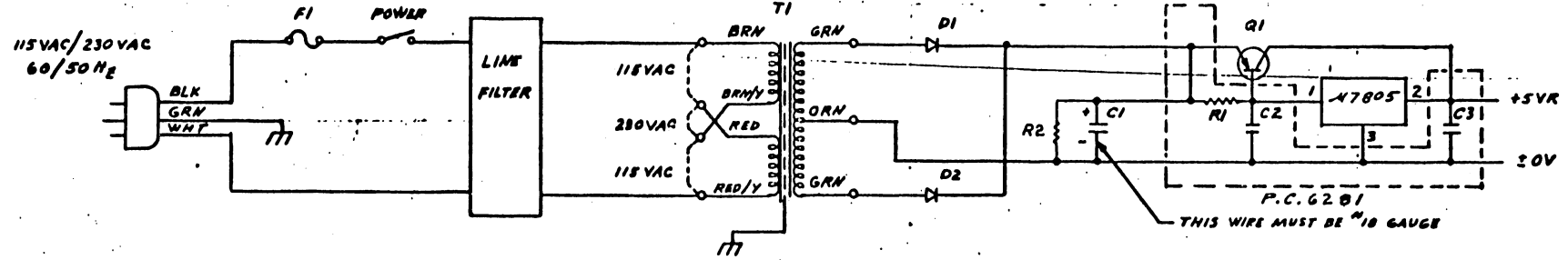

TOP VIEW

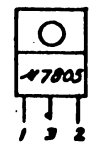

COMP	SIZE/TYPE	W.L. PART NO	QTY
R1	2.7Ω 1/2W	331-0027	1
C1	10K MF 15V	300-3045	REF
C2	.22 MF CER	300-1902	1
C3	.1 MF CER	300-1901	1
D1, 2	1N4719	380-3002	REF
Q1	40831	375-1030	REF
T1	MMC472	410-0080	REF
	47805	374-0001	REF
F1	.6A	360-1006	REF
LINE FILTER	2AMP	910-2001	REF
R2	10K 1/2W	331-4010	REF

REV	DATE	BY	DESCRIPTION
1	8-3-73	JK	PER ECH 577C REMOVED GRN FROM FILTER APP'D. SKD
2	8-3-73	JK	PER ECH 33690 R1 WAS 10W APP'D. SKH
3	11-16-73	JK	REMOVED PER RFA 0671 APP'D. SKH
4	11-1-74	JK	REVISED PER ECH 4393 APP'D. SKH

WANG PART NO	ITEM	QTY	NAME	MATERIAL	DESCRIPTION
	FIRST USED ON	ASSY USED ON	<div style="text-align: center;"> <p>WANG LABORATORIES, INC. TEMPERLEY, MASS. U.S.A.</p> </div>		
			MATERIAL	MODEL NO 623/723, 624/724, 2224	SI ENGR SPECIFICATIONS No
			FINISH	TOL. EX. AS NOTED XX ± 010 FRAC ± 1/64 XXX ± 005 ANG ± 1'30" FINISH V	
				SCALE	SHT OF
				WANG PART NUMBER	SIZE
				DRAWING NUMBER	REV

TITLE: BUFFER SCHEMATIC POWER SUPPLY 6281
 BY: OWN JB
 DATE: 12/27/74
 APPROVED BY: E ENGR
 DATE: 1-17-75
 M ENGR
 MFG ENGR
 TITLE: C 6281-1 4

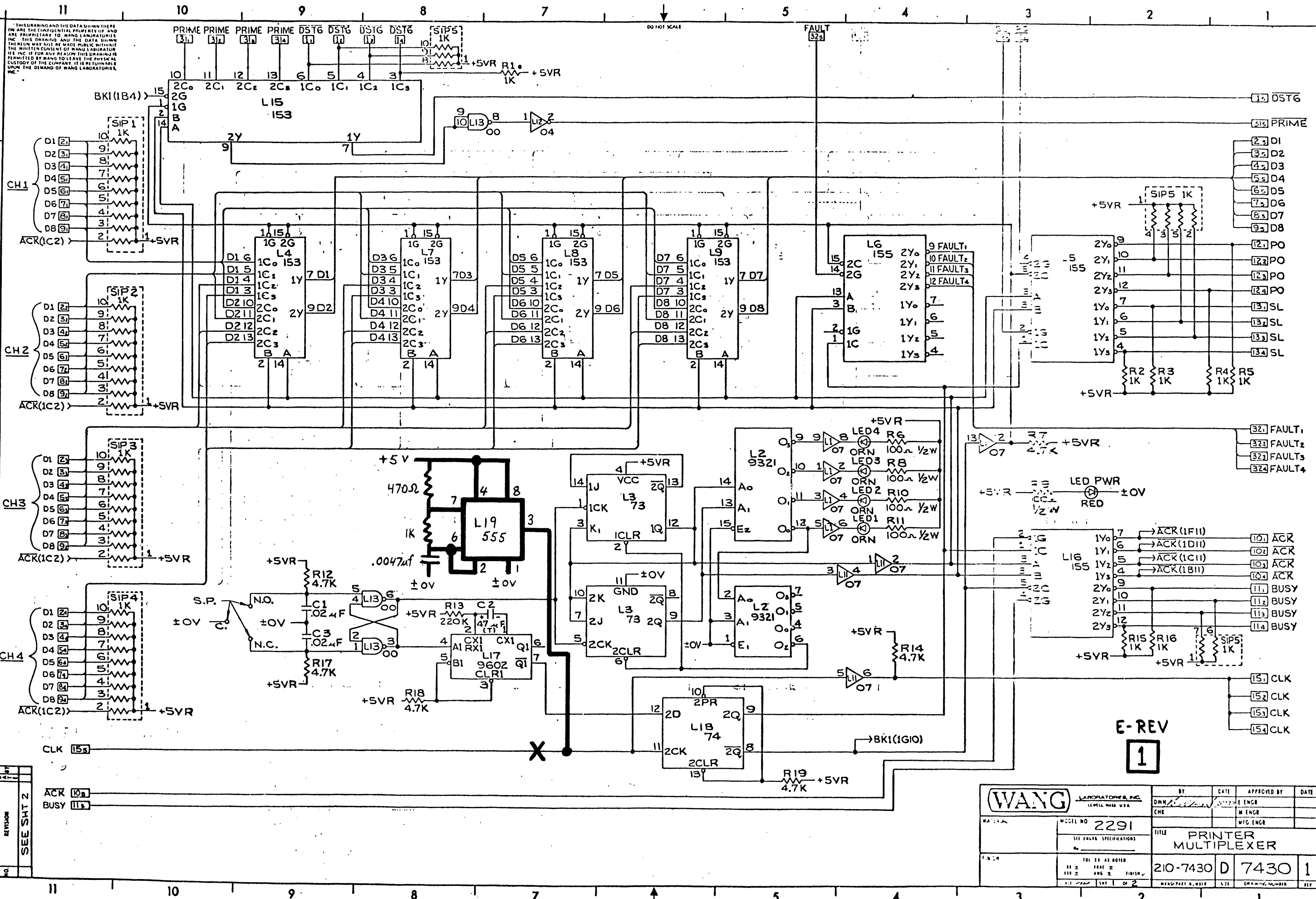

THIS DRAWING AND THE DATA SHOWN THEREON ARE THE CONFIDENTIAL PROPERTY OF WANG LABORATORIES, INC. THIS DRAWING AND THE DATA SHOWN HEREIN MAY NOT BE MADE PUBLIC WITHOUT THE WRITTEN CONSENT OF WANG LABORATORIES, INC. IF FOR ANY REASON THIS DRAWING IS PERMITTED BY WANG TO LEAVE THE PHYSICAL CUSTODY OF THE COMPANY, IT IS TO REMAIN UPON THE DEMAND OF WANG LABORATORIES, INC.

E-REV
1

WANG LABORATORIES, INC. LOWELL, MASS. U.S.A.		BY: <i>[Signature]</i>	DATE: <i>[Date]</i>	APPROVED BY: <i>[Signature]</i>	DATE: <i>[Date]</i>
MODEL NO. 2291		DRN: <i>[Signature]</i>	ENGR: <i>[Signature]</i>		
SEE ENGR SPECIFICATIONS		CHE: <i>[Signature]</i>	M ENGR: <i>[Signature]</i>		
TITLE: PRINTER MULTIPLEXER					
210-7430 D					
7430 1					

REVISION
SEE SHT 2

THIS DRAWING AND THE DATA SHOWN THERE ON ARE THE CONFIDENTIAL PROPERTY OF AND ARE PROPRIETARY TO WANG LABORATORIES, INC. THIS DRAWING AND THE DATA SHOWN THEREON MAY NOT BE MADE PUBLIC WITHOUT THE WRITTEN CONSENT OF WANG LABORATORIES, INC. IF FOR ANY REASON THIS DRAWING IS PERMITTED BY WANG TO LEAVE THE PHYSICAL CUSTODY OF THE COMPANY, IT IS RETURNABLE UPON THE DEMAND OF WANG LABORATORIES, INC.

I.C. LOCATION	TYPE	W.L. NO.
L1,11	7407	376-0056
L2	9321	376-0096
L3	7473	376-0005
L4,7-9,15	74153	376-0048
L5,6,16	74155	376-0049
L10	SPARE	
L12	7404	376-0010
L13	7400	376-0002
L14	SPARE	
L17	9602	376-0104
L18	7474	376-0006
L19	SPARE	

I.C. LOCATION	TYPE	SPARES
L11	7407	2
L12	7404	5
L13	7400	1
L17	9602	1
L18	7474	1

MNEMONIC	COORDINATE
ACK	1A11,1C1
BUSY	1A11,1C1
CLK	1B11,1B1
D1-8	1B11,1D11,1E11,1F11,1F1
DST6	1G9,1G1
FAULT	1G5
PO	1G3,1F1
PRIME	1G10
SL	1G3,1E1
PRIME	1G1
FAULT, -FAULT	1D1

COMPONENT	TYPE	W.L. NO.
R1-5,15,16	1K 10% 1/4W	330-3010
R6,8-11	100Ω 10% 1/2W	331-2010
R7,12,14,17-19	4.7K 10% 1/4W	330-3047
R13	220K 10% 1/4W	330-5022
SIP1-5	1K 9/PKG	333-0837
C1,3	.02μF 25V	300-1904
C2	47 μF 15V(T)	300-4020
C4	15 μF 20V(T)	300-4022
C5-12	.05μF 12V	300-1900
LED1-4	LAMP ORN	370-0027
LED PWR	LAMP RED	370-0026
J1-5	36PIN CONN	350-0085

NO.	REVISION	BY	DATE
1	ORIGINATED PER	25A	11-15-79
2	APPROVED PER	25A	11-15-79
3	ADD'D: 11/15/79		
4	REV PER ECN		
5	11/22/APPD:		
6	11/22/APPD:		

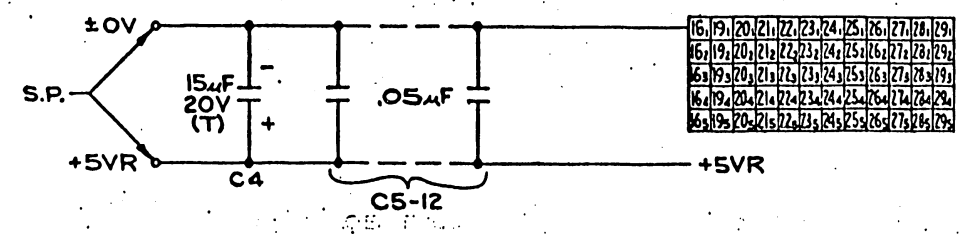
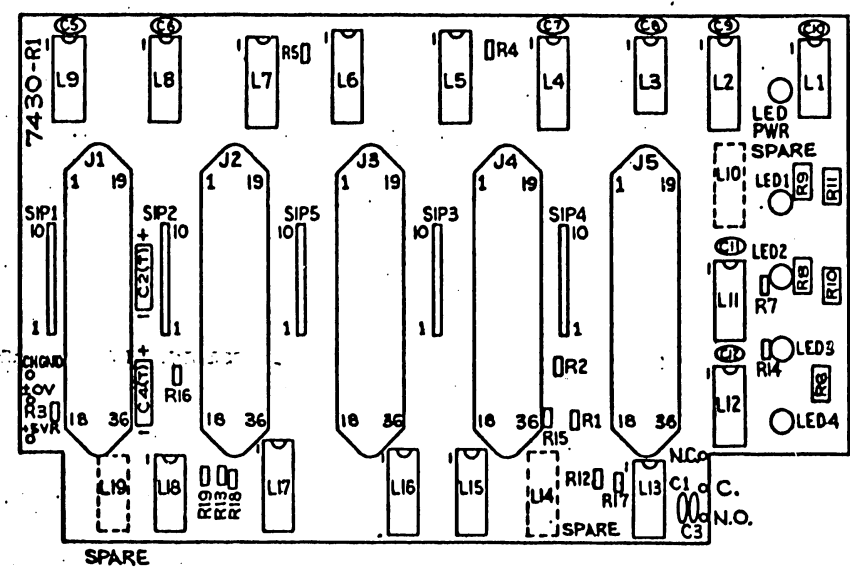
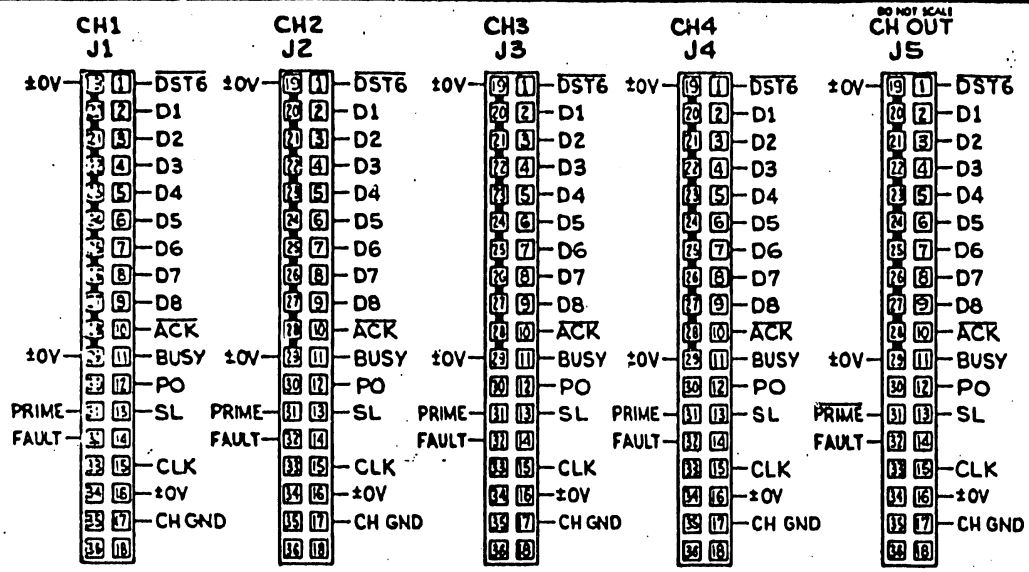

E REV
O

WANG LABORATORIES, INC. LOWELL, MASS. USA		BY DWN	DATE 5/27/79	APPROVED BY E ENGR	DATE 11-15-79
MATERIAL		MODEL NO. 2291	TITLE PRINTER MULTIPLEXER		
FINISH		210-7430 D		7430	1
SCALE 1/8" = 1"		SHEET 2 OF 2		WANG PART NUMBER	REV

G
F
E
D 7430
B
A

United States

Alabama Birmingham Mobile	Florida Miami Hialeah Jacksonville Orlando Tampa	Louisiana Baton Rouge Metairie	New Hampshire Manchester	Oregon Eugene Portland	Vermont Montpelier
Alaska Anchorage		Maryland Rockville Towson	New Jersey Toms River Mountainside Clifton	Pennsylvania Allentown Camp Hill Erie Philadelphia Pittsburgh Wayne	Virginia Newport News Norfolk Richmond
Arizona Phoenix Tucson	Georgia Atlanta Savannah	Massachusetts Billerica Boston Burlington Chelmsford Lawrence Littleton Lowell Tewksbury Worcester	New Mexico Albuquerque		Washington Richland Seattle Spokane Tacoma
California Culver City Fountain Valley Fresno Inglewood Sacramento San Diego San Francisco Santa Clara Ventura	Hawaii Honolulu	Michigan Kentwood Okemos Southfield	New York Albany Buffalo Fairport Lake Success New York City Syracuse	Rhode Island Cranston	Wisconsin Brookfield Madison Wauwatosa
Colorado Englewood	Idaho Idaho Falls	Minnesota Eden Prairie	North Carolina Charlotte Greensboro Raleigh	South Carolina Charleston Columbia	
Connecticut New Haven Stamford Wethersfield	Illinois Chicago Morton Park Ridge Rock Island Rosemont	Missouri Creve Coeur	Ohio Cincinnati Cleveland Middleburg Heights Toledo Worthington	Tennessee Chattanooga Knoxville Memphis Nashville	
District of Columbia Washington	Indiana Indianapolis South Bend	Nebraska Omaha	Oklahoma Oklahoma City Tulsa	Texas Austin Dallas Houston San Antonio	
	Kansas Overland Park Wichita	Nevada Las Vegas Reno		Utah Salt Lake City	

International Offices

Australia Wang Computer Pty., Ltd. Adelaide, S.A. Brisbane, Qld. Canberra, A.C.T. Darwin N.T. Perth, W.A. South Melbourne, Vic 3 Sydney, NSW	France Wang France S.A.R.L. Paris Bordeaux Lyon Marseilles Nantes Strasbourg Toulouse	Singapore Wang Computer (Pte) Ltd. Singapore
Austria Wang Gesellschaft, m.b.H. Vienna	Great Britain Wang (U.K.) Ltd. Richmond Birmingham London Manchester Northwood Hills	Sweden Wang Skandinaviska AB Stockholm Gothenburg Malmo
Belgium Wang Europe, S.A. Brussels Erpe-Mere	Hong Kong Wang Pacific Ltd. Hong Kong	Switzerland Wang A.G. Zurich Basel Geneva
Canada Wang Laboratories (Canada) Ltd. Burnaby, B.C. Calgary, Alberta Don Mills, Ontario Edmonton, Alberta Hamilton, Ontario Montreal, Quebec Ottawa, Ontario Winnipeg, Manitoba	Japan Wang Computer Ltd. Tokyo	Wang Trading A.G. Zug
China Wang Industrial Co., Ltd. Taipei Wang Laboratories Ltd Taipei	Netherlands Wang Nederland B.V. IJsselstein Gronigen	United States Wang International Trade, Inc. Lowell, Mass.
	New Zealand Wang Computer Ltd. Auckland Wellington	West Germany Wang Laboratories, GmbH Frankfurt Berlin Cologne Dusseldorf Essen Freiburg Hamburg Hannover Kassel Munich Nurnberg Saarbrucken Stuttgart

International Representatives

Abu-Dhabi Argentina Bahrain Bolivia Brazil Canary Islands Chile Colombia Costa Rica Cyprus Denmark Dominican Republic Ecuador Egypt El Salvador Finland Ghana Greece Guatemala Haiti Honduras Iceland India Indonesia Ireland Israel Italy Jamaica Japan Jordan	Kenya Korea Kuwait Lebanon Liberia Malaysia Malta Mexico Morocco Nicaragua Nigeria Norway Paraguay Peru Philippines Portugal Saudi Arabia Scotland Spain Sri Lanka Sudan Syria Thailand Turkey United Arab Emirates Venezuela
--	---

WANG

LABORATORIES, INC.

ONE INDUSTRIAL AVENUE, LOWELL, MASSACHUSETTS 01851, TEL. (617) 459-5000, TWX 710 343-6769, TELEX 94-7421

Printed in U.S.A.
13-6339
1-80-5M

END